

(1:1)

Execution: Press-Fit
Surface coating 5-10µm Sn on 2-4µm Cu

(PROJECTION)		(TOLERANCES)		(SURFACE)	SCALE	2:1	TOTAL WEIGHT: 1,6 g
		DIN ISO 2768-m			(MATERIAL)	CuZn39Pb3	WEIGHT Cu: 0,0091 g WEIGHT Sn: 0,0186 g
			DATE	NAME	(TITLE)		
		DRAWN	2009/07/14	Dino Cantara			
		VERIFIED	2009/07/14	Heiko Schmid			
					(DRAWING NUMBER)	7461094	Sheet 1
							1
ISSUE	CHANGE	DATE	NAME	CONFIDENTIAL !! ALL RIGHTS RESERVED. Passing on or duplication without prior written agreement prohibited.			



1

2

3

4

A

Drill hole specification for chemical surfaces

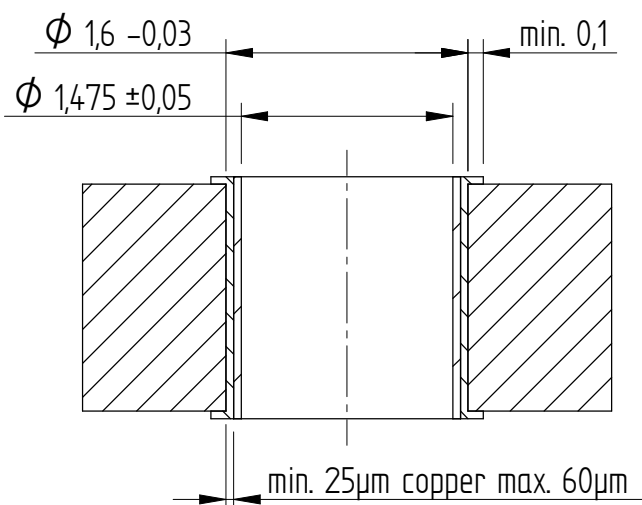

B

C

Drill hole specification for HAL

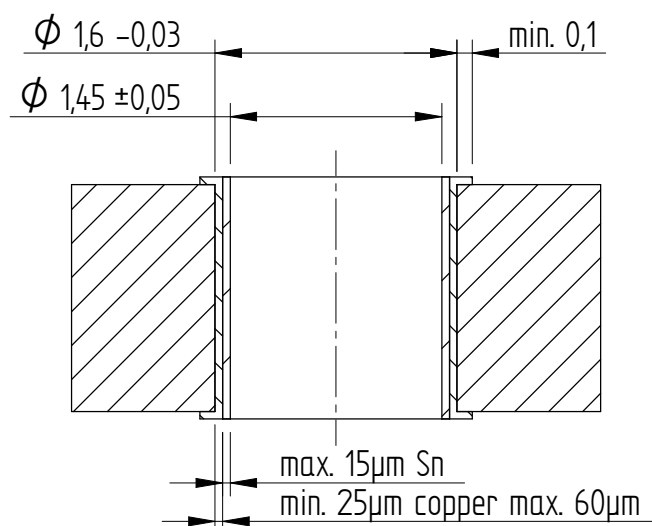

D

E

This electronic component is designed and developed with the intention for use in general electronics equipments. Before incorporating the components into any equipments in the field such as aerospace, aviation, nuclear control, submarine, transportation, (automotive control, train control, ship control), transportation signal, disaster prevention, medical, public information network etc. where high safety and reliability are especially required or if there is possibility of direct damage or injury to human body, Würth Elektronik must be asked for a written approval. In addition, even electronic component in general electronic equipments, when used in electrical circuits that require high safety, reliability functions or performance, the sufficient reliability evaluation-check for the safety must be performed before by the user before usage.

F

(PROJECTION)

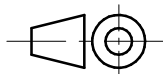

(TOLERANCES)

DIN ISO 2768-m

(SURFACE)

SCALE 20:1

(MATERIAL)

	DATE	NAME
DRAWN	2013/08/27	Dino Cantara
VERIFIED	2013/08/27	Wladimir Werz

(TITLE)

Power Elements Specification
Press-fit system

(DRAWING NUMBER)



Sheet 1

1

ISSUE	CHANGE	DATE	NAME

CONFIDENTIAL !! ALL RIGHTS RESERVED. Passing on or duplication without prior written agreement prohibited.