



# EasySync Ltd

## USB2-F-1001 Full-Speed USB to 1-Port RS232 Adapter

### Data Sheet

**Document Reference No.: ES\_000004**

**Version 1.1**

**Issue Date: 2009-02-25**

The USB-COM-Plus adaptors are a family of communication devices from EasySync Ltd. This model, USB2-F-1001, provides a simple method of adapting legacy serial devices with RS232 interfaces to modern USB ports by incorporating the FTDI FT232R bridge chip.

**A power supply output of +5VDC @ up to 250mA is available on the 9-pin D-sub connector. Flexible mounting options allow the USB2-F-1001 to be used in a variety of applications. Indicator LEDs provide functional status.**

**EasySync Ltd**

**Unit 1, 2 Seaward Place, Centurion Business Park, Glasgow, G41 1HH, United Kingdom**

**Tel.: +44 (0) 141 418 0181 Fax: + 44 (0) 141 418 0110**

**E-Mail (Support): [support@easysync.co.uk](mailto:support@easysync.co.uk) Web: <http://www.easysync.co.uk>**

Neither the whole nor any part of the information contained in, or the product described in this manual, may be adapted or reproduced in any material or electronic form without the prior written consent of the copyright holder. This product and its documentation are supplied on an as-is basis and no warranty as to their suitability for any particular purpose is either made or implied. EasySync Ltd will not accept any claim for damages howsoever arising as a result of use or failure of this product. Your statutory rights are not affected. This product or any variant of it is not intended for use in any medical appliance, device or system in which the failure of the product might reasonably be expected to result in personal injury. This document provides preliminary information that may be subject to change without notice. No freedom to use patents or other intellectual property rights is implied by the publication of this document. EasySync Ltd, Unit 1, 2 Seaward Place, Centurion Business Park, Glasgow, G41 1HH, United Kingdom. Scotland Registered Number: SC224924

<b>1</b>	<b>Introduction .....</b>	<b>4</b>
1.1	<b>Functional Description .....</b>	<b>4</b>
1.2	<b>LED Description.....</b>	<b>5</b>
1.3	<b>Block Diagram.....</b>	<b>5</b>
1.3.1	Block description .....	5
1.4	<b>Features.....</b>	<b>6</b>
1.5	<b>Performance Figures .....</b>	<b>6</b>
1.6	<b>Ordering Information.....</b>	<b>7</b>
<b>2</b>	<b>Installation.....</b>	<b>8</b>
2.1	<b>Example Applications and Configurations .....</b>	<b>8</b>
2.2	<b>Hardware Installation .....</b>	<b>8</b>
2.2.1	Mounting.....	8
2.2.2	Wiring.....	8
2.3	<b>Device Driver Installation .....</b>	<b>9</b>
2.3.1	Microsoft Windows.....	10
2.3.2	Mac OS X, Linux, Windows CE.....	13
2.4	<b>Configuration Utility.....</b>	<b>14</b>
<b>3</b>	<b>Connections.....</b>	<b>16</b>
3.1	<b>External Connectors .....</b>	<b>16</b>
3.1.1	USB.....	16
3.1.2	RS232.....	16
<b>4</b>	<b>Electrical details .....</b>	<b>17</b>
4.1	<b>USB .....</b>	<b>17</b>
4.2	<b>RS232 .....</b>	<b>17</b>
4.3	<b>Power Output.....</b>	<b>17</b>
<b>5</b>	<b>Mechanical Details.....</b>	<b>18</b>
5.1	<b>Module Mechanical Dimensions.....</b>	<b>18</b>
5.2	<b>UniClip™ Mechanical Dimensions .....</b>	<b>19</b>
<b>6</b>	<b>Physical Environment Details .....</b>	<b>20</b>
6.1	<b>Storage .....</b>	<b>20</b>
6.2	<b>Operating.....</b>	<b>20</b>
<b>7</b>	<b>Environmental Approvals &amp; Declarations.....</b>	<b>21</b>
7.1	<b>EMI Compatibility.....</b>	<b>21</b>
7.2	<b>Safety .....</b>	<b>21</b>
7.3	<b>Environmental.....</b>	<b>21</b>
7.4	<b>Reliability.....</b>	<b>21</b>

---

7.4.1	MTTF .....	21
<b>7.5</b>	<b>Import / Export Information.....</b>	<b>22</b>
<b>8</b>	<b>Troubleshooting .....</b>	<b>23</b>
<b>8.1</b>	<b>Hardware .....</b>	<b>23</b>
<b>8.2</b>	<b>Device Driver .....</b>	<b>23</b>
<b>8.3</b>	<b>Technical Support .....</b>	<b>24</b>
<b>9</b>	<b>Contact Information .....</b>	<b>25</b>
<b>Appendix A - List of Figures and Tables .....</b>		<b>26</b>
<b>Appendix B - Revision History .....</b>		<b>28</b>

## 1 Introduction

### 1.1 Functional Description

The USB-COM-Plus adaptors are a family of communication devices. This model, USB2-F-1001, provides a simple method of adapting legacy serial devices with RS232 interfaces to modern USB ports. This is accomplished by incorporating the industry standard FTDI FT232R USB-Serial bridge chip.

Each USB2-F-1001 adapter contains a small internal electronic circuit board which utilises the FTDI FT232R, mounted inside a rugged plastic enclosure capable of withstanding industrial temperature ranges. The integrated electronics also include RS232 level shifters and TXD/RXD LEDs to provide a visual indication of data traffic through the adapter.



**Figure 1.1 USB-COM-Plus USB2-F-1001**

Flexible mounting allows the USB2-F-1001 to be used in a variety of applications, from a portable adapter to accompany a laptop to permanent installations in industrial, commercial and retail locations.

The enclosure incorporates a standard USB-B device connector for connection to an upstream host or hub port. RS232-level signals, including modem handshake signals, are available on an industry-standard DE-9P connector. The maximum RS232-level data rate is 1Mbps.

The USB2-F-1001 adapter require USB device drivers, available free from <http://www.easysync.co.uk> or <http://www.easysync-ltd.com>, which are used to make the USB2-F-1001 appear as a Virtual COM Port (VCP). This allows existing serial communications software, such as HyperTerminal, to exchange data through the USB2-F-1001 to a legacy RS232 peripheral device.

In addition to the device drivers, a configuration utility is available to change the definition of Pin 9 of the D-sub connector. The USB-COM-Plus Configuration Utility is available free from <http://www.easysync.co.uk> or <http://www.easysync-ltd.com>,

## 1.2 LED Description

The USB2-F-1001 uses three LEDs to indicate a valid link as well as data traffic according to the following table:

LED Color	Function	Description
Yellow	Enumerated	ON when USB-COM-Plus is configured and ready
Green	TxD Activity	Flashes when data is transmitted from the USB2-F-1001 to the attached RS232 device
Red	RxD Activity	Flashes when data is transmitted from the attached RS232 device to the USB2-F-1001

**Table 1.1 – LED Description**

## 1.3 Block Diagram

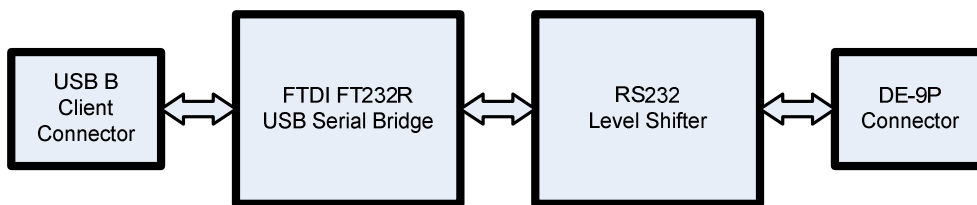

**Figure 1.2 USB2-F-1001 Block Diagram**

### 1.3.1 Block description

#### **USB B Client Connector**

This connector provides the interface for connection to a USB Host or Hub port. A standard “A to B” cable is provided, though one of a different length may also be used. The maximum cable length is 5 meters, according to the USB 2.0 specification.

#### **FTDI FT232R**

The FTDI FT232R provides the USB-to-Serial conversion. Operating system device drivers are required in order to work with the FT232R to provide the Virtual COM Port serial functionality.

#### **RS232 Level Shifter**

The RS232 level shifter converts the signals provided by the FT232R into the voltage levels required by RS232 devices.

#### **DE-9P Connector (Male)**

The DE-9P connector is configured in an industry standard (TIA/EIA-574) pin-out to provide connection to RS232 peripherals through standard cables. See section 3.1.2

## 1.4 Features

- Adds one RS-232 serial port by connecting to USB
- Easy plug & play installation and RS-232 device connection
- Works with USB 1.1 & 2.0 Host and Hub ports
- Industry Standard FTDI chip set & device drivers for maximum compatibility
- Microsoft Windows® WHQL-certified, Mac OS X, Linux and Windows CE device drivers
- Installs as a standard Windows COM port
- COM port number can be changed to any available COM port number, including COM1 to COM4, to support HyperTerminal, or any other serial communications software application running in Windows
- Supports Windows Server 2008, 2003, Vista, XP 2000, Linux, Mac OS X
- FIFO: 128 byte transmit buffer, 256 byte receive buffer
- RS-232 data signals: TxD, RxD, RTS, CTS, DSR, DTR, DCD, RI, GND
- Powered by USB port. No external power adapter required.
- RI signal can be configured for +5VDC output at 250mA
- Serial port speed up to 1Mbps
- Serial Communication Parameters
  - Parity: None, Even, Odd
  - Data bits: 7, 8
  - Flow control: RTS/CTS , DSR/DTR, X-ON/X-OFF, None
- One DE-9P male connector
- LEDs indicate USB Enumeration, RxD, TxD for monitoring port status & easy diagnostics
- High-temperature plastic enclosure
- Operating temperature of -40°C to +85°C
- USB cable of 0.9 meter included

## 1.5 Performance Figures

Parameter	Performance
USB Interface	12Mbps USB 2.0 Full-Speed
RS232 Interface	Standard Windows baud rates (300bps to 921.6Kbps) Custom baud rates (300bps to 1Mbps) through baud rate aliasing. See FTDI Application Note: <a href="#">Configuring FT232R, FT2232 and FT232BM Baud Rates</a>

**Table 1.2 - Performance Figures**

## 1.6 Ordering Information

Part Number	Description
USB2-F-1001	USB-COM-Plus Full-Speed USB to 1-Port RS232 Adapter

**Table 1.3 - Ordering Information**

## 2 Installation

### 2.1 Example Applications and Configurations

### 2.2 Hardware Installation

There are no switches or jumpers to configure on the USB-COM-Plus USB2-F-1001.

#### 2.2.1 Mounting

The USB2-F-1001 is provided with two mounting options: UniClip™ Wall/DIN rail mount and rubber feet. The UniClip Wall/DIN rail mount allows the USB2-F-1001 to be permanently mounted to a wall or attached to a DIN rail. The rubber feet can be used when mobility or desktop use is desired. NOTE: The UniClip provides a permanent mounting style. The USB2-F-1001 case may be damaged if the UniClip is removed.

The following figures indicate various mounting styles.

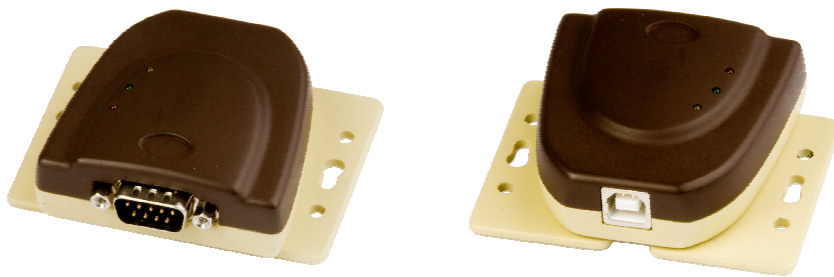

Figure 2.1 - USB2-F-1001 with UniClip Brackets



Figure 2.2 - USB2-F-1001 with Rubber Feet

#### 2.2.2 Wiring

A standard 0.9m USB "A" to "B" cable is provided.

Insert the A-plug into an available USB Host or Hub port. Insert the B-plug into the B-receptacle on the USB2-F-1001.

RS232 cables have followed a standard 9-pin configuration on a D-sub connector since the mid 1980s. The USB2-F-1001 follows this standard as a Data Terminal Equipment (DTE) device. If the RS232



equipment being connected is a Data Communication Equipment (DCE) device, it's typical that a straight-through cable can be used.

DTE Pin Number	Signal Name	DCE Pin Number
1	DCD = Data Carrier Detect	1
2	RXD = Receive Data	2
3	TXD = Transmit Data	3
4	DTR = Data Terminal Ready	4
5	GND = RS232 signal ground	5
6	DSR = Data Set Ready	6
7	RTS = Request To Send	7
8	CTS = Clear To Send	8
9	RI - Ring Indicator / +5VDC	9

**Table 2.1 – RS232 DTE to DCE connection with straight-through cable**

If the USB2-F-1001 is connected to another DTE device, a serial “null-modem” cable is required. A null-modem handles connecting output signals to the corresponding input signals on the other end. Table 2.3 shows a typical null-modem cable. Note that RI and DCD are not always used.

DTE Pin Number	Signal Name	DTE Pin Number
2	RXD = Receive Data	3
3	TXD = Transmit Data	2
4	DTR = Data Terminal Ready	6
5	GND = RS232 signal ground	5
6	DSR = Data Set Ready	4
7	RTS = Request To Send	8
8	CTS = Clear To Send	7

**Table 2.2 – RS232 DTE to DTE connection with null-modem cable**

Some serial devices may require certain handshake signals be connected. Refer to your device manual for cabling details.

## 2.3 Device Driver Installation

The USB2-F-1001 adaptor drivers are available for download from:

[www.easysync.co.uk](http://www.easysync.co.uk) – United Kingdom site

[www.easysync-ltd.com](http://www.easysync-ltd.com) – USA site

### 2.3.1 Microsoft Windows

With the device drivers being Windows Hardware Quality Labs (WHQL) certified, they are also available through download directly from the Microsoft® Windows® Update service. This is the best choice when connecting the USB2-F-1001 to a computer running Windows Vista. Additional installation options are noted below:

#### **Installation Executable on Windows XP**

- 1) Login to your system as Administrator, or a user with Administrator rights.
- 2) Prior to connecting the USB2-F-1001 to the USB Host or Hub port, download the latest device driver version from the EasySync web site.
- 3) Run this executable to install the device drivers.
- 4) Connect the USB2-F-1001 to your computer. A notification will appear near the task bar indicating that new hardware has been installed and is ready for use. It is normal if this notice appears twice.

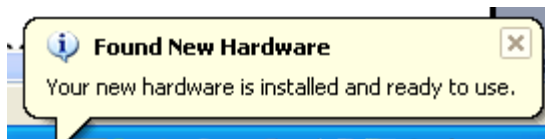

**Figure 2.3 - Hardware Ready**

#### **Windows Update shown on Windows XP**

You must have an active Internet connection and the Windows Update Service enabled.

- 1) Connect the USB2-F-1001 to your USB Host or Hub.
- 2) The "Found New Hardware" Wizard will appear. The first dialog should ask whether it is acceptable to use the Windows Update Service to find the device driver.



**Figure 2.4 – Found New Hardware Wizard**

- 3) Select one of the "Yes" choices and click "Next".
- 4) The following screen appears:

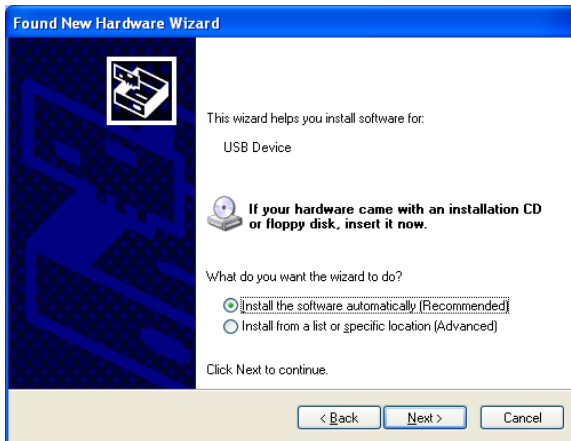

**Figure 2.5 – Automatic Install**

- 5) Wait while the driver is found, downloaded, and installed. This step may take a couple minutes depending on the Internet speed.
- 6) After the files are found and installed, click “Finish” to complete the installation.

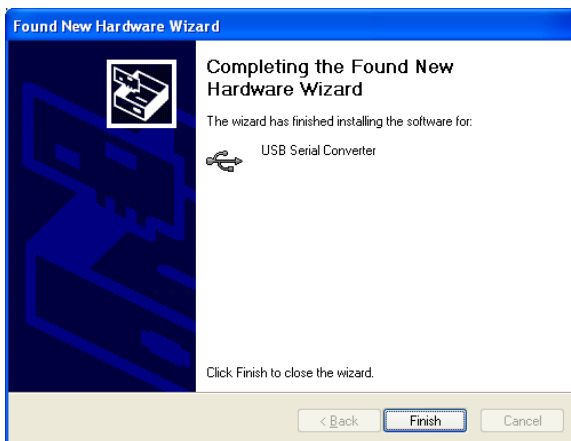

**Figure 2.6 - Complete Hardware Installation**

- 7) Steps 2 through 6 will repeat. The first time installs the basic USB Serial Converter in the USB device tree. The second time installs the Virtual COM Port layer in the Ports tree and assigns the COM port number.
- 8) When both portions of the device driver have been installed successfully, the following message will appear, indicating that the device is ready.

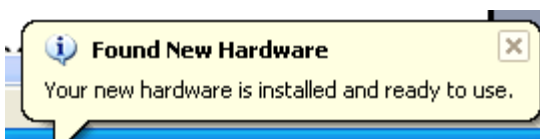

**Figure 2.7 - Hardware Ready**

### **COM Port Assignment**

Next, to determine which COM port has been assigned, open the Windows Device Manager from the System Control Panel.

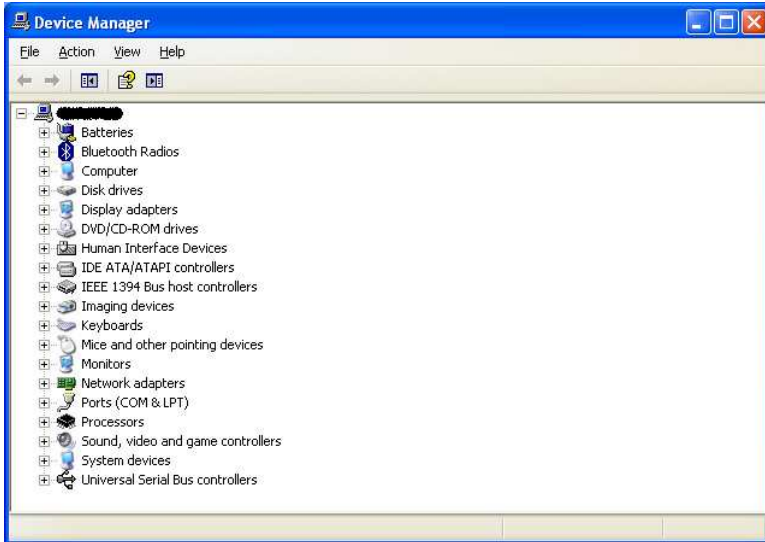

**Figure 2.8 - Device Manager**

Click on the Plus “+” sign next to the Ports tree to list the available COM port. You will see “EasySync USB COM Port”, followed by a COMn assignment. In the figure below, the USB2-F-1001 is assigned to COM3.



**Figure 2.9 - COM Port Assignment**

Use this COM port number with your application software in order to access the USB2-F-1001.

If an application requires use of a different COM port number, the assignment may be changed through the Advanced Driver Options settings.

From the Device Manager listing above, right-click on the EasySync USB COM Port and select Properties.



**Figure 2.10 – Access COM Port Properties**

Next, click on the “Port Settings” tab.



**Figure 2.11 - Settings Tab**

Then click on the "Advanced..." button.

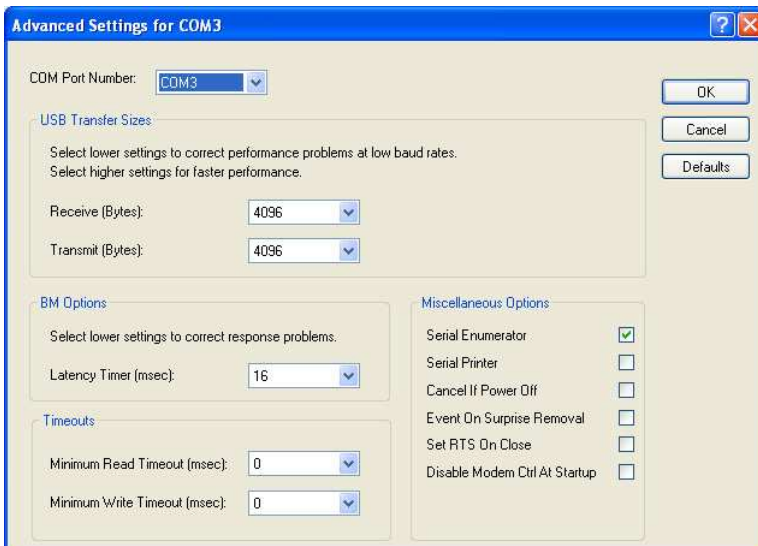

**Figure 2.12 - Advanced Options**

This will display the various advanced settings. Note the COM port assignment in the upper left. Clicking on the drop-down list will display the available port numbers. Select one that is not in use and click OK on each dialog box to activate the selection. Windows will remember this COM port number.

### 2.3.2 Mac OS X, Linux, Windows CE

Device drivers and FTDI installation guides for Mac OS X, Linux and Windows CE are available for download on the EasySync web sites. Follow the respective FTDI installation guides for the chosen operating system.

## 2.4 Configuration Utility

A utility to which configures the function of Pin 9 of the D-sub connector on the USB2-F-1001 configuration utility is available for download from the EasySync website (see contact information)

The configuration utility is a Windows-only application which selects the mode for pin 9 on the D-sub connector. This utility will configure one USB2-F-1001 adapter at a time. Ensure an adapter is connected to your PC and run the utility:

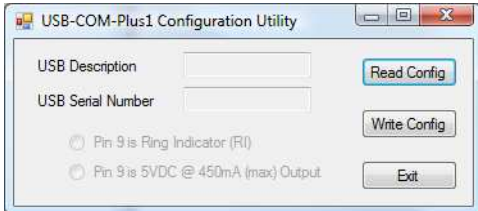

**Figure 2.13 – Pin 9 Configuration Utility**

The current configuration must be read before modifying the settings. Click on the “Read Config” button. A notice will appear if successful:

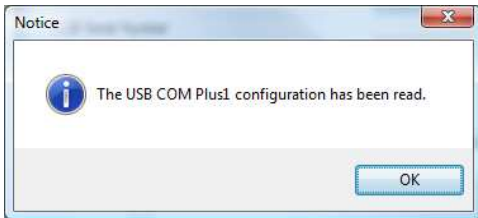

**Figure 2.14 – Pin 9 Configuration Utility – Read Configuration**

The current configuration is displayed, including the adapter description and serial number:

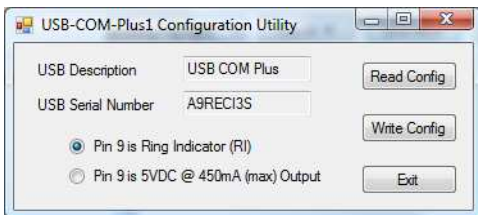

**Figure 2.15 – Pin 9 Configuration Utility – Display Current Settings**

Select whether to change the function of the D-sub pin 9, then click “Write Config”:

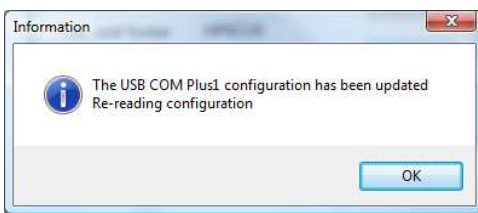

**Figure 2.16 – Pin 9 Configuration Utility – Write Configuration**

The new values will be read from the USB2-F-1001:

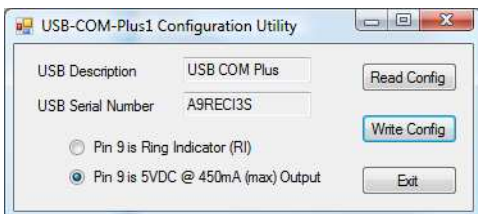

**Figure 2.17 – Pin 9 Configuration Utility – Read New Settings**

The adapter has been reconfigured. Press Exit:

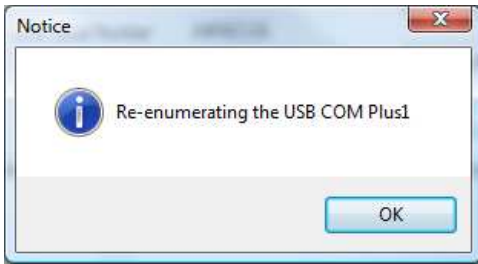

**Figure 2.18 - Pin 9 Configuration Utility – Exit Program**

The utility forces the adapter to re-enumerate on the USB bus, and then closes. The USB2-F-1001 is ready for use with its new settings.

### 3 Connections

#### 3.1 External Connectors

##### 3.1.1 USB

The USB-F-1001 is a downstream USB 2.0 Device. A standard USB Series "B" receptacle is mounted inside the USB-F-1001 to facilitate connection to an upstream USB Host or Hub.

Pin Number	Pin Type	Description
1	Power	VBUS – USB Power provided from upstream USB Host or Hub
2	Bidirectional	D- = USB data signal, negative polarity
3	Bidirectional	D+ = USB data signal, positive polarity
4	Ground	GND = USB signal ground
Shield	Case Ground	Drain = typically connected to the host PC case

**Table 3.1 – USB "B" Receptacle Pin-Out**

##### 3.1.2 RS232

The RS232 port is configured as Data Terminal Equipment (DTE), with a 9-contact D-Sub Pin connector. Pin assignments are according to TIA/EIA-574 which formally defines the assignments for a COM port found on many personal computers. In addition, Ring Indicator (RI) may be re-assigned to provide +5VDC to an external device with a maximum current draw of 250mA once the USB2-F-1001 has been enumerated by the system.

Pin Number	Pin Type	Description
1	Input	DCD = Data Carrier Detect
2	Input	RXD = Receive Data
3	Output	TXD = Transmit Data
4	Output	DTR = Data Terminal Ready
5	Ground	GND = RS232 signal ground
6	Input	DSR = Data Set Ready
7	Output	RTS = Request To Send
8	Input	CTS = Clear To Send
9	Input / Power	RI = Ring Indicator or +5VDC @ 250mA max
Shield	Case Ground	Drain = typically connected to the host PC case

**Table 3.2 – DE-9P RS232 Pin-Out**



## 4 Electrical details

### 4.1 USB

Parameter	Description	Minimum	Typical	Maximum	Units	Conditions
USB_VCC	Input Power Voltage*	4.25	5.0*	5.25	V	*Present when USB cable is attached and USB Host or Hub powered.
I <sub>cc</sub>	USB current***		30	50	mA	***Does not include power supplied to external device connected to pin 9 when configured for power output mode

**Table 4.1 - USB Electrical Details**

### 4.2 RS232

Parameter	Description	Minimum	Typical	Maximum	Units	Conditions
V <sub>trans</sub>	Transmitter output voltage swing	± 5			V	RL = 3KΩ
V <sub>rec</sub>	Receiver input voltage range	±2.4		±25	V	Input resistance = 3KΩ to 7KΩ
	ESD HBM		±15		KV	RS-232 Inputs and Outputs

**Table 4.2 - RS232 Electrical Details**

### 4.3 Power Output

The USB2-F-1001 can be re-configured to assign the RI pin (see section 3.1.2) to provide +5V DC for an external device that requires power. The maximum allowable current that can be supplied from the USB bus is 500mA, including the circuitry of the USB2-F-1001 itself. Up to 250mA may be used by the external device.

Parameter	Description	Minimum	Typical	Maximum	Units	Conditions
I <sub>o</sub>	Output Power Current	0		250	mA	USB2-F-1001

**Table 4.3 - Power Output Option**

## 5 Mechanical Details

### 5.1 Module Mechanical Dimensions

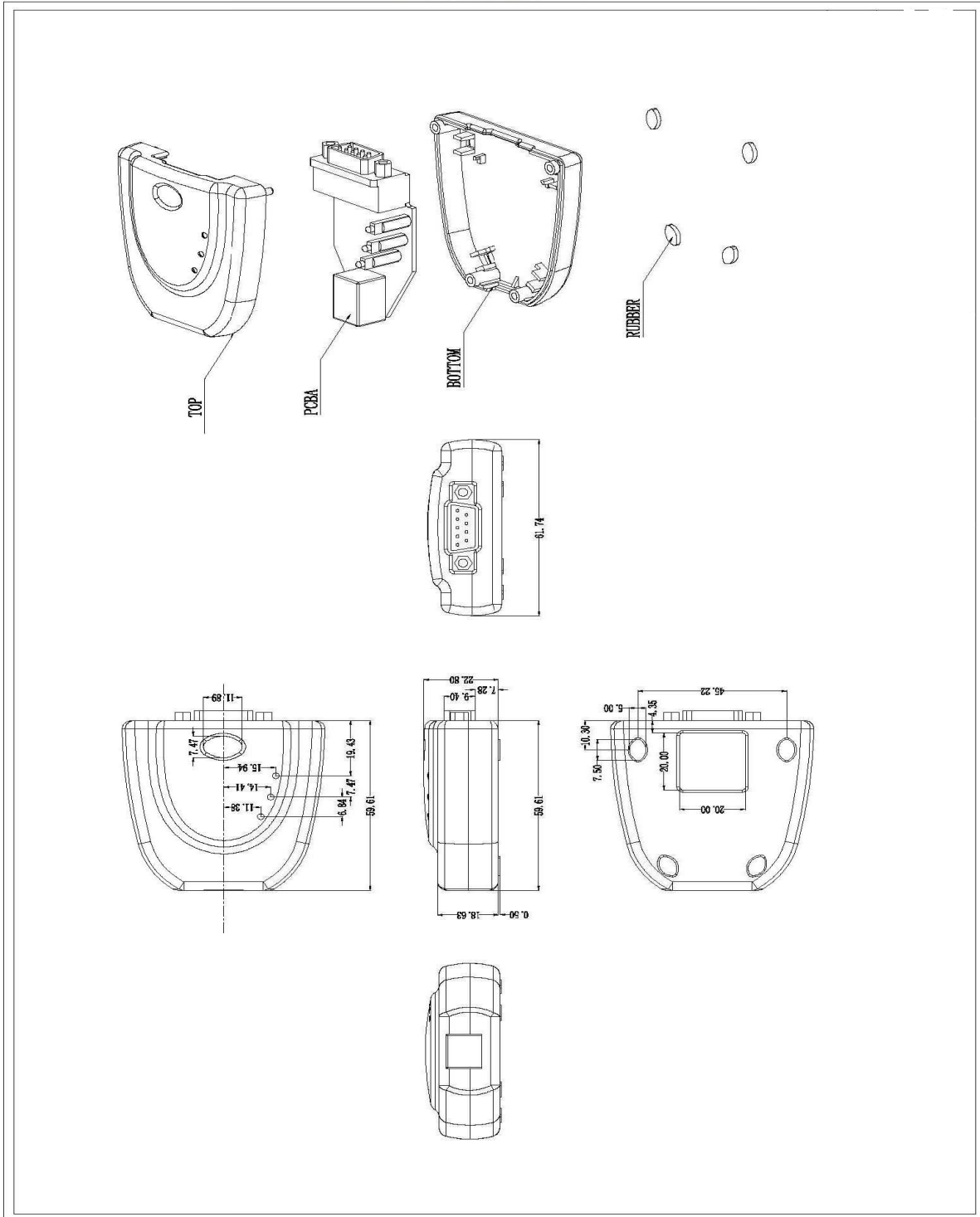

**Table 5.1 - USB2-F-1001 Case Dimensions**

## 5.2 UniClip™ Mechanical Dimensions

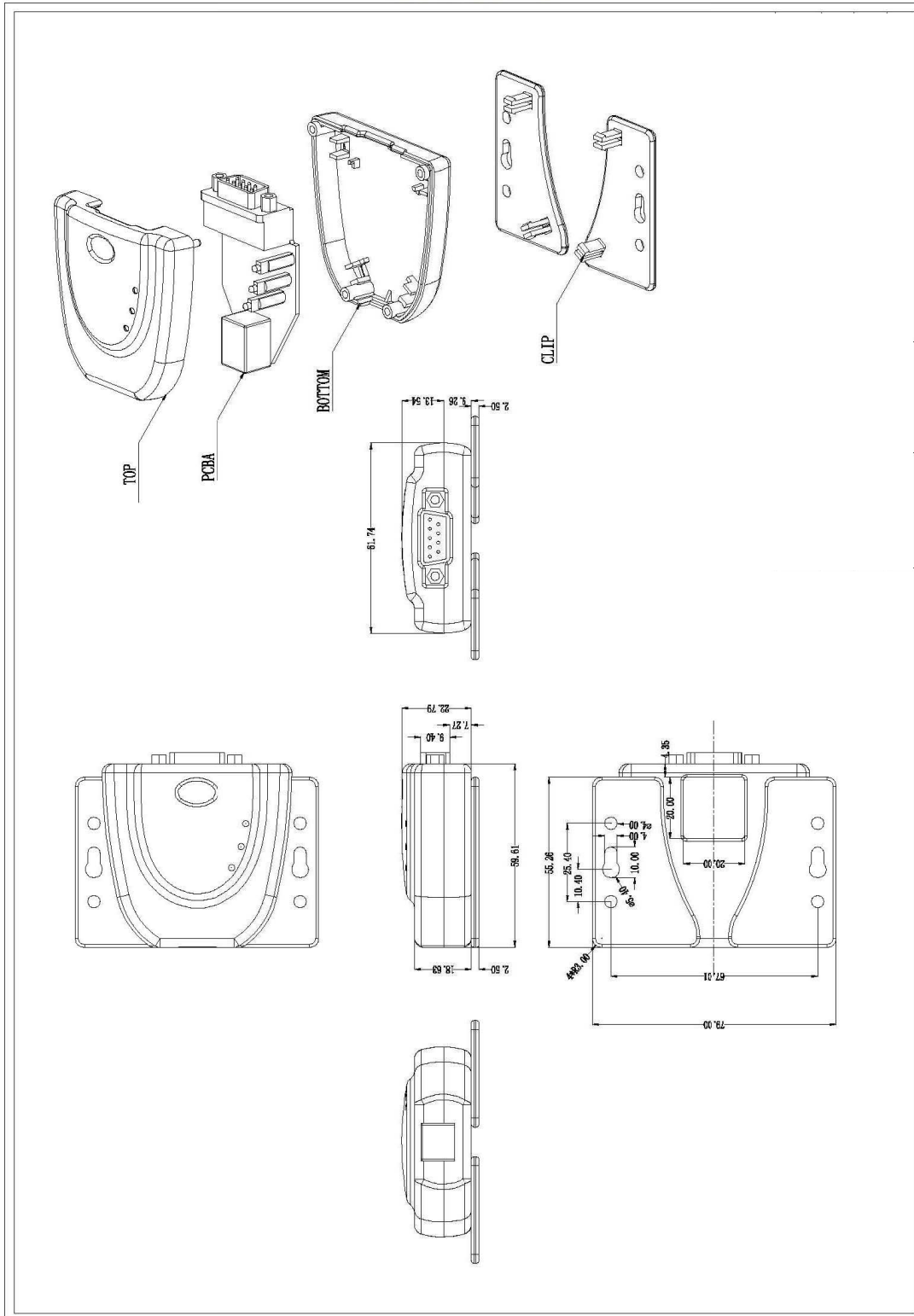

**Table 5.2 - USB2-F-1001 Case Dimensions with UniClip**

## 6 Physical Environment Details

### 6.1 Storage

Parameter	Description	Minimum	Typical	Maximum	Units	Conditions
T	Storage Temperature Range	TBD		TBD	°C	

**Table 6.1 - Storage Temperature**

### 6.2 Operating

Parameter	Description	Minimum	Typical	Maximum	Units	Conditions
T	Operating Temperature Range	-40		+85	°C	5% to 95% RH, non condensing

**Table 6.2 - Operating Temperature**

## 7 Environmental Approvals & Declarations

### 7.1 EMI Compatibility

#### FCC and CE

The USB2-F-1001 has been tested to be compliant with both FCC Part 15 Subpart B and European EMC Directive.



NOTE: This is a Class B product. In a domestic environment, this product may cause radio interference, in which case the user may be required to take adequate measures.

#### IEC60601

The USB2-F-1001 has been tested to be compliant with IEC60601-1-2: Medical electrical equipment - Part 1: General requirements for safety - 2, Collateral standard: Electromagnetic compatibility.



NOTE: This equipment has been tested and found to comply with the limits for a Class B digital device, pursuant to Part 15 of the FCC Rules. These limits are designed to provide reasonable protection against harmful interference in a residential installation. This equipment generates, uses and can radiate radio frequency energy and, if not installed and used in accordance with the instructions, may cause harmful interference to radio communications. However, there is no guarantee that interference will not occur in a particular installation. If this equipment does cause harmful interference to radio or television reception, which can be determined by turning the equipment off and on, the user is encouraged to try to correct the interference by one or more of the following measures:

- Reorient or relocate the receiving antenna.
- Increase the separation between the equipment and receiver.
- Connect the equipment into an outlet on a circuit different from that to which the receiver is connected.
- Consult the dealer or an experienced radio/TV technician for help.

### 7.2 Safety

The USB2-F-1001 is defined as Limited Power Supply (LPS) device, with operating voltages under 60VDC.

### 7.3 Environmental

The USB2-F-1001 is a lead-free device that complies with the following environmental directives: RoHS, WEEE, REACH, PFOS and DecaBDE.

### 7.4 Reliability

The USB2-F-1001 is designed as a robust USB-Serial adapter for use in many environments. There are no user-serviceable parts. Any failure will require a replacement of the unit.

#### 7.4.1 MTTF

The Mean Time To Failure is calculated at TBD hours.

## 7.5 Import / Export Information

Import / Export Information	
Country of Origin	China
Harmonized Code	8471.80.1000
Product Description	USB to RS232 Computer Adapter, Single Port
USA ECCN	EAR99 – No License Required

**Table 7.1 - Import / Export Information**

## 8 Troubleshooting

### 8.1 Hardware

Cables are the most common sources of trouble with external devices.

Check the following:

- USB cable is properly inserted at both ends
- Computer power is ON
- Computer is not in Sleep or Standby
- If a USB Hub is used, be sure it is set for "Self-Powered" operation
- If a USB Hub is used, be sure all cables are properly inserted
- If all the above are OK, the Yellow LED should be lit, indicating the device has been recognized by the USB subsystem.

RS232 cables – check the following:

- Output signals (TXD, RTS, DTR) are connected to the respective inputs (RXD, CTS, DSR) in each direction.
- Check for specific handshake requirements of your RS232 peripheral.
- If handshake signals are not used, ensure the application is set to "No Hardware Handshake", or equivalent.
- Test the port with a loop-back connector. Connect TXD to RXD, RTS to CTS and DTR to DSR. Use a simple terminal program to check that data is transmitted and received.

### 8.2 Device Driver

Ensure the latest device driver is in use. See [www.easysync.co.uk](http://www.easysync.co.uk) or [www.easysync-ltd.com](http://www.easysync-ltd.com).

If other devices with FTDI chips are installed in the system, check with all manufacturers of these devices for the latest device drivers.

See the FTDI installation guides for additional details: <http://ftdichip.com/Documents/InstallGuides.htm>

Common Windows Device Driver Troubles:

- **DEVICE TIMES OUT:** The default settings of the device driver assume typical data transfers of hundred to thousands or more bytes at a given time. Some applications, such as a GPS device, only send data in short packets, often only a few bytes. If this is the case, it may be necessary to adjust the drivers buffer size and/or latency timer to smaller values. These values can be adjusted through the Advanced driver options as noted in Figure 2.13. The buffer size can be reduced to 64 bytes. The latency timer can be set as low as 2ms. A setting of 1ms will cause unnecessary USB traffic and could adversely affect data transmission.
- **ERRATIC MOUSE POINTER:** The device driver defaults to query an attached device to find out whether it is a mouse or modem, consistent with native COM port operation. Some RS232 peripherals constantly send short packets of data, causing the host system to "think" a mouse or modem has been attached. These short packets will interfere with normal mouse operation causing the pointer to jump around the screen. If this happens, disconnect the RS232 device and *uncheck the Serial Enumerator* option, also found on the Advanced driver options screen in Figure 2.13.
- **COM PORT IN USE:** Windows keeps track of all COM port assignments. If multiple EasySync products have been connected to a single system, the COM port number will increase, even if the other devices are not attached. If the higher COM port assignments are not acceptable for the application, known unused COM port numbers should be uninstalled according to the FTDI installation guide: <http://ftdichip.com/Documents/InstallGuides.htm>.

### 8.3 Technical Support

Technical support may be obtained from your nearest EasySync office:

United Kingdom: [support@easysync.co.uk](mailto:support@easysync.co.uk)

United States: [support@easysync-ltd.com](mailto:support@easysync-ltd.com)



## 9 Contact Information

### Head Office – Glasgow, UK

EasySync Limited  
Unit 1, 2 Seaward Place,  
Centurion Business Park  
Glasgow, G41 1HH  
United Kingdom  
Tel: +44 (0) 141 418 0181  
Fax: +44 (0) 141 418 0110

E-mail (Sales)	<a href="mailto:sales@easysync.co.uk">sales@easysync.co.uk</a>
E-mail (Support)	<a href="mailto:support@easysync.co.uk">support@easysync.co.uk</a>
E-mail (General Enquiries)	<a href="mailto:admin@easysync.co.uk">admin@easysync.co.uk</a>
Web Site URL	<a href="http://easysync.co.uk">http://easysync.co.uk</a>
Web Shop URL	<a href="http://easysync.co.uk">http://easysync.co.uk</a>

### Branch Office – Hillsboro, Oregon, USA

EasySync Limited (USA)  
7235 NW Evergreen Parkway, Suite 600  
Hillsboro, OR 97123-5803  
USA  
Tel: +1 (503) 547 0909  
Fax: +1 (503) 547 0990

E-Mail (Sales)	<a href="mailto:sales@easysync-ltd.com">sales@easysync-ltd.com</a>
E-Mail (Support)	<a href="mailto:support@easysync-ltd.com">support@easysync-ltd.com</a>
E-Mail (General Inquiries)	<a href="mailto:admin@easysync-ltd.com">admin@easysync-ltd.com</a>
Web Site URL	<a href="http://easysync-ltd.com">http://easysync-ltd.com</a>
Web Shop URL	<a href="http://easysync-ltd.com">http://easysync-ltd.com</a>

## Appendix A - List of Figures and Tables

### List of Figures

Figure 1.1 USB-COM-Plus USB2-F-1001 .....	4
Figure 1.2 USB2-F-1001 Block Diagram .....	5
Figure 2.1 - USB2-F-1001 with UniClip Brackets .....	8
Figure 2.2 - USB2-F-1001 with Rubber Feet.....	8
Figure 2.3 - Hardware Ready .....	10
Figure 2.4 – Found New Hardware Wizard.....	10
Figure 2.5 – Automatic Install.....	11
Figure 2.6 - Complete Hardware Installation .....	11
Figure 2.7 - Hardware Ready .....	11
Figure 2.8 - Device Manager .....	12
Figure 2.9 - COM Port Assignment .....	12
Figure 2.10 – Access COM Port Properties .....	12
Figure 2.11 - Settings Tab.....	13
Figure 2.12 - Advanced Options.....	13
Figure 2.14 – Pin 9 Configuration Utility – Read Configuration.....	14
Figure 2.15 – Pin 9 Configuration Utility – Display Current Settings .....	14
Figure 2.16 – Pin 9 Configuration Utility – Write Configuration .....	14
Figure 2.17 – Pin 9 Configuration Utility – Read New Settings.....	14
Figure 2.18 - Pin 9 Configuration Utility – Exit Program .....	15

### List of Tables

Table 1.1 – LED Description .....	5
Table 1.2 - Performance Figures .....	6
Table 1.3 - Ordering Information .....	7
Table 2.1 – RS232 DTE to DCE connection with straight-through cable .....	9
Table 2.2 – RS232 DTE to DTE connection with null-modem cable .....	9
Table 3.1 – USB "B" Receptacle Pin-Out .....	16
Table 3.2 – DE-9P RS232 Pin-Out.....	16
Table 4.1 - USB Electrical Details.....	17
Table 4.2 - RS232 Electrical Details .....	17
Table 4.3 - Power Output Option.....	17
Table 5.1 - USB2-F-1001 Case Dimensions.....	18
Table 5.2 - USB2-F-1001 Case Dimensions with UniClip.....	19
Table 6.1 - Storage Temperature.....	20
Table 6.2 - Operating Temperature .....	20

**Table 7.1 - Import / Export Information.....22**

## Appendix B - Revision History

Version 1.0	Initial Release – subject to change	2009-02-20
Version 1.1	Added Pin 9 Configuration Utility Details. Changed +5V supply to 250mA	2009-02-25