

# RR5 Series

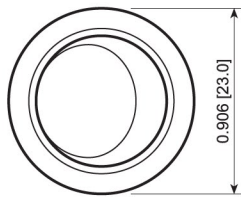

ROCKER



### Suggested Panel Cutout

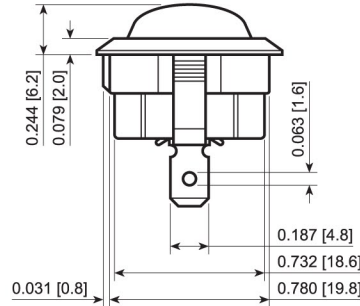
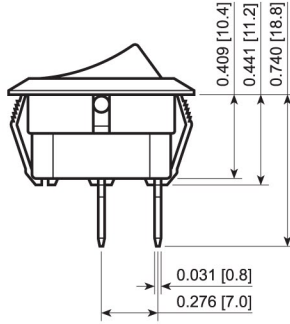
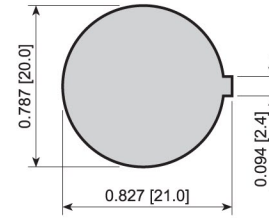

### FEATURES:

- Aesthetically Designed
- High Ratings with UL and ENEC Approvals
- Single Pole With Various Functions
- Short Body for Low Clearance Applications

### SPECIFICATIONS:

RATING: *RATING OPTION D:*

20A 125VAC T65 [UL, cUL]

12A 250VAC T65 [UL, cUL]

10(4)A 250V~ 5E4 T125 [ENEC]

TEMPERATURE: -20°C to 65°C [UL, cUL]

-20°C to 125°C [ENEC]

ELECTRICAL LIFE: 10,000 Cycles

CONTACT RESISTANCE: 35mΩ Max. at 50VAC

INSULATION RESISTANCE: 100MΩ Min. at 500VAC

DIELECTRIC STRENGTH: 1,500VAC for 1 Minute

### MATERIALS:

Body: Polyamide 6/6, UL94 V-2

ACTUATOR: Polyamide 6/6, UL94 V-2

CONTACTS: Silver Alloy

TERMINALS: Silver Plated Copper

### Terminal Options

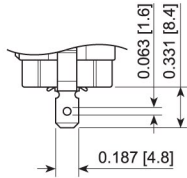

4.8mm Tab

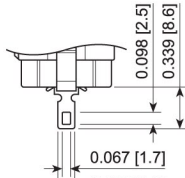

Solder

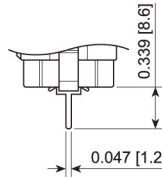

PCB Pin



RR51D1123

Series	Terminal	Function	Rating	Body Color	Actuator Color	Marking Color	Marking Type
RR5	1 - 4.8mm Tab (Small Hole) 3 - PCB Pins 5 - Solder	1 - Off-On 4 - Off-(On)	D - 20A 125VAC	1 - Black 2 - White 4 - Grey 9 - Red	1 - Black 2 - White 4 - Grey 5 - Orange 7 - Blue 8 - Green 9 - Red	0 - None 1 - Black 2 - White 8 - Red	0 - None 1 - I/O Vert. 3 - ON/OFF Vert. 4 - ON/OFF Horiz. R - I/O Horiz.

Custom Colors and Markings Available Upon Request

### EXAMPLE PART NUMBERS:

RR51D1100 1P Off-On  
Black Body/Actuator, No Marking

RR51D1121 1P Off-On  
Black Body/Actuator, I/O Vert.

SPECIFICATIONS SUBJECT TO CHANGE WITHOUT NOTICE



E-SWITCH®

www.e-switch.com

800.867.2717