

### SILICON BRIDGE RECTIFIERS

VOLTAGE RANGE: 50 --- 400 V  
CURRENT: 1.0 A

#### FEATURES

- ◇ Rating to 400 VPRV
- ◇ Surge overload rating to 30 Amperes peak
- ◇ Ideal for printed circuit board
- ◇ Reliable low cost construction utilizing molded
- ◇ Lead solderable per MIL-STD-202 method 208
- ◇ Lead: silver plated copper, solderde plated
- ◇ Plastic material has UL flammability classification 94V-O
- ◇ Polarity symbols molded on body
- ◇ Weight: 1.0 grams

#### DB-S

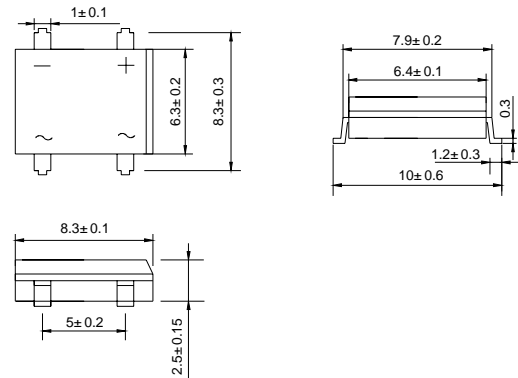

Dimensions in millimeters

#### MAXIMUM RATINGS AND ELECTRICAL CHARACTERISTICS

Ratings at 25°C ambient temperature unless otherwise specified.

Single phase, half wave, 60 Hz, resistive or inductive load. For capacitive load, derate by 20%.

		EDB 101S	EDB 102S	EDB 103S	EDB 104S	EDB 105S	EDB 106S	UNITS
Maximum recurrent peak reverse voltage	$V_{RRM}$	50	100	150	200	300	400	V
Maximum RMS voltage	$V_{RMS}$	35	70	105	140	210	280	V
Maximum DC blocking voltage	$V_{DC}$	50	100	150	200	300	400	V
Maximum average forward Output current @ $T_A=55^\circ C$	$I_{F(AV)}$	1.0						A
Peak forward surge current 8.3ms single half-sine-wave superimposed on rated load	$I_{FSM}$	30.0						A
Maximum instantaneous forward voltage at 1.0 A	$V_F$	1.0						V
Maximum reverse current @ $T_A=25^\circ C$ at rated DC blocking voltage @ $T_A=100^\circ C$	$I_R$	10.0 1.0						$\mu A$ mA
Maximum reverse recovery time (NOTE 1)	$t_{rr}$	50						nS
Typical junction capacitance (NOTE 2)	$C_J$	15				10		pF
Operating junction temperature range	$T_J$	- 55 ---- + 150						°C
Storage temperature range	$T_{STG}$	- 55 ---- + 150						°C

NOTE: 1. Test conditions:  $I_F=0.5A$ ,  $I_R=1.0A$ ,  $I_{RR}=0.25A$ .

2. Measured at 1 MHz and applied reverse voltage of 4.0 volts.

www.galaxyen.com

**FIG.1 – TEST CIRCUIT DIAGRAM AND REVERSE RECOVERY TIME CHARACTERISTIC**

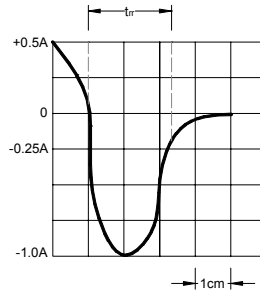
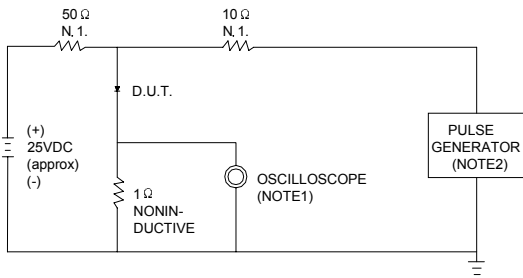

NOTES: 1. RISE TIME = 7ns MAX. INPUT IMPEDANCE = 1MΩ. 22pF  
2. RISE TIME = 10ns MAX. SOURCE IMPEDANCE = 50Ω

SET TIME BASE FOR  
10 ns / cm

**FIG.2 – TYPICAL FORWARD CURRENT DERATING CURVE**

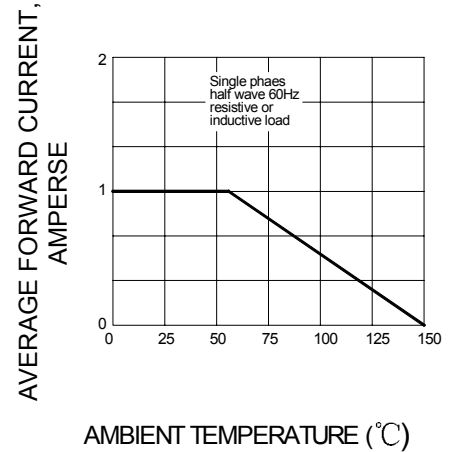

**FIG.3 – TYPICAL REVERSE CHARACTERISTICS**

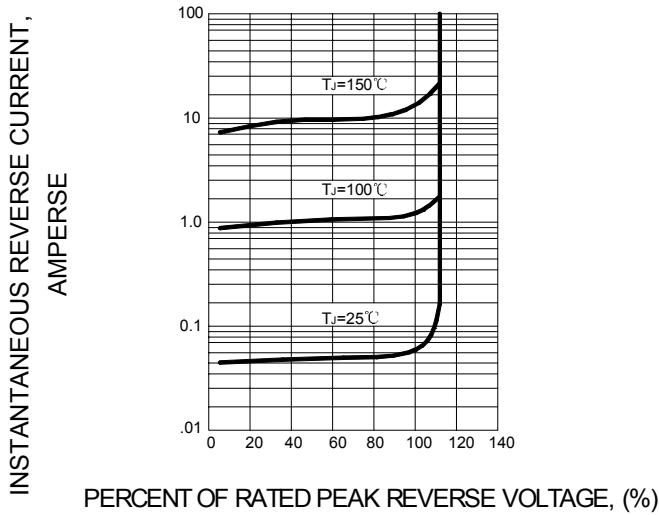

**FIG.4 – TYPICAL INSTANTANEOUS FORWARD CHARACTERISTICS**

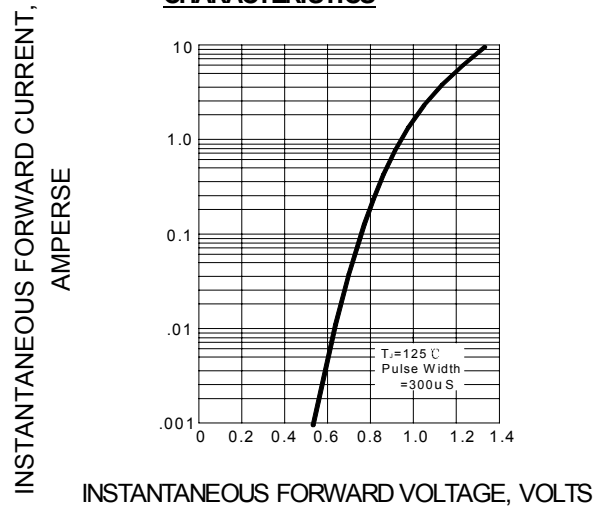

**FIG.5 – MAXIMUM NON-REPETTIVE FORWARD SURGE CURRENT**

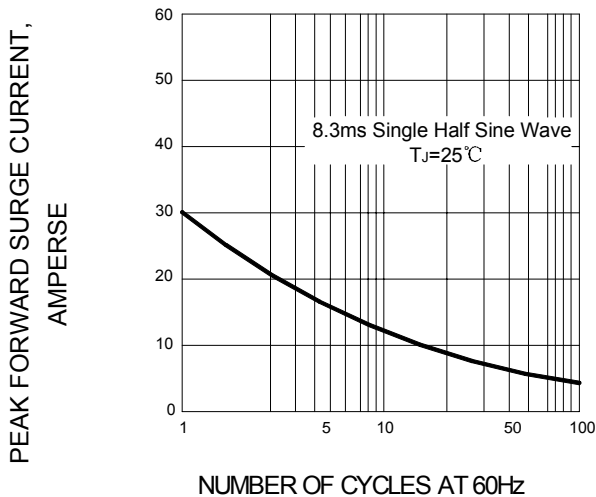

**FIG.6 – TYPICAL JUNCTION CAPACITANCE**

