

SILICON BRIDGE RECTIFIERS

VOLTAGE RANGE: 50 --- 1000 V
CURRENT: 8.0 A

FEATURES

- ◇ Rating to 1000V PRV
- ◇ Surge overload rating to 50 Amperes peak
- ◇ Ideal for printed circuit board
- ◇ Reliable low cost construction utilizing molded plastic technique results in inexpensive product
- ◇ Lead solderable per MIL-STD-202 method 208

KBU

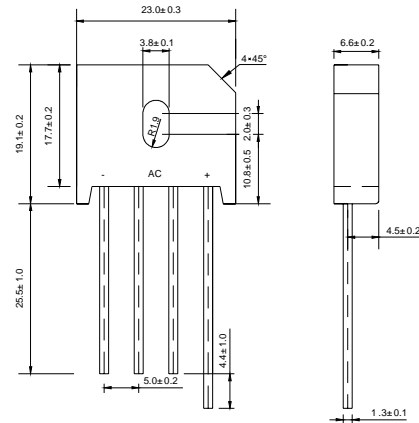

Dimensions in millimeters

MAXIMUM RATINGS AND ELECTRICAL CHARACTERISTICS

Ratings at 25°C ambient temperature unless otherwise specified.

Single phase, half wave, 60 Hz, resistive or inductive load. For capacitive load, derate by 20%.

| | | RS801 | RS802 | RS803 | RS804 | RS805 | RS806 | RS807 | UNITS |
|--|-------------|-----------------|-------|-------|-------|-------|-------|-------|---------------|
| Maximum recurrent peak reverse voltage | V_{RRM} | 50 | 100 | 200 | 400 | 600 | 800 | 1000 | V |
| Maximum RMS voltage | V_{RMS} | 35 | 70 | 140 | 280 | 420 | 560 | 700 | V |
| Maximum DC blocking voltage | V_{DC} | 50 | 100 | 200 | 400 | 600 | 800 | 1000 | V |
| Maximum average forward Output current @ $T_A=25^\circ C$ | $I_{F(AV)}$ | 8.0 | | | | | | | A |
| Peak forward surge current 8.3ms single half-sine-wave superimposed on rated load | I_{FSM} | 200.0 | | | | | | | A |
| Maximum instantaneous forward voltage at 4.0 A | V_F | 1.0 | | | | | | | V |
| Maximum reverse current @ $T_A=25^\circ C$ at rated DC blocking voltage @ $T_A=100^\circ C$ | I_R | 10.0 1.0 | | | | | | | μA mA |
| Operating junction temperature range | T_J | - 55 ---- + 125 | | | | | | | $^\circ C$ |
| Storage temperature range | T_{STG} | - 55 ---- + 150 | | | | | | | $^\circ C$ |

www.galaxycn.com

FIG.1 – TYPICAL FORWARD CURRENT DERATING CURVE

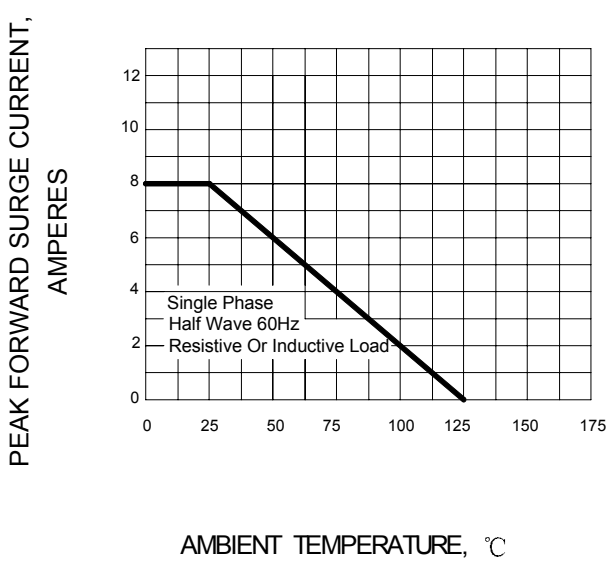

FIG.2 – MAXIMUM FORWARD SURGE CURRENT

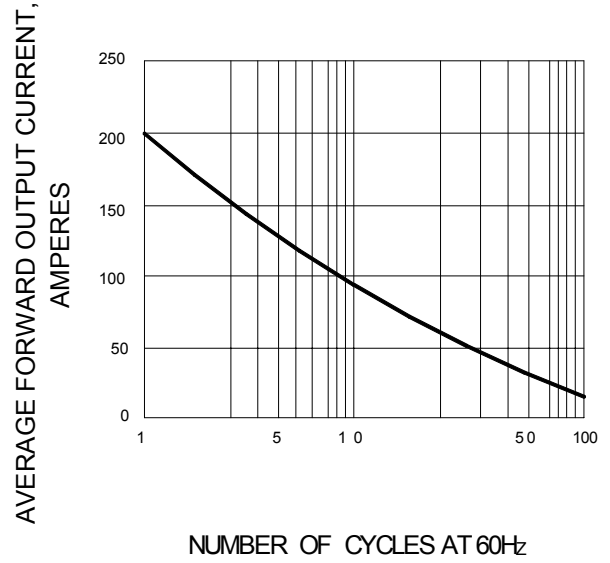

FIG.3 – TYPICAL FORWARD CHARACTERISTIC

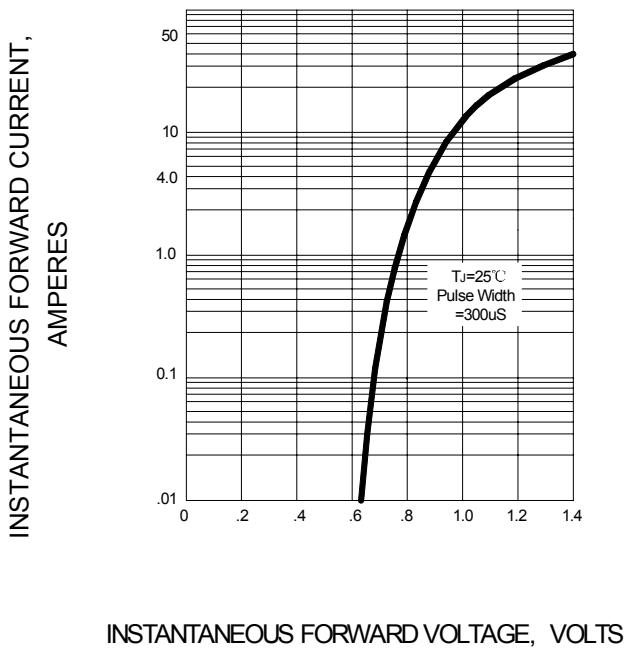

FIG.4 – TYPICAL REVERSE CHARACTERISTIC

