

SILICON BRIDGE RECTIFIERS

VOLTAGE RANGE: 50 --- 1000 V
CURRENT: 8.0A

FEATURES

- ◇ Rating to 1000V PRV
- ◇ Surge overload rating to 250 Amperes peak
- ◇ Ideal for printed circuit board
- ◇ Reliable low cost construction utilizing molded plastic technique results in inexpensive product
- ◇ Lead solderable per MIL-STD-202 method 208

KBU

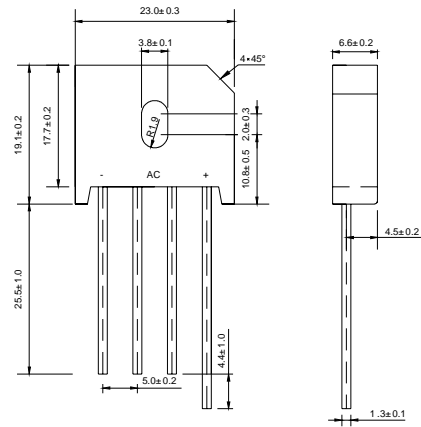

Dimensions in millimeters

MAXIMUM RATINGS AND ELECTRICAL CHARACTERISTICS

Ratings at 25°C ambient temperature unless otherwise specified.

Single phase, half wave, 60 Hz, resistive or inductive load. For capacitive load, derate by 20%.

		KBU 8A	KBU 8B	KBU 8D	KBU 8G	KBU 8J	KBU 8K	KBU 8M	UNITS
Maximum recurrent peak reverse voltage	V_{RRM}	50	100	200	400	600	800	1000	V
Maximum RMS voltage	V_{RMS}	35	70	140	280	420	560	700	V
Maximum DC blocking voltage	V_{DC}	50	100	200	400	600	800	1000	V
Maximum average forward output current @ $T_A=50^\circ\text{C}$	$I_{F(AV)}$	8.0							A
Peak forward surge current 8.3ms single half-sine-wave superimposed on rated load	I_{FSM}	250.0							A
Maximum instantaneous forward voltage @ 4.0 A	V_F	1.0							V
Maximum reverse current @ $T_A=25^\circ\text{C}$ at rated DC blocking voltage @ $T_A=100^\circ\text{C}$	I_R	10.0 1.0							μA mA
Operating junction temperature range	T_J	- 55 ---- + 125							$^\circ\text{C}$
Storage temperature range	T_{STG}	- 55 ---- + 150							$^\circ\text{C}$

www.galaxycn.com

FIG.1 – TYPICAL FORWARD CURRENT DERATING CURVE

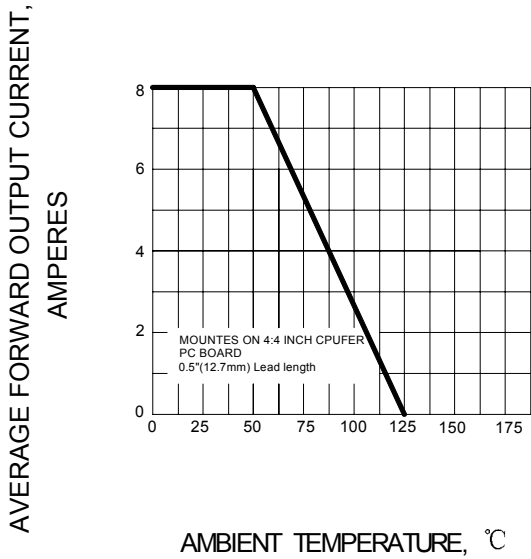

FIG.2 – MAXIMUM FORWARD SURGE CURRENT

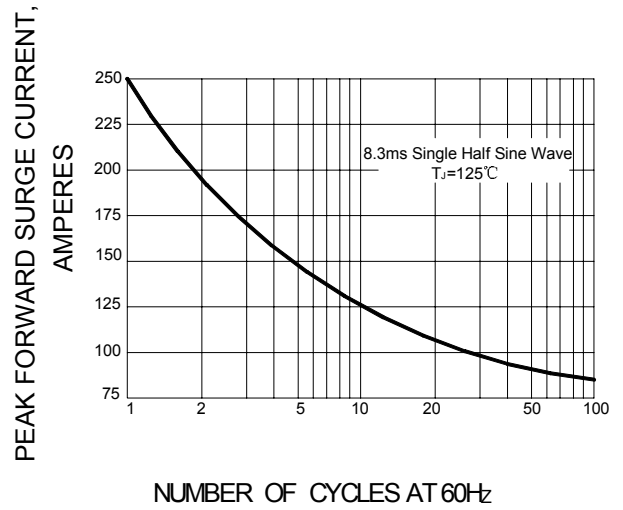

FIG.3 – TYPICAL FORWARD CHARACTERISTIC

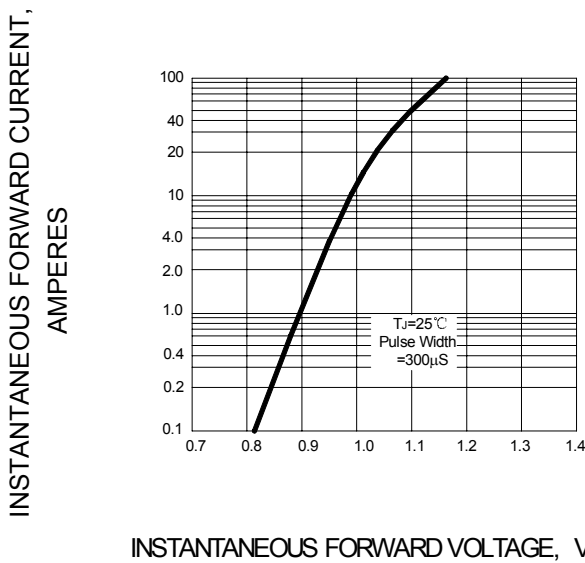

FIG.4 – TYPICAL REVERSE CHARACTERISTIC

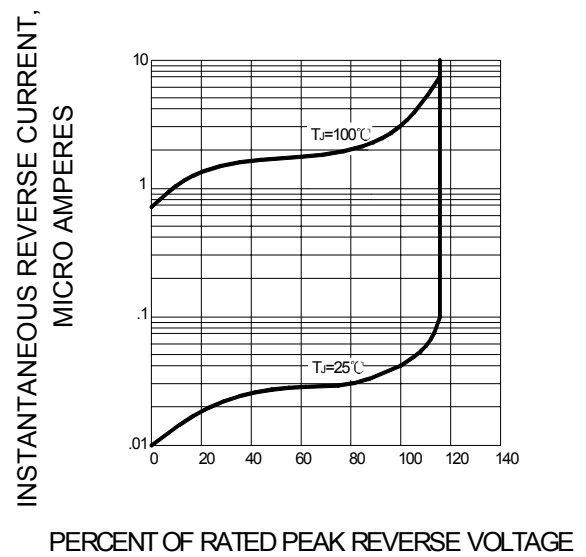

FIG.5 – TYPICAL JUNCTION CAPACITANCE PER ELEMENT

