



MICROCHIP TC4426A/TC4427A/TC4428A

1.5A Dual High-Speed Power MOSFET Drivers

Features:

- High Peak Output Current – 1.5A
- Wide Input Supply Voltage Operating Range:
 - 4.5V to 18V
- High Capacitive Load Drive Capability – 1000 pF in 25 ns (typ.)
- Short Delay Times – 30 ns (typ.)
- Matched Rise, Fall and Delay Times
- Low Supply Current:
 - With Logic '1' Input – 1 mA (typ.)
 - With Logic '0' Input – 100 μ A (typ.)
- Low Output Impedance – 7 Ω (typ.)
- Latch-Up Protected: Will Withstand 0.5A Reverse Current
- Input Will Withstand Negative Inputs Up to 5V
- ESD Protected – 4 kV
- Pin-compatible with TC426/TC427/TC428 and TC4426/TC4427/TC4428
- Space-saving 8-Pin MSOP and 8-Pin 6x5 DFN Packages

General Description:

The TC4426A/TC4427A/TC4428A are improved versions of the earlier TC4426/TC4427/TC4428 family of MOSFET drivers. In addition to matched rise and fall times, the TC4426A/TC4427A/TC4428A devices have matched leading and falling edge propagation delay times.

These devices are highly latch-up resistant under any conditions within their power and voltage ratings. They are not subject to damage when up to 5V of noise spiking (of either polarity) occurs on the ground pin. They can accept, without damage or logic upset, up to 500 mA of reverse current (of either polarity) being forced back into their outputs. All terminals are fully protected against Electrostatic Discharge (ESD) up to 4 kV.

The TC4426A/TC4427A/TC4428A MOSFET drivers can easily charge/discharge 1000 pF gate capacitances in under 30 ns. These devices provide low enough impedances in both the on and off states to ensure the MOSFET's intended state will not be affected, even by large transients.

Applications:

- Switch Mode Power Supplies
- Line Drivers
- Pulse Transformer Drive

Package Types

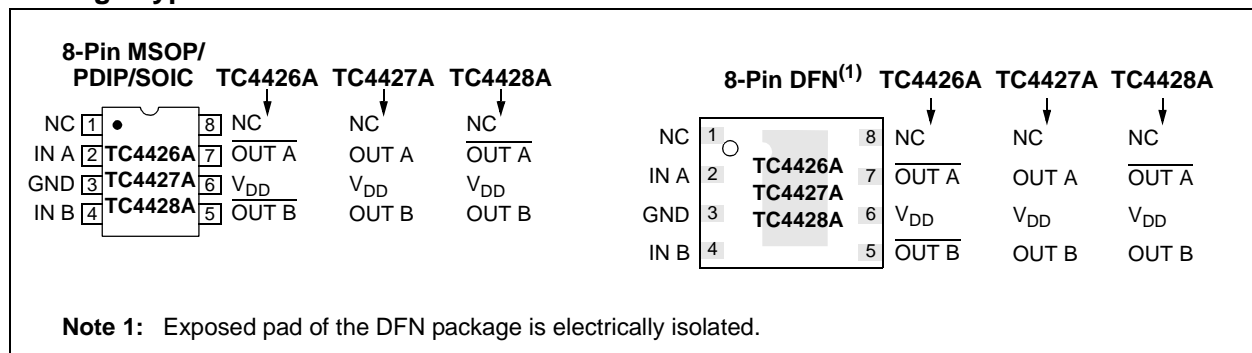

TC4426A/TC4427A/TC4428A

Functional Block Diagram

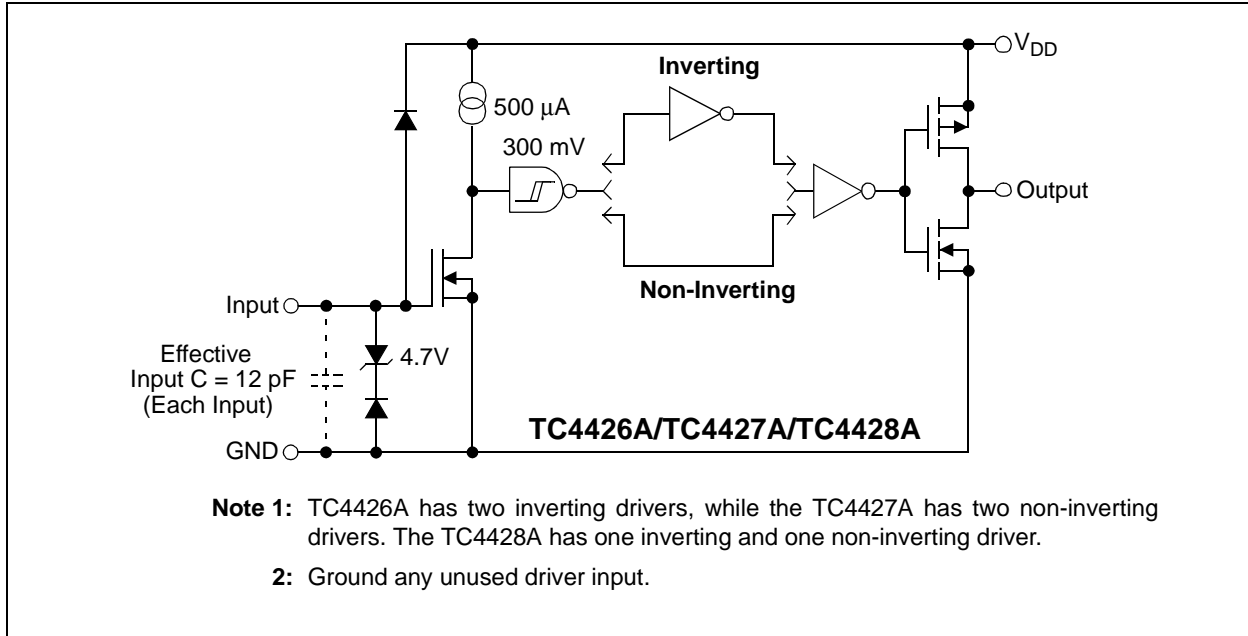

TC4426A/TC4427A/TC4428A

1.0 ELECTRICAL CHARACTERISTICS

Absolute Maximum Ratings†

Supply Voltage	+22V
Input Voltage, IN A or IN B	(V _{DD} + 0.3V) to (GND – 5V)
Package Power Dissipation (T _A ≤ 70°C)	
DFN	Note 2
MSOP	340 mW
PDIP	730 mW
SOIC	470 mW

† **Notice:** Stresses above those listed under “Absolute Maximum Ratings” may cause permanent damage to the device. These are stress ratings only and functional operation of the device at these or any other conditions above those indicated in the operation sections of the specifications is not implied. Exposure to Absolute Maximum Rating conditions for extended periods may affect device reliability.

DC CHARACTERISTICS

Electrical Specifications: Unless otherwise noted, over operating temperature range with 4.5V ≤ V _{DD} ≤ 18V.						
Parameters	Sym	Min	Typ	Max	Units	Conditions
Input						
Logic ‘1’, High Input Voltage	V _{IH}	2.4	—	—	V	
Logic ‘0’, Low Input Voltage	V _{IL}	—	—	0.8	V	
Input Current	I _{IN}	-1.0 -10	—	+1.0 +10	μA	0V ≤ V _{IN} ≤ V _{DD}
Output						
High Output Voltage	V _{OH}	V _{DD} - 0.025	—	—	V	DC Test
Low Output Voltage	V _{OL}	—	—	0.025	V	DC Test
Output Resistance	R _O	—	7 7 8 8	9 10 11 12	Ω	I _{OUT} = 10 mA, V _{DD} = 18V, T _A = +25°C 0°C ≤ T _A ≤ +70°C -40°C ≤ T _A ≤ +85°C -40°C ≤ T _A ≤ +125°C
Peak Output Current	I _{PK}	—	1.5	—	A	V _{DD} = 18V
Latch-Up Protection Withstand Reverse Current	I _{REV}	—	> 0.5	—	A	Duty cycle ≤ 2%, t ≤ 300 μsec V _{DD} = 18V
Switching Time (Note 1)						
Rise Time	t _R	—	25 27 29 30	35 40 40 40	ns	T _A = +25°C 0°C ≤ T _A ≤ +70°C -40°C ≤ T _A ≤ +85°C -40°C ≤ T _A ≤ +125°C, Figure 4-1
Fall Time	t _F	—	25 27 29 30	35 40 40 40	ns	T _A = +25°C 0°C ≤ T _A ≤ +70°C -40°C ≤ T _A ≤ +85°C -40°C ≤ T _A ≤ +125°C, Figure 4-1
Delay Time	t _{D1}	—	30 33 35 38	35 40 45 50	ns	T _A = +25°C 0°C ≤ T _A ≤ +70°C -40°C ≤ T _A ≤ +85°C -40°C ≤ T _A ≤ +125°C, Figure 4-1
Delay Time	t _{D2}	—	30 33 35 38	35 40 45 50	ns	T _A = +25°C 0°C ≤ T _A ≤ +70°C -40°C ≤ T _A ≤ +85°C -40°C ≤ T _A ≤ +125°C, Figure 4-1
Power Supply						
Power Supply Current	I _S	—	1.0 0.1	2.0 0.2	mA	V _{IN} = 3V (Both inputs) V _{IN} = 0V (Both inputs), V _{DD} = 18V

- Note 1:** Switching times ensured by design.
Note 2: Package power dissipation is dependent on the copper pad area on the PCB.

TC4426A/TC4427A/TC4428A

TEMPERATURE CHARACTERISTICS

Electrical Specifications: Unless otherwise noted, all parameters apply with $4.5V \leq V_{DD} \leq 18V$.						
Parameters	Sym	Min	Typ	Max	Units	Conditions
Temperature Ranges						
Specified Temperature Range (C)	T_A	0	—	+70	°C	
Specified Temperature Range (E)	T_A	-40	—	+85	°C	
Specified Temperature Range (V)	T_A	-40	—	+125	°C	
Maximum Junction Temperature	T_J	—	—	+150	°C	
Storage Temperature Range	T_A	-65	—	+150	°C	
Package Thermal Resistances						
Thermal Resistance, 8L-6x5 DFN	θ_{JA}	—	33.2	—	°C/W	
Thermal Resistance, 8L-MSOP	θ_{JA}	—	206	—	°C/W	
Thermal Resistance, 8L-PDIP	θ_{JA}	—	125	—	°C/W	
Thermal Resistance, 8L-SOIC	θ_{JA}	—	155	—	°C/W	

TC4426A/TC4427A/TC4428A

2.0 TYPICAL PERFORMANCE CURVES

Note: The graphs and tables provided following this note are a statistical summary based on a limited number of samples and are provided for informational purposes only. The performance characteristics listed herein are not tested or guaranteed. In some graphs or tables, the data presented may be outside the specified operating range (e.g., outside specified power supply range) and therefore outside the warranted range.

Note: Unless otherwise indicated, over operating temperature range with $4.5V \leq V_{DD} \leq 18V$.

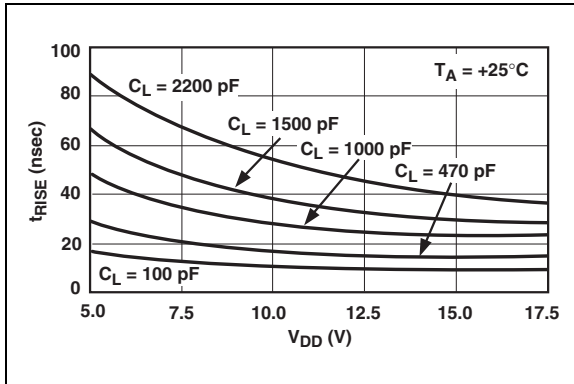

FIGURE 2-1: Rise Time vs. Supply Voltage.

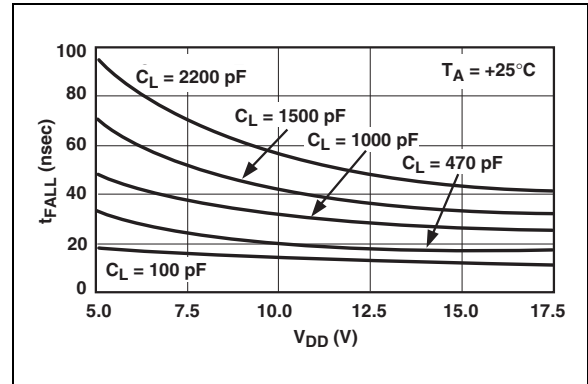

FIGURE 2-4: Fall Time vs. Supply Voltage.

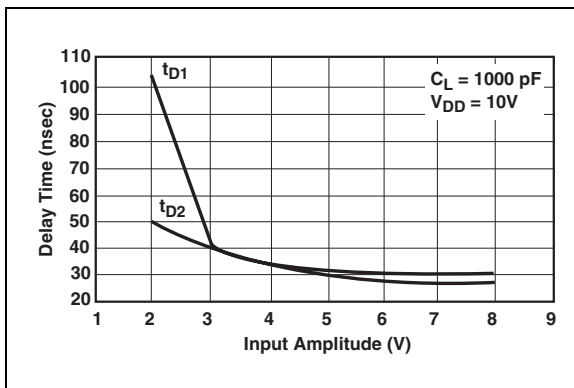

FIGURE 2-2: Delay Time vs. Input Amplitude.

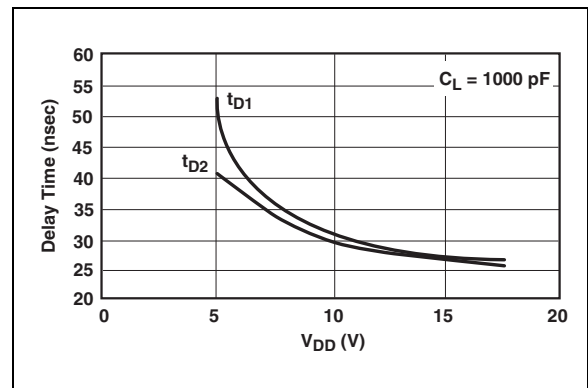

FIGURE 2-5: Propagation Delay Time vs. Supply Voltage.

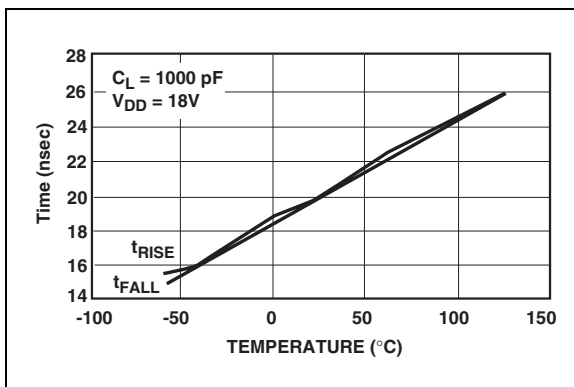

FIGURE 2-3: Rise and Fall Times vs. Temperature.

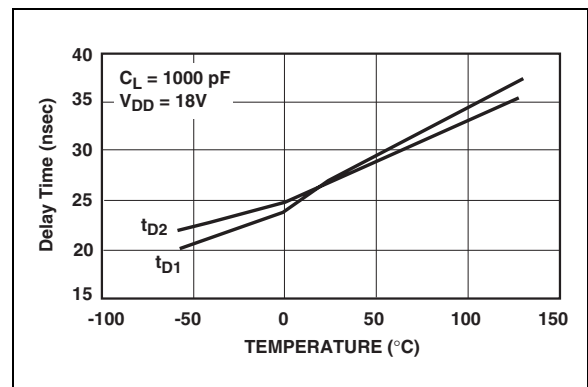

FIGURE 2-6: Propagation Delay Time vs. Temperature.

TC4426A/TC4427A/TC4428A

Note: Unless otherwise indicated, over operating temperature range with $4.5V \leq V_{DD} \leq 18V$.

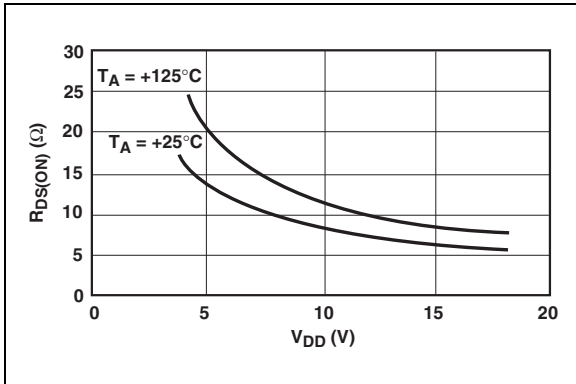

FIGURE 2-7: High-State Output Resistance.

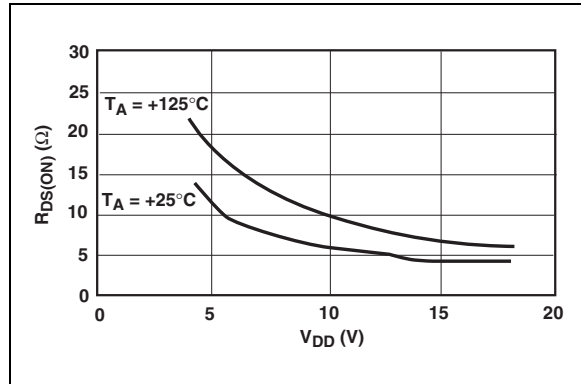

FIGURE 2-10: Low-State Output Resistance.

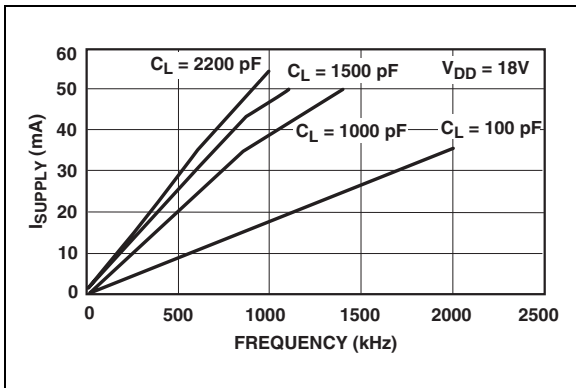

FIGURE 2-8: Supply Current vs. Frequency.

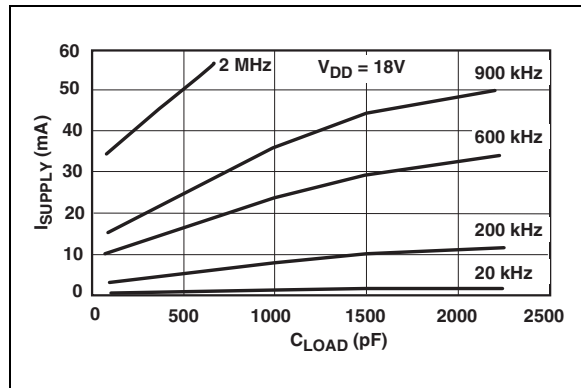

FIGURE 2-11: Supply Current vs. Capacitive Load.

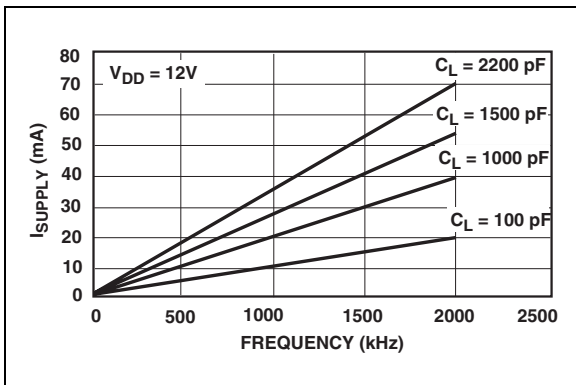

FIGURE 2-9: Supply Current vs. Frequency.

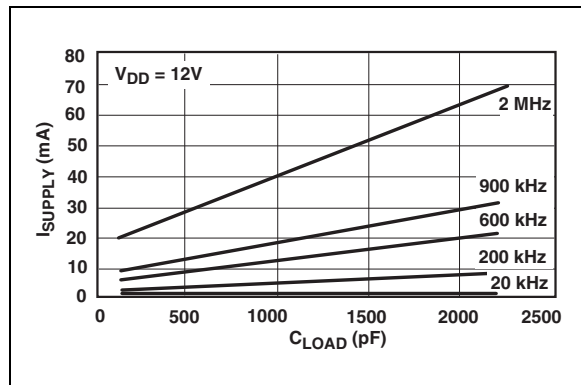

FIGURE 2-12: Supply Current vs. Capacitive Load.

TC4426A/TC4427A/TC4428A

Note: Unless otherwise indicated, over operating temperature range with $4.5V \leq V_{DD} \leq 18V$.

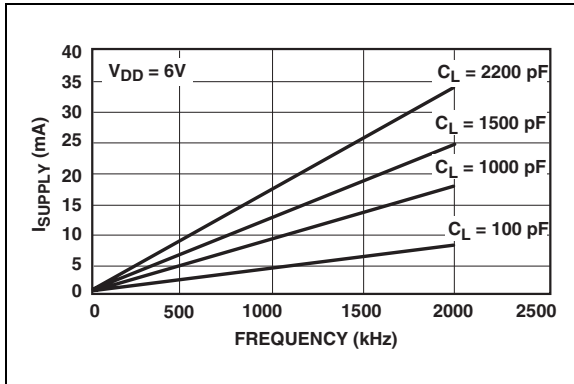

FIGURE 2-13: Supply Current vs. Frequency.

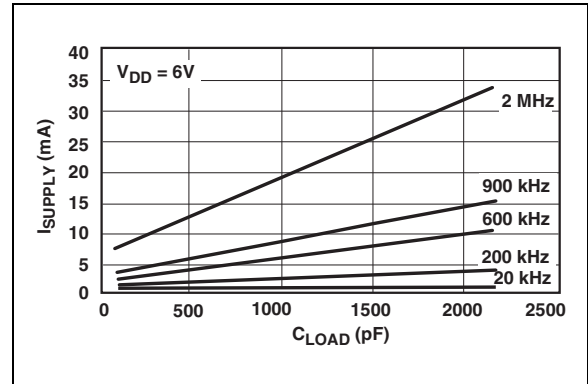

FIGURE 2-15: Supply Current vs. Capacitive Load.

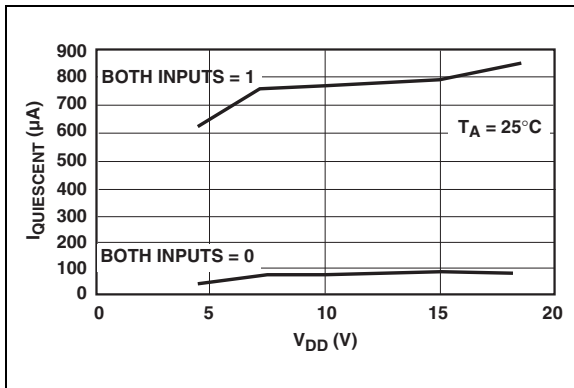

FIGURE 2-14: Quiescent Supply Current vs. Voltage.

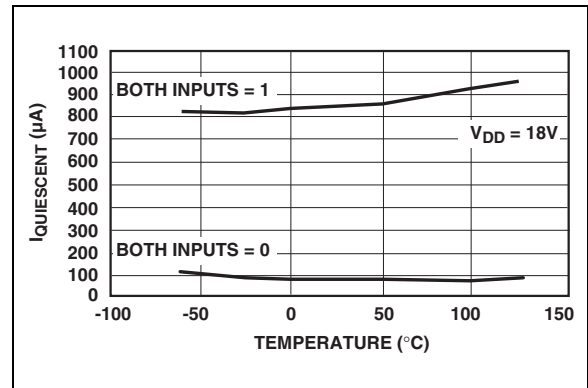

FIGURE 2-16: Quiescent Supply Current vs. Temperature.

TC4426A/TC4427A/TC4428A

3.0 PIN DESCRIPTIONS

The descriptions of the pins are listed in Table 3-1.

TABLE 3-1: PIN FUNCTION TABLE

8-Pin PDIP/ MSOP/SOIC	8-Pin DFN	Symbol	Description
1	1	NC	No connection
2	2	IN A	Input A
3	3	GND	Ground
4	4	IN B	Input B
5	5	OUT B	Output B
6	6	V _{DD}	Supply input
7	7	OUT A	Output A
8	8	NC	No connection
—	PAD	NC	Exposed Metal Pad

Note 1: Duplicate pins must be connected for proper operation.

3.1 Inputs A and B

MOSFET driver inputs A and B are high-impedance, TTL/CMOS compatible inputs. These inputs also have 300 mV of hysteresis between the high and low thresholds that prevents output glitching, even when the rise and fall time of the input signal is very slow.

3.2 Ground (GND)

The ground pin is the return path for both the bias current and the high peak current that discharges the external load capacitance. The ground pin should be tied into a ground plane or have a very short trace to the bias supply source return.

3.3 Output A and B

MOSFET driver outputs A and B are low-impedance, CMOS push-pull style outputs. The pull-down and pull-up devices are of equal strength, making the rise and fall times equivalent.

3.4 Supply Input (V_{DD})

The V_{DD} input is the bias supply for the MOSFET driver and is rated for 4.5V to 18V, with respect to the ground pin. The V_{DD} input should be bypassed with local ceramic capacitors. The value of these capacitors should be chosen based on the capacitive load that is being driven.

3.5 Exposed Metal Pad

The exposed metal pad of the 6x5 DFN package is not internally connected to any potential. Therefore, this pad can be connected to a ground plane or other copper plane on a printed circuit board, to aid in heat removal from the package.

TC4426A/TC4427A/TC4428A

4.0 APPLICATIONS INFORMATION

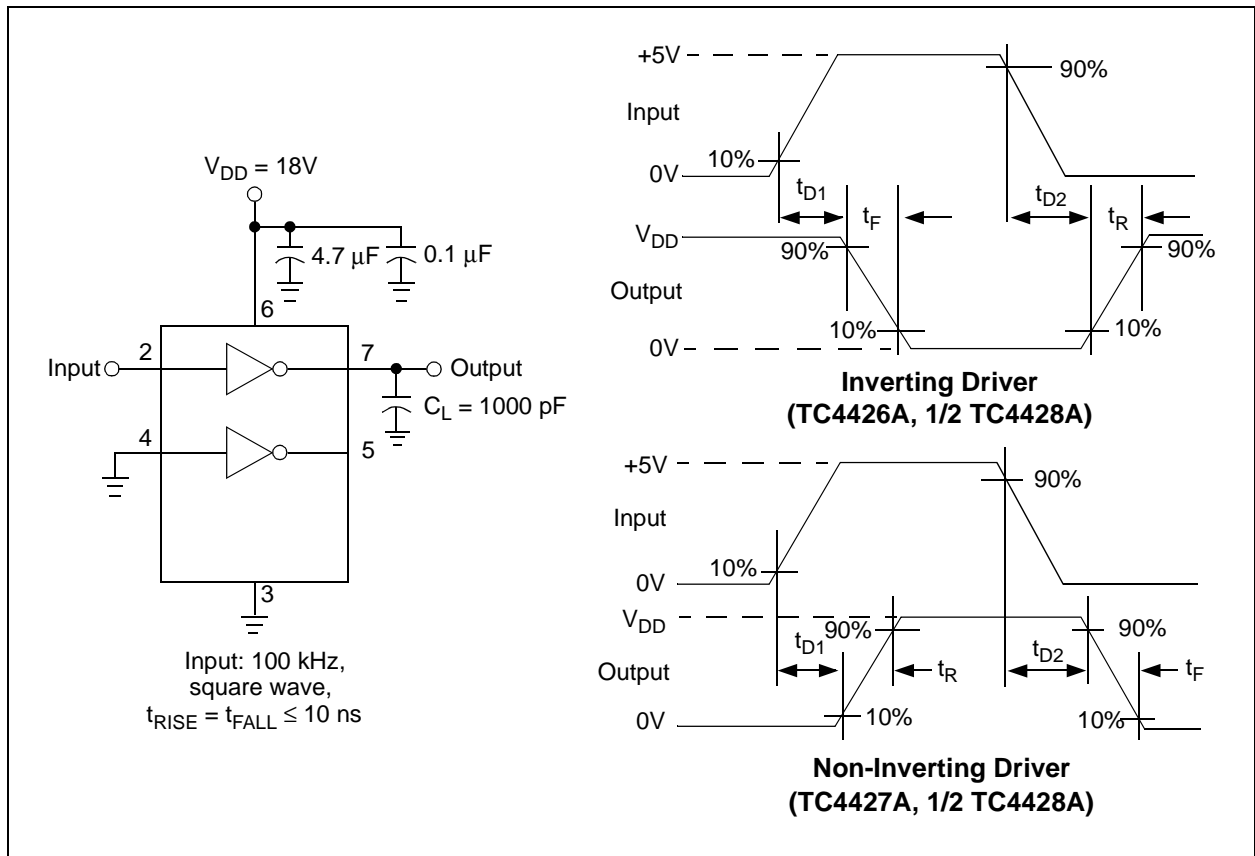

FIGURE 4-1: Switching Time Test Circuit.

TC4426A/TC4427A/TC4428A

5.0 PACKAGING INFORMATION

5.1 Package Marking Information

8-Lead DFN

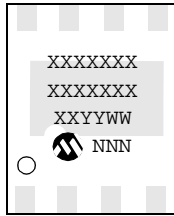

Example:

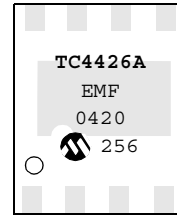

8-Lead MSOP

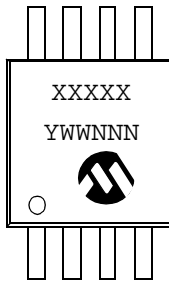

Example:



8-Lead PDIP (300 mil)

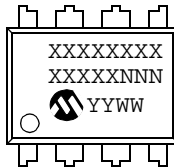

Example:

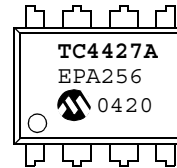

8-Lead SOIC (150 mil)

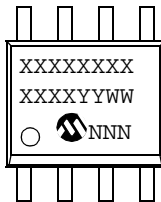

Example:



Legend:	XX...X	Customer specific information*
	YY	Year code (last 2 digits of calendar year)
	WW	Week code (week of January 1 is week '01')
	NNN	Alphanumeric traceability code
Note:	In the event the full Microchip part number cannot be marked on one line, it will be carried over to the next line thus limiting the number of available characters for customer specific information.	

* Standard marking consists of Microchip part number, year code, week code, traceability code (facility code, mask rev#, and assembly code).

TC4426A/TC4427A/TC4428A

8-Lead Plastic Dual Flat No Lead Package (MF) 6x5 mm Body (DFN-S) – Saw Singulated

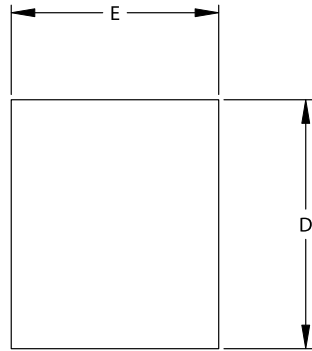

TOP VIEW

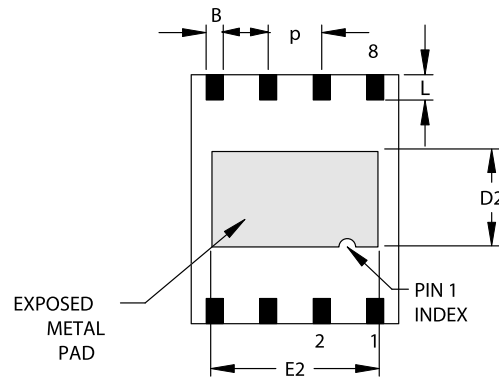

BOTTOM VIEW

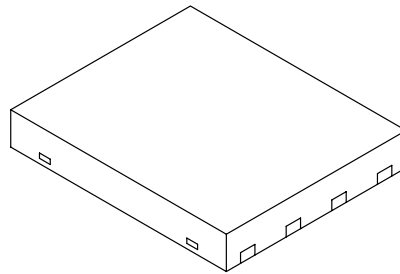
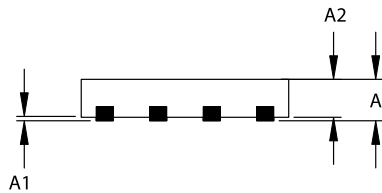

Dimension Limits	Units	INCHES			MILLIMETERS*		
		MIN	NOM	MAX	MIN	NOM	MAX
Number of Pins	n		8			8	
Pitch	P	.050 BSC			1.27 BSC		
Overall Height	A	.033	.035	.037	0.85	0.90	0.95
Package Thickness	A2	.031	.035	.037	0.80	0.89	0.95
Standoff	A1	.000	.0004	.002	0.00	0.01	0.05
Base Thickness	A3	.007	.008	.009	0.17	0.20	0.23
Overall Length	E	.195	.197	.199	4.95	5.00	5.05
Exposed Pad Length	E2	.152	.157	.163	3.85	4.00	4.15
Overall Width	D	.234	.236	.238	5.95	6.00	6.05
Exposed Pad Width	D2	.089	.091	.093	2.25	2.30	2.35
Lead Width	B	.014	.016	.019	0.35	0.40	0.47
Lead Length	L	.024		.026	0.60		0.65

Notes:

JEDEC equivalent: MO-220

Drawing No. C04-122

Revised 11/3/03

TC4426A/TC4427A/TC4428A

8-Lead Plastic Micro Small Outline Package (UA) (MSOP)

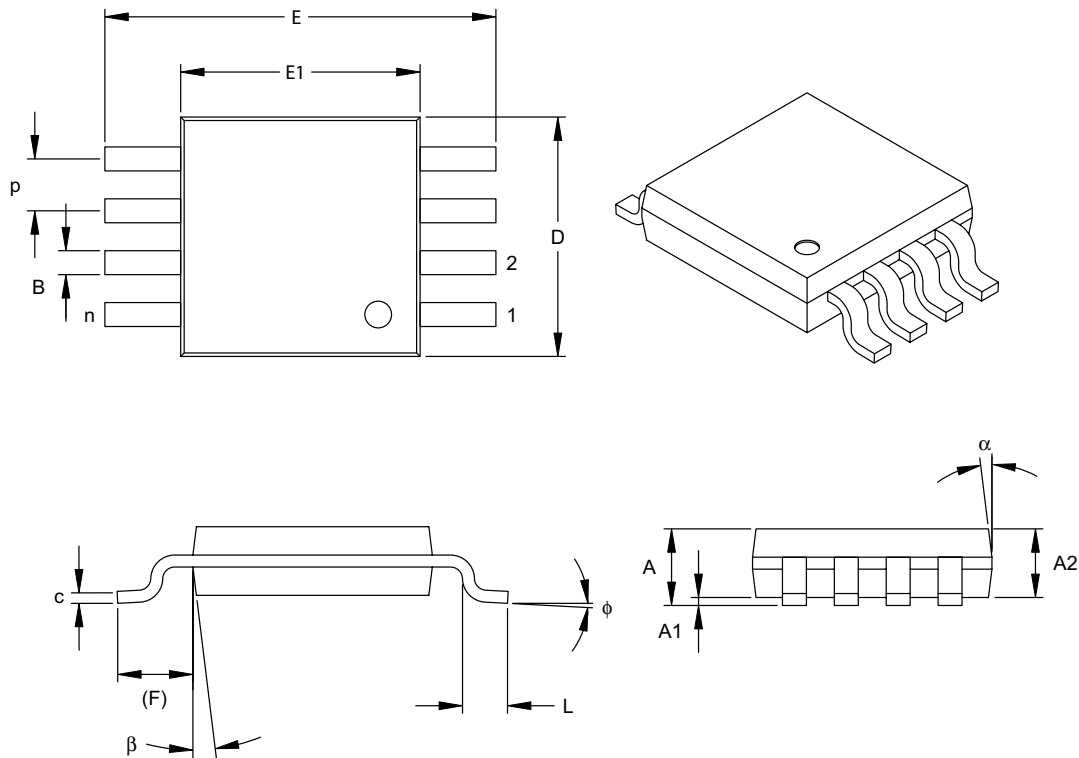

Dimension Limits	Units	INCHES			MILLIMETERS*		
		MIN	NOM	MAX	MIN	NOM	MAX
Number of Pins	n	8			8		
Pitch	p	.026 BSC			0.65 BSC		
Overall Height	A	-	-	.043	-	-	1.10
Molded Package Thickness	A2	.030	.033	.037	0.75	0.85	0.95
Standoff	A1	.000	-	.006	0.00	-	0.15
Overall Width	E	.193 TYP.			4.90 BSC		
Molded Package Width	E1	.118 BSC			3.00 BSC		
Overall Length	D	.118 BSC			3.00 BSC		
Foot Length	L	.016	.024	.031	0.40	0.60	0.80
Footprint (Reference)	F	.037 REF			0.95 REF		
Foot Angle	φ	0°	-	8°	0°	-	8°
Lead Thickness	c	.003	.006	.009	0.08	-	0.23
Lead Width	B	.009	.012	.016	0.22	-	0.40
Mold Draft Angle Top	α	5°	-	15°	5°	-	15°
Mold Draft Angle Bottom	β	5°	-	15°	5°	-	15°

*Controlling Parameter

Notes:

Dimensions D and E1 do not include mold flash or protrusions. Mold flash or protrusions shall not exceed .010" (0.254mm) per side.

JEDEC Equivalent: MO-187

Drawing No. C04-111

TC4426A/TC4427A/TC4428A

8-Lead Plastic Dual In-line (PA) – 300 mil (PDIP)

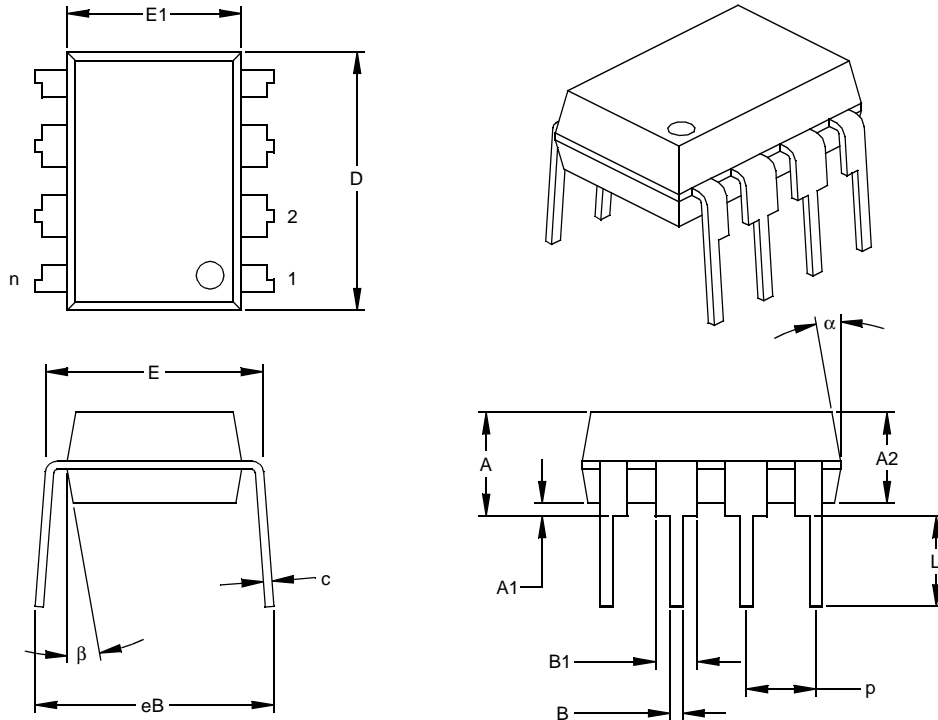

Dimension Limits	Units	INCHES*			MILLIMETERS		
		MIN	NOM	MAX	MIN	NOM	MAX
Number of Pins	n	8			8		
Pitch	p		.100			2.54	
Top to Seating Plane	A	.140	.155	.170	3.56	3.94	4.32
Molded Package Thickness	A2	.115	.130	.145	2.92	3.30	3.68
Base to Seating Plane	A1	.015			0.38		
Shoulder to Shoulder Width	E	.300	.313	.325	7.62	7.94	8.26
Molded Package Width	E1	.240	.250	.260	6.10	6.35	6.60
Overall Length	D	.360	.373	.385	9.14	9.46	9.78
Tip to Seating Plane	L	.125	.130	.135	3.18	3.30	3.43
Lead Thickness	c	.008	.012	.015	0.20	0.29	0.38
Upper Lead Width	B1	.045	.058	.070	1.14	1.46	1.78
Lower Lead Width	B	.014	.018	.022	0.36	0.46	0.56
Overall Row Spacing	§ eB	.310	.370	.430	7.87	9.40	10.92
Mold Draft Angle Top	α	5	10	15	5	10	15
Mold Draft Angle Bottom	β	5	10	15	5	10	15

* Controlling Parameter

§ Significant Characteristic

Notes:

Dimensions D and E1 do not include mold flash or protrusions. Mold flash or protrusions shall not exceed .010" (0.254mm) per side.

JEDEC Equivalent: MS-001

Drawing No. C04-018

TC4426A/TC4427A/TC4428A

8-Lead Plastic Small Outline (OA) – Narrow, 150 mil (SOIC)

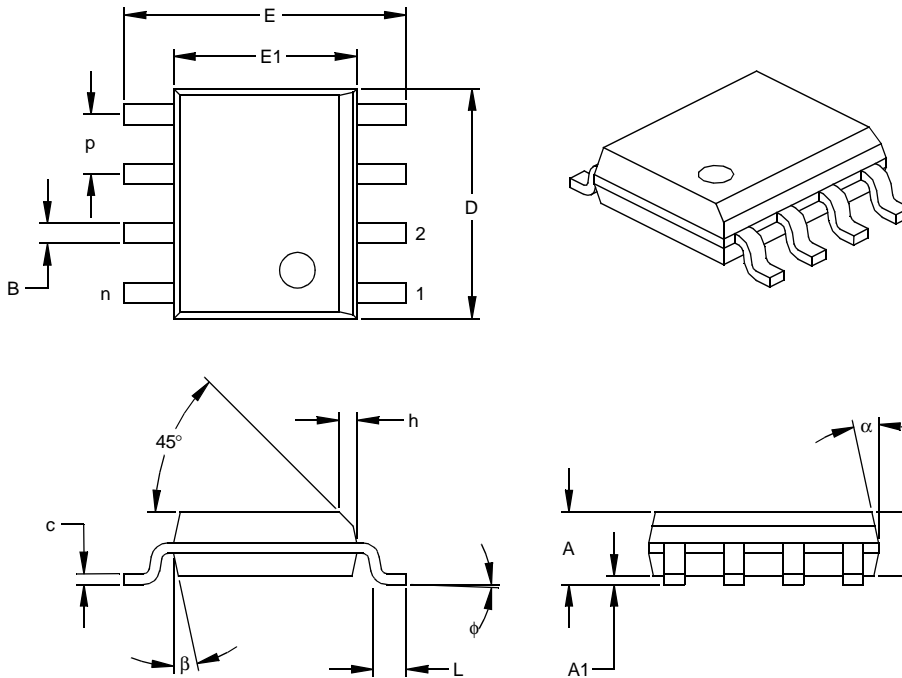

Dimension	Units	INCHES*			MILLIMETERS		
		MIN	NOM	MAX	MIN	NOM	MAX
Number of Pins	n	8			8		
Pitch	p		.050			1.27	
Overall Height	A	.053	.061	.069	1.35	1.55	1.75
Molded Package Thickness	A2	.052	.056	.061	1.32	1.42	1.55
Standoff §	A1	.004	.007	.010	0.10	0.18	0.25
Overall Width	E	.228	.237	.244	5.79	6.02	6.20
Molded Package Width	E1	.146	.154	.157	3.71	3.91	3.99
Overall Length	D	.189	.193	.197	4.80	4.90	5.00
Chamfer Distance	h	.010	.015	.020	0.25	0.38	0.51
Foot Length	L	.019	.025	.030	0.48	0.62	0.76
Foot Angle	φ	0	4	8	0	4	8
Lead Thickness	c	.008	.009	.010	0.20	0.23	0.25
Lead Width	B	.013	.017	.020	0.33	0.42	0.51
Mold Draft Angle Top	α	0	12	15	0	12	15
Mold Draft Angle Bottom	β	0	12	15	0	12	15

* Controlling Parameter

§ Significant Characteristic

Notes:

Dimensions D and E1 do not include mold flash or protrusions. Mold flash or protrusions shall not exceed .010" (0.254mm) per side.

JEDEC Equivalent: MS-012

Drawing No. C04-057

TC4426A/TC4427A/TC4428A

PRODUCT IDENTIFICATION SYSTEM

To order or obtain information, e.g., on pricing or delivery, refer to the factory or the listed sales office.

<u>PART NO.</u>	<u>X</u>	<u>XX</u>	<u>XXX</u>	<u>X</u>
Device	Temperature Range	Package	Tape & Reel	PB Free
Device:	TC4426A: 1.5A Dual MOSFET Driver, Inverting TC4427A: 1.5A Dual MOSFET Driver, Non-Inverting TC4428A: 1.5A Dual MOSFET Driver, Complementary			
Temperature Range:	C = 0°C to +70°C (PDIP & SOIC Only) E = -40°C to +85°C V = -40°C to +125°C			
Package:	MF = Dual, Flat, No-Lead (6X5 mm Body), 8-lead MF713 = Dual, Flat, No-Lead (6X5 mm Body), 8-lead (Tape and Reel) PA = Plastic DIP (300 mil Body), 8-lead OA = Plastic SOIC, (150 mil Body), 8-lead OA713 = Plastic SOIC, (150 mil Body), 8-lead (Tape and Reel) UA = Plastic Micro Small Outline (MSOP), 8-lead UA713 = Plastic Micro Small Outline (MSOP), 8-lead (Tape and Reel)			
Examples:				
a) TC4426ACOA: 1.5A Dual Inverting MOSFET driver, 0°C to +70°C, 8LD SOIC package.				
b) TC4426AEOA: 1.5A Dual Inverting MOSFET driver, -40°C to +85°C, 8LD SOIC package.				
c) TC4426AEMF: 1.5A Dual Inverting MOSFET driver, -40°C to +85°C, 8LD DFN package.				
a) TC4427ACPA: 1.5A Dual Non-Inverting MOSFET driver, 0°C to +70°C, 8LD PDIP package.				
b) TC4427AEPA: 1.5A Dual Non-Inverting MOSFET driver, -40°C to +85°C, 8LD PDIP package.				
c) TC4427AVMF713: 1.5A Dual Non-Inverting MOSFET driver, -40°C to +125°C, 8LD DFN package, Tape and Reel.				
a) TC4428AEPA: 1.5A Dual Complementary MOSFET driver, -40°C to +85°C, 8LD PDIP package.				
b) TC4428ACOA713: 1.5A Dual Complementary MOSFET driver, 0°C to +70°C, 8LD SOIC package, Tape and Reel.				
c) TC4428AVMF: 1.5A Dual Complementary MOSFET driver, -40°C to +125°C, 8LD DFN package.				

Sales and Support

Data Sheets

Products supported by a preliminary Data Sheet may have an errata sheet describing minor operational differences and recommended workarounds. To determine if an errata sheet exists for a particular device, please contact one of the following:

1. Your local Microchip sales office
2. The Microchip Corporate Literature Center U.S. FAX: (480) 792-7277
3. The Microchip Worldwide Site (www.microchip.com)

Please specify which device, revision of silicon and Data Sheet (include Literature #) you are using.

Customer Notification System

Register on our web site (www.microchip.com/cn) to receive the most current information on our products.

TC4426A/TC4427A/TC4428A

NOTES:

Note the following details of the code protection feature on Microchip devices:

- Microchip products meet the specification contained in their particular Microchip Data Sheet.
- Microchip believes that its family of products is one of the most secure families of its kind on the market today, when used in the intended manner and under normal conditions.
- There are dishonest and possibly illegal methods used to breach the code protection feature. All of these methods, to our knowledge, require using the Microchip products in a manner outside the operating specifications contained in Microchip's Data Sheets. Most likely, the person doing so is engaged in theft of intellectual property.
- Microchip is willing to work with the customer who is concerned about the integrity of their code.
- Neither Microchip nor any other semiconductor manufacturer can guarantee the security of their code. Code protection does not mean that we are guaranteeing the product as "unbreakable."

Code protection is constantly evolving. We at Microchip are committed to continuously improving the code protection features of our products. Attempts to break Microchip's code protection feature may be a violation of the Digital Millennium Copyright Act. If such acts allow unauthorized access to your software or other copyrighted work, you may have a right to sue for relief under that Act.

Information contained in this publication regarding device applications and the like is provided only for your convenience and may be superseded by updates. It is your responsibility to ensure that your application meets with your specifications. MICROCHIP MAKES NO REPRESENTATIONS OR WARRANTIES OF ANY KIND WHETHER EXPRESS OR IMPLIED, WRITTEN OR ORAL, STATUTORY OR OTHERWISE, RELATED TO THE INFORMATION, INCLUDING BUT NOT LIMITED TO ITS CONDITION, QUALITY, PERFORMANCE, MERCHANTABILITY OR FITNESS FOR PURPOSE. Microchip disclaims all liability arising from this information and its use. Use of Microchip's products as critical components in life support systems is not authorized except with express written approval by Microchip. No licenses are conveyed, implicitly or otherwise, under any Microchip intellectual property rights.

Trademarks

The Microchip name and logo, the Microchip logo, Accuron, dsPIC, KEELoQ, microID, MPLAB, PIC, PICmicro, PICSTART, PRO MATE, PowerSmart, rPIC, and SmartShunt are registered trademarks of Microchip Technology Incorporated in the U.S.A. and other countries.

AmpLab, FilterLab, Migratable Memory, MXDEV, MXLAB, PICMASTER, SEEVAL, SmartSensor and The Embedded Control Solutions Company are registered trademarks of Microchip Technology Incorporated in the U.S.A.

Analog-for-the-Digital Age, Application Maestro, dsPICDEM, dsPICDEM.net, dsPICworks, ECAN, ECONOMONITOR, FanSense, FlexROM, fuzzyLAB, In-Circuit Serial Programming, ICSP, ICEPIC, Linear Active Thermistor, MPASM, MPLIB, MPLINK, MPSIM, PICkit, PICDEM, PICDEM.net, PICLAB, PICtail, PowerCal, PowerInfo, PowerMate, PowerTool, Real ICE, rLAB, rPICDEM, Select Mode, Smart Serial, SmartTel, Total Endurance, UNI/O, WiperLock and Zena are trademarks of Microchip Technology Incorporated in the U.S.A. and other countries.

SQTP is a service mark of Microchip Technology Incorporated in the U.S.A.

All other trademarks mentioned herein are property of their respective companies.

© 2006, Microchip Technology Incorporated, Printed in the U.S.A., All Rights Reserved.

 Printed on recycled paper.

**QUALITY MANAGEMENT SYSTEM
CERTIFIED BY DNV
== ISO/TS 16949:2002 ==**

Microchip received ISO/TS-16949:2002 quality system certification for its worldwide headquarters, design and wafer fabrication facilities in Chandler and Tempe, Arizona and Mountain View, California in October 2003. The Company's quality system processes and procedures are for its PICmicro® 8-bit MCUs, KEELoQ® code hopping devices, Serial EEPROMs, microperipherals, nonvolatile memory and analog products. In addition, Microchip's quality system for the design and manufacture of development systems is ISO 9001:2000 certified.



WORLDWIDE SALES AND SERVICE

AMERICAS

Corporate Office

2355 West Chandler Blvd.
Chandler, AZ 85224-6199
Tel: 480-792-7200
Fax: 480-792-7277
Technical Support:
<http://support.microchip.com>
Web Address:
www.microchip.com

Atlanta

Alpharetta, GA
Tel: 770-640-0034
Fax: 770-640-0307

Boston

Westborough, MA
Tel: 774-760-0087
Fax: 774-760-0088

Chicago

Itasca, IL
Tel: 630-285-0071
Fax: 630-285-0075

Dallas

Addison, TX
Tel: 972-818-7423
Fax: 972-818-2924

Detroit

Farmington Hills, MI
Tel: 248-538-2250
Fax: 248-538-2260

Kokomo

Kokomo, IN
Tel: 765-864-8360
Fax: 765-864-8387

Los Angeles

Mission Viejo, CA
Tel: 949-462-9523
Fax: 949-462-9608

San Jose

Mountain View, CA
Tel: 650-215-1444
Fax: 650-961-0286

Toronto

Mississauga, Ontario,
Canada
Tel: 905-673-0699
Fax: 905-673-6509

ASIA/PACIFIC

Australia - Sydney

Tel: 61-2-9868-6733
Fax: 61-2-9868-6755

China - Beijing

Tel: 86-10-8528-2100
Fax: 86-10-8528-2104

China - Chengdu

Tel: 86-28-8676-6200
Fax: 86-28-8676-6599

China - Fuzhou

Tel: 86-591-8750-3506
Fax: 86-591-8750-3521

China - Hong Kong SAR

Tel: 852-2401-1200
Fax: 852-2401-3431

China - Qingdao

Tel: 86-532-8502-7355
Fax: 86-532-8502-7205

China - Shanghai

Tel: 86-21-5407-5533
Fax: 86-21-5407-5066

China - Shenyang

Tel: 86-24-2334-2829
Fax: 86-24-2334-2393

China - Shenzhen

Tel: 86-755-8203-2660
Fax: 86-755-8203-1760

China - Shunde

Tel: 86-757-2839-5507
Fax: 86-757-2839-5571

China - Wuhan

Tel: 86-27-5980-5300
Fax: 86-27-5980-5118

China - Xian

Tel: 86-29-8833-7250
Fax: 86-29-8833-7256

ASIA/PACIFIC

India - Bangalore

Tel: 91-80-2229-0061
Fax: 91-80-2229-0062

India - New Delhi

Tel: 91-11-5160-8631
Fax: 91-11-5160-8632

India - Pune

Tel: 91-20-2566-1512
Fax: 91-20-2566-1513

Japan - Yokohama

Tel: 81-45-471-6166
Fax: 81-45-471-6122

Korea - Gumi

Tel: 82-54-473-4301
Fax: 82-54-473-4302

Korea - Seoul

Tel: 82-2-554-7200
Fax: 82-2-558-5932 or
82-2-558-5934

Malaysia - Penang

Tel: 60-4-646-8870
Fax: 60-4-646-5086

Philippines - Manila

Tel: 63-2-634-9065
Fax: 63-2-634-9069

Singapore

Tel: 65-6334-8870
Fax: 65-6334-8850

Taiwan - Hsin Chu

Tel: 886-3-572-9526
Fax: 886-3-572-6459

Taiwan - Kaohsiung

Tel: 886-7-536-4818
Fax: 886-7-536-4803

Taiwan - Taipei

Tel: 886-2-2500-6610
Fax: 886-2-2508-0102

Thailand - Bangkok

Tel: 66-2-694-1351
Fax: 66-2-694-1350

EUROPE

Austria - Wels

Tel: 43-7242-2244-399
Fax: 43-7242-2244-393

Denmark - Copenhagen

Tel: 45-4450-2828
Fax: 45-4485-2829

France - Paris

Tel: 33-1-69-53-63-20
Fax: 33-1-69-30-90-79

Germany - Munich

Tel: 49-89-627-144-0
Fax: 49-89-627-144-44

Italy - Milan

Tel: 39-0331-742611
Fax: 39-0331-466781

Netherlands - Drunen

Tel: 31-416-690399
Fax: 31-416-690340

Spain - Madrid

Tel: 34-91-708-08-90
Fax: 34-91-708-08-91

UK - Wokingham

Tel: 44-118-921-5869
Fax: 44-118-921-5820