

IRF6618/IRF6618TR1

HEXFET® Power MOSFET

- RoHS compliant containing no lead or bromide
- Application Specific MOSFETs
- Ideal for CPU Core DC-DC Converters
- Low Conduction Losses
- Low Switching Losses
- Low Profile (<0.7 mm)
- Dual Sided Cooling Compatible
- Compatible with existing Surface Mount Techniques

V_{DS}	$R_{DS(on)}$ max	Q_g
30V	2.2m Ω @ $V_{GS} = 10V$	43 nC
	3.4m Ω @ $V_{GS} = 4.5V$	

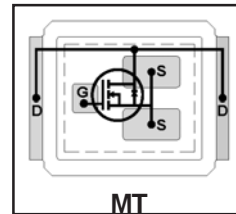

Applicable DirectFET Package/Layout Pad (see p.8,9 for details)

SQ	SX	ST		MQ	MX	MT				
----	----	----	--	----	----	-----------	--	--	--	--

Description

The IRF6618 combines the latest HEXFET® Power MOSFET Silicon technology with the advanced DirectFET™ packaging to achieve the lowest on-state resistance in a package that has the footprint of an SO-8 and only 0.7 mm profile. The DirectFET package is compatible with existing layout geometries used in power applications, PCB assembly equipment and vapor phase, infra-red or convection soldering techniques, when application note AN-1035 is followed regarding the manufacturing methods and processes. The DirectFET package allows dual sided cooling to maximize thermal transfer in power systems, IMPROVING previous best thermal resistance by 80%.

The IRF6618 balances both low resistance and low charge along with ultra low package inductance to reduce both conduction and switching losses. The reduced total losses make this product ideal for high efficiency DC-DC converters that power the latest generation of processors operating at higher frequencies. The IRF6618 has been optimized for parameters that are critical in synchronous buck converters including $R_{ds(on)}$, gate charge and C_{dv}/dt -induced turn on immunity. The IRF6618 offers particularly low $R_{ds(on)}$ and high C_{dv}/dt immunity for synchronous FET applications.

Absolute Maximum Ratings

	Parameter	Max.	Units
V_{DS}	Drain-to-Source Voltage	30	V
V_{GS}	Gate-to-Source Voltage	± 20	
$I_D @ T_C = 25^\circ C$	Continuous Drain Current, $V_{GS} @ 10V$	170	A
$I_D @ T_A = 25^\circ C$	Continuous Drain Current, $V_{GS} @ 10V$	30	
$I_D @ T_A = 70^\circ C$	Continuous Drain Current, $V_{GS} @ 10V$	24	
I_{DM}	Pulsed Drain Current ①	240	
$P_D @ T_A = 25^\circ C$	Power Dissipation ②	2.8	W
$P_D @ T_A = 70^\circ C$	Power Dissipation ②	1.8	
$P_D @ T_C = 25^\circ C$	Power Dissipation	89	
	Linear Derating Factor	0.022	W/°C
T_J	Operating Junction and	-40 to + 150	°C
T_{STG}	Storage Temperature Range		

Avalanche Characteristics

	Parameter	Typ.	Max.	Units
E_{AS}	Single Pulse Avalanche Energy ②	—	210	mJ
I_{AR}	Avalanche Current ①	—	24	A

Thermal Resistance

	Parameter	Typ.	Max.	Units
$R_{\theta JA}$	Junction-to-Ambient ④⑤	—	45	°C/W
$R_{\theta JA}$	Junction-to-Ambient ⑤	12.5	—	
$R_{\theta JA}$	Junction-to-Ambient ⑥	20	—	
$R_{\theta JC}$	Junction-to-Case ⑦	—	1.4	
$R_{\theta J-PCB}$	Junction-to-PCB Mounted	1.0	—	

Notes ① through ⑧ are on page 9

www.irf.com

Static @ T_J = 25°C (unless otherwise specified)

	Parameter	Min.	Typ.	Max.	Units	Conditions
BV _{DSS}	Drain-to-Source Breakdown Voltage	30	—	—	V	V _{GS} = 0V, I _D = 250μA
ΔBV _{DSS} /ΔT _J	Breakdown Voltage Temp. Coefficient	—	23	—	mV/°C	Reference to 25°C, I _D = 1mA
R _{DS(on)}	Static Drain-to-Source On-Resistance	—	1.7	2.2	mΩ	V _{GS} = 10V, I _D = 30A ③
		—	—	3.4		V _{GS} = 4.5V, I _D = 24A ③
V _{GS(th)}	Gate Threshold Voltage	1.35	1.64	2.35	V	V _{DS} = V _{GS} , I _D = 250μA
ΔV _{GS(th)} /ΔT _J	Gate Threshold Voltage Coefficient	—	-5.7	—	mV/°C	
I _{DSS}	Drain-to-Source Leakage Current	—	—	5.0	μA	V _{DS} = 30V, V _{GS} = 0V
		—	—	1.0		V _{DS} = 24V, V _{GS} = 0V
		—	—	150		V _{DS} = 24V, V _{GS} = 0V, T _J = 150°C
I _{GSS}	Gate-to-Source Forward Leakage	—	—	100	nA	V _{GS} = 20V
	Gate-to-Source Reverse Leakage	—	—	-100		V _{GS} = -20V
g _{fs}	Forward Transconductance	100	—	—	S	V _{DS} = 15V, I _D = 24A
Q _g	Total Gate Charge	—	43	65	nC	V _{DS} = 15V V _{GS} = 4.5V I _D = 24A See Fig. 16
Q _{gs1}	Pre-V _{th} Gate-to-Source Charge	—	12	—		
Q _{gs2}	Post-V _{th} Gate-to-Source Charge	—	4.0	—		
Q _{gd}	Gate-to-Drain Charge	—	15	23		
Q _{godr}	Gate Charge Overdrive	—	12	—		
Q _{sw}	Switch Charge (Q _{gs2} + Q _{gd})	—	19	—		
Q _{oss}	Output Charge	—	28	—	nC	V _{DS} = 15V, V _{GS} = 0V
R _G	Gate Resistance	—	1.0	2.2	Ω	
t _{d(on)}	Turn-On Delay Time	—	21	—	ns	V _{DD} = 15V, V _{GS} = 4.5V ③ I _D = 24A Clamped Inductive Load
t _r	Rise Time	—	71	—		
t _{d(off)}	Turn-Off Delay Time	—	27	—		
t _f	Fall Time	—	8.1	—		
C _{iss}	Input Capacitance	—	5640	—	pF	V _{GS} = 0V V _{DS} = 15V f = 1.0MHz
C _{oss}	Output Capacitance	—	1260	—		
C _{rss}	Reverse Transfer Capacitance	—	570	—		

Diode Characteristics

	Parameter	Min.	Typ.	Max.	Units	Conditions
I _S	Continuous Source Current (Body Diode)	—	—	89	A	MOSFET symbol showing the integral reverse p-n junction diode.
I _{SM}	Pulsed Source Current (Body Diode) ①	—	—	240		
V _{SD}	Diode Forward Voltage	—	0.78	1.2	V	T _J = 25°C, I _S = 24A, V _{GS} = 0V ③
t _{rr}	Reverse Recovery Time	—	43	65	ns	T _J = 25°C, I _F = 24A
Q _{rr}	Reverse Recovery Charge	—	46	69	nC	di/dt = 100A/μs ③

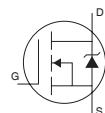

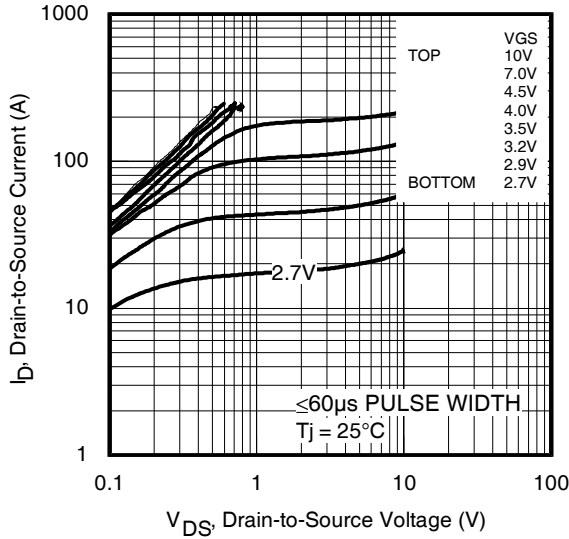

Fig 1. Typical Output Characteristics

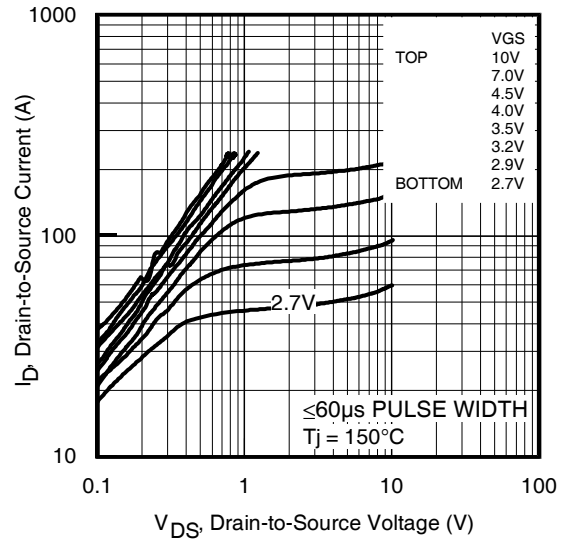

Fig 2. Typical Output Characteristics

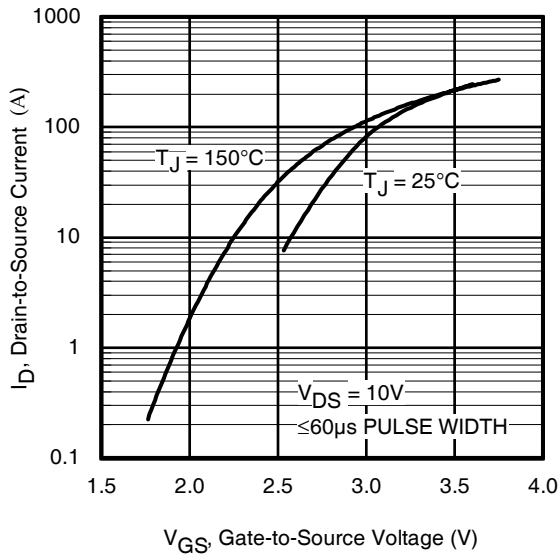

Fig 3. Typical Transfer Characteristics

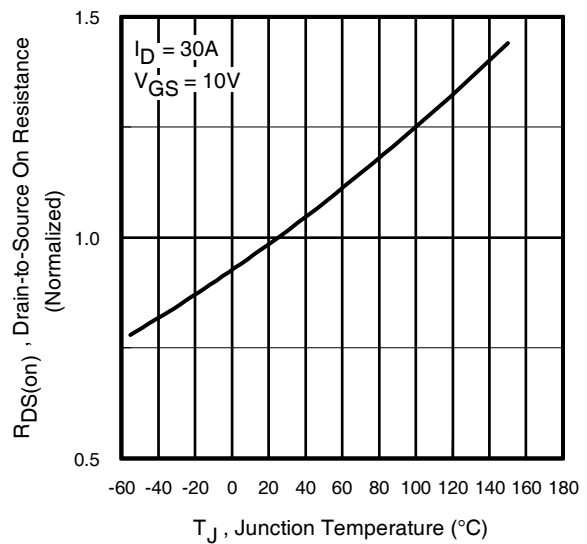

Fig 4. Normalized On-Resistance vs. Temperature

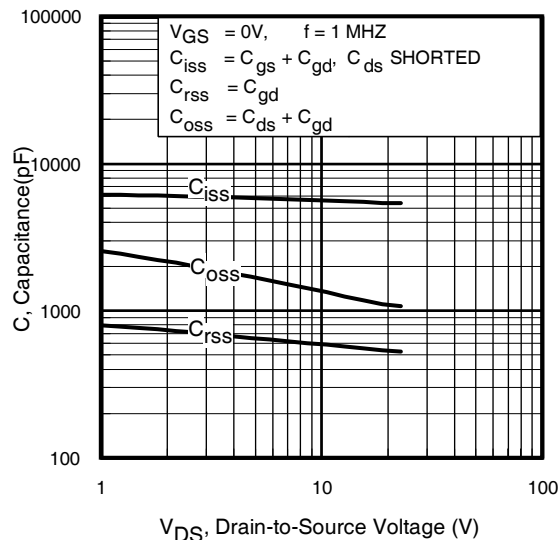

Fig 5. Typical Capacitance vs. Drain-to-Source Voltage

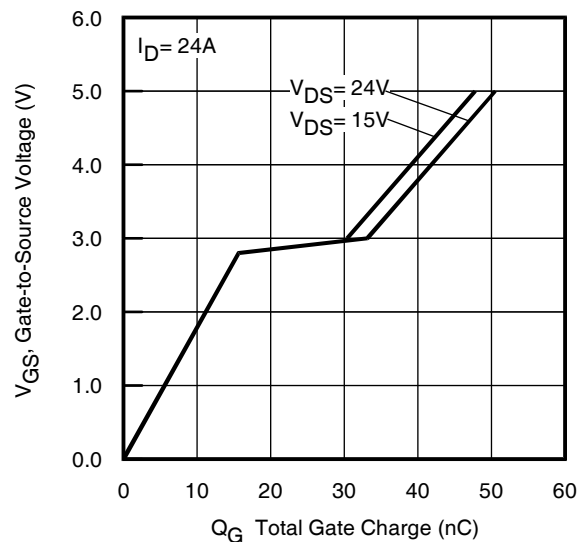

Fig 6. Typical Gate Charge vs. Gate-to-Source Voltage

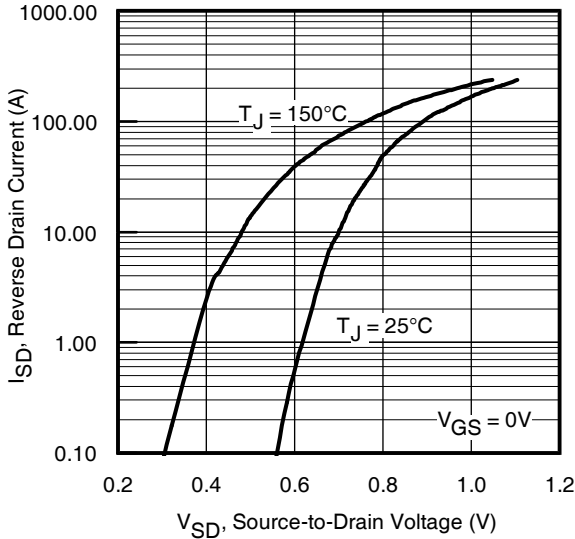

Fig 7. Typical Source-Drain Diode Forward Voltage

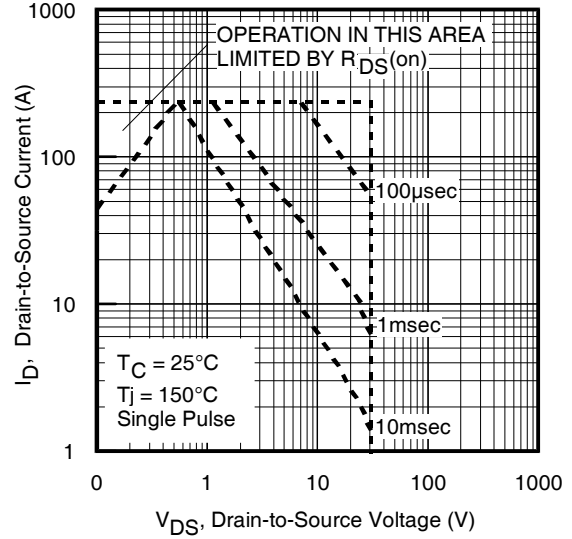

Fig 8. Maximum Safe Operating Area

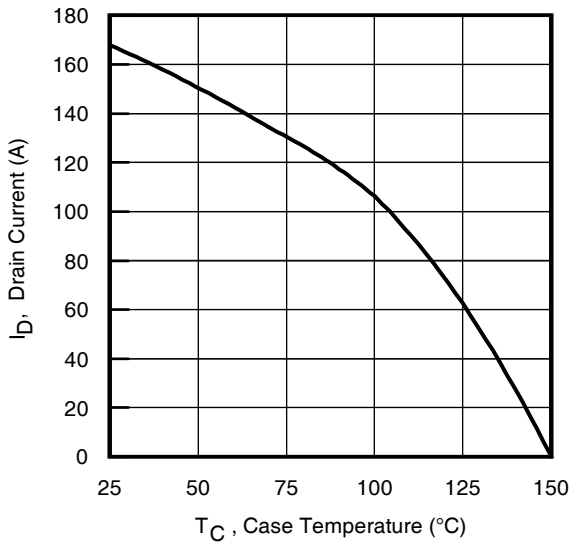

Fig 9. Maximum Drain Current vs. Case Temperature

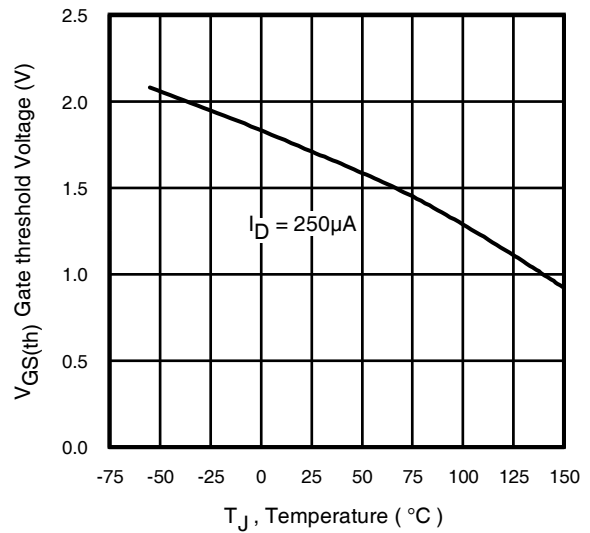

Fig 10. Threshold Voltage vs. Temperature

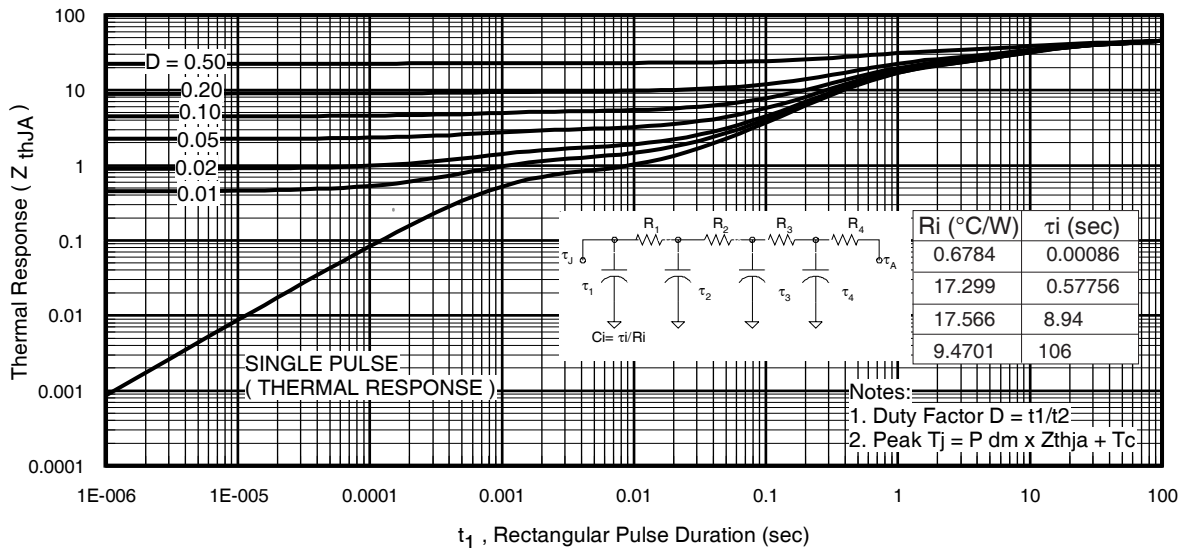

Fig 11. Maximum Effective Transient Thermal Impedance, Junction-to-Ambient

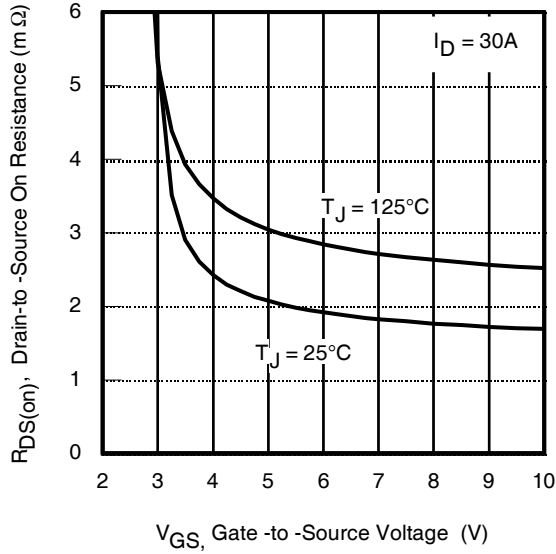

Fig 12. On-Resistance vs. Gate Voltage

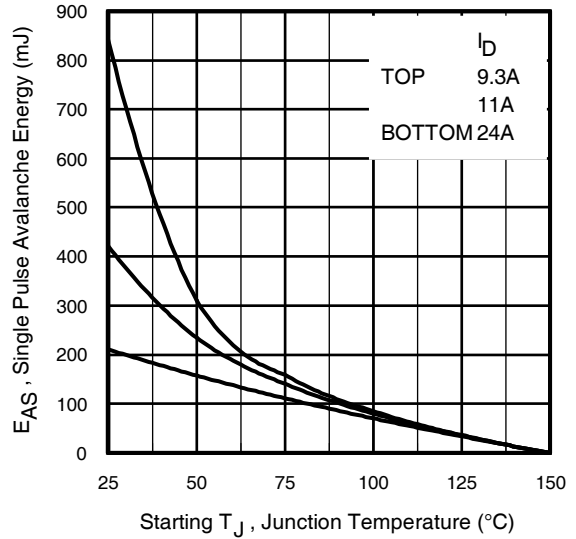

Fig 13. Maximum Avalanche Energy vs. Drain Current

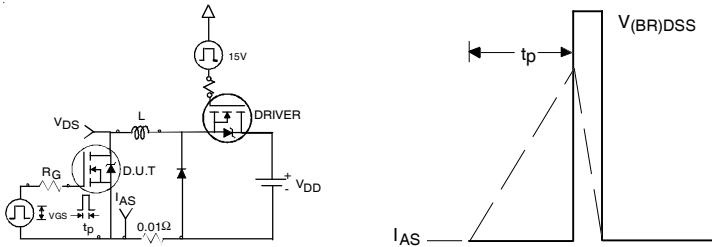

Fig 14. Unclamped Inductive Test Circuit and Waveform

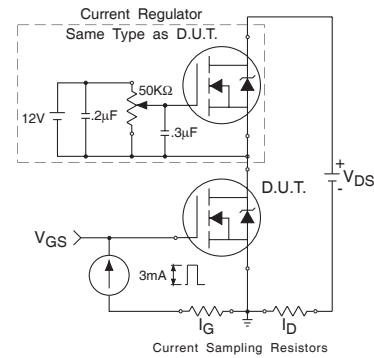

Fig 15. Gate Charge Test Circuit

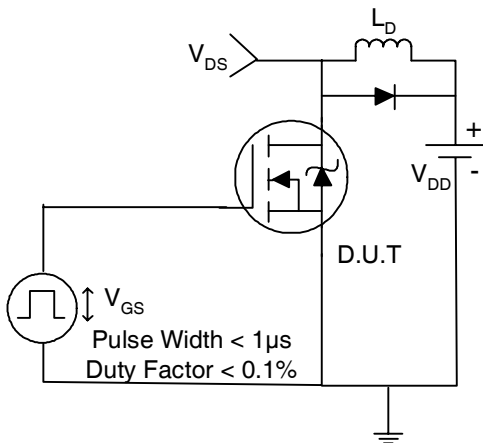

Fig 16. Switching Time Test Circuit

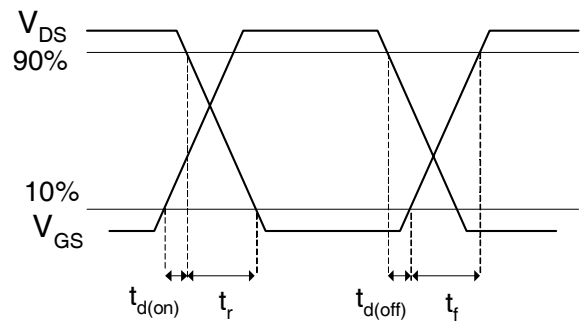

Fig 17. Switching Time Waveforms

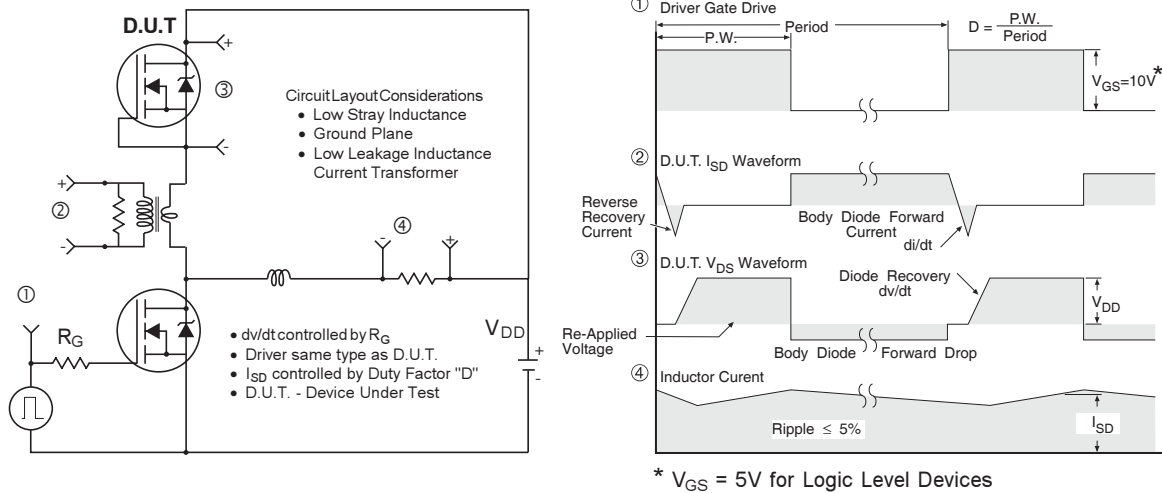

Fig 18. Peak Diode Recovery dv/dt Test Circuit for N-Channel HEXFET® Power MOSFETs

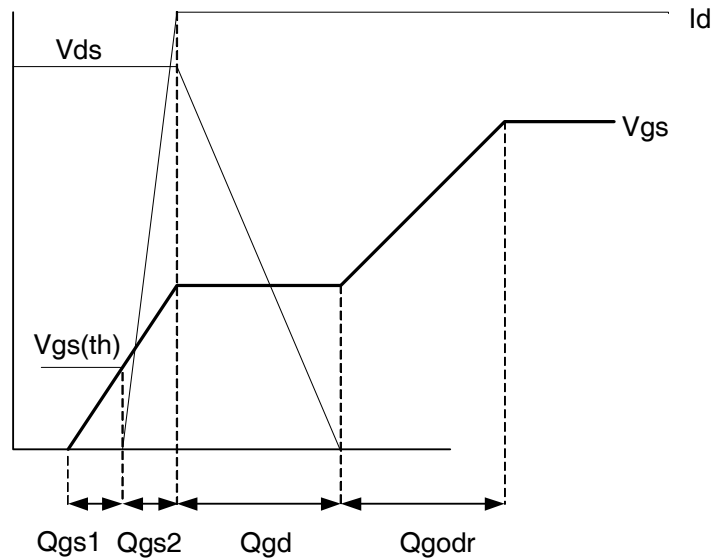
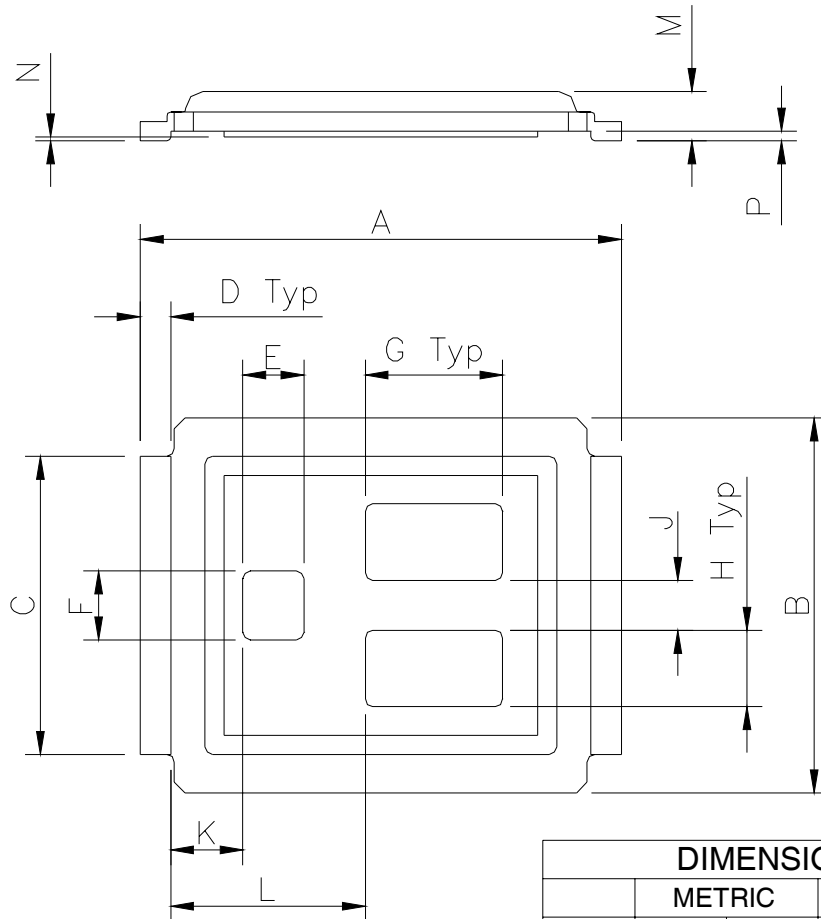

Fig 19. Gate Charge Waveform

DirectFET™ Outline Dimension, MT Outline (Medium Size Can, T-Designation).

Please see DirectFET application note AN-1035 for all details regarding the assembly of DirectFET. This includes all recommendations for stencil and substrate designs.



**NOTE: CONTROLLING
DIMENSIONS ARE IN MM**

DIMENSIONS				
CODE	METRIC		IMPERIAL	
	MIN	MAX	MIN	MAX
A	6.25	6.35	0.246	0.250
B	4.80	5.05	0.189	0.199
C	3.85	3.95	0.152	0.156
D	0.35	0.45	0.014	0.018
E	0.78	0.82	0.031	0.032
F	0.88	0.92	0.035	0.036
G	1.78	1.82	0.070	0.072
H	0.98	1.02	0.039	0.040
J	0.63	0.67	0.025	0.026
K	0.88	1.01	0.035	0.039
L	2.46	2.63	0.097	0.104
M	0.59	0.70	0.023	0.028
N	0.03	0.08	0.001	0.003
P	0.08	0.17	0.003	0.007

IRF6618/IRF6618TR1

DirectFET™ Board Footprint, MT Outline (Medium Size Can, T-Designation).

Please see DirectFET application note AN-1035 for all details regarding the assembly of DirectFET.

This includes all recommendations for stencil and substrate designs.

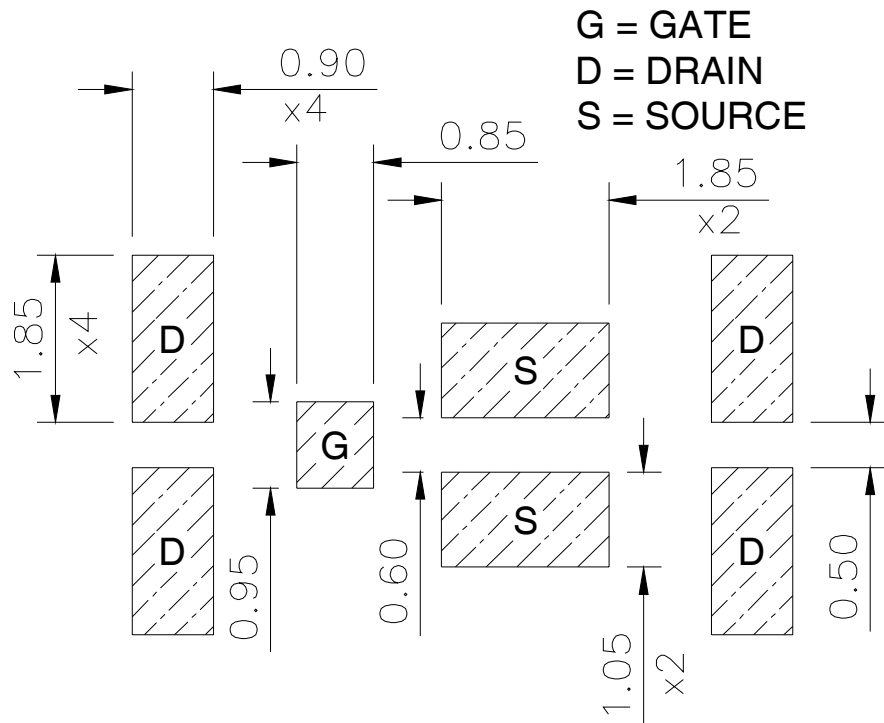
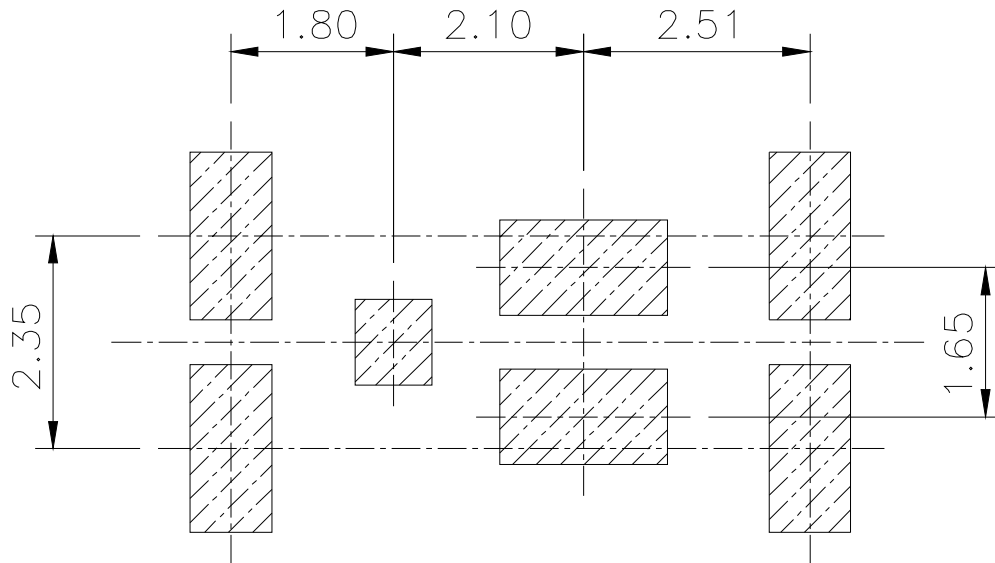

DirectFET™ Tape & Reel Dimension (Showing component orientation).

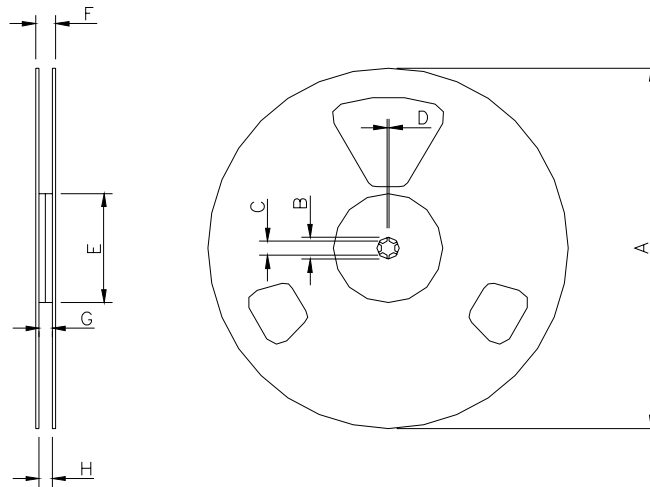

NOTE: Controlling dimensions in mm
Std reel quantity is 4800 parts. (ordered as IRF6618). For 1000 parts on 7" reel, order IRF6618TR1

REEL DIMENSIONS								
CODE	STANDARD OPTION (QTY 4800)				TR1 OPTION (QTY 1000)			
	METRIC		IMPERIAL		METRIC		IMPERIAL	
	MIN	MAX	MIN	MAX	MIN	MAX	MIN	MAX
A	330.0	N.C	12.992	N.C	177.77	N.C	6.9	N.C
B	20.2	N.C	0.795	N.C	19.06	N.C	0.75	N.C
C	12.8	13.2	0.504	0.520	13.5	12.8	0.53	0.50
D	1.5	N.C	0.059	N.C	1.5	N.C	0.059	N.C
E	100.0	N.C	3.937	N.C	58.72	N.C	2.31	N.C
F	N.C	18.4	N.C	0.724	N.C	13.50	N.C	0.53
G	12.4	14.4	0.488	0.567	11.9	12.01	0.47	N.C
H	11.9	15.4	0.469	0.606	11.9	12.01	0.47	N.C

LOADED TAPE FEED DIRECTION

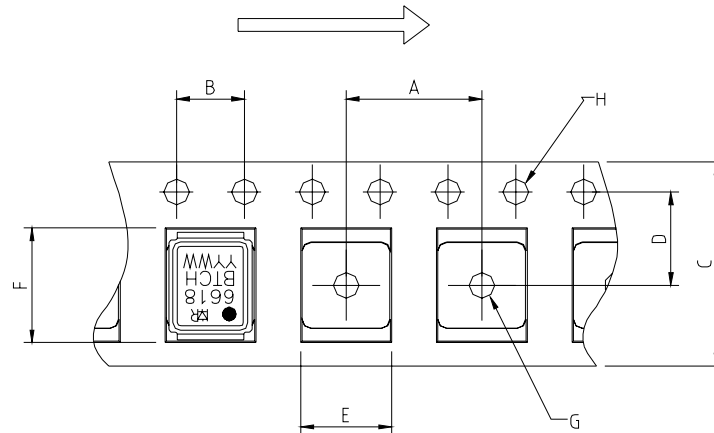

NOTE: CONTROLLING DIMENSIONS IN MM

CODE	DIMENSIONS			
	METRIC		IMPERIAL	
	MIN	MAX	MIN	MAX
A	7.90	8.10	0.311	0.319
B	3.90	4.10	0.154	0.161
C	11.90	12.30	0.469	0.484
D	5.45	5.55	0.215	0.219
E	5.10	5.30	0.201	0.209
F	6.50	6.70	0.256	0.264
G	1.50	N.C	0.059	N.C
H	1.50	1.60	0.059	0.063

DirectFET™ Part Marking

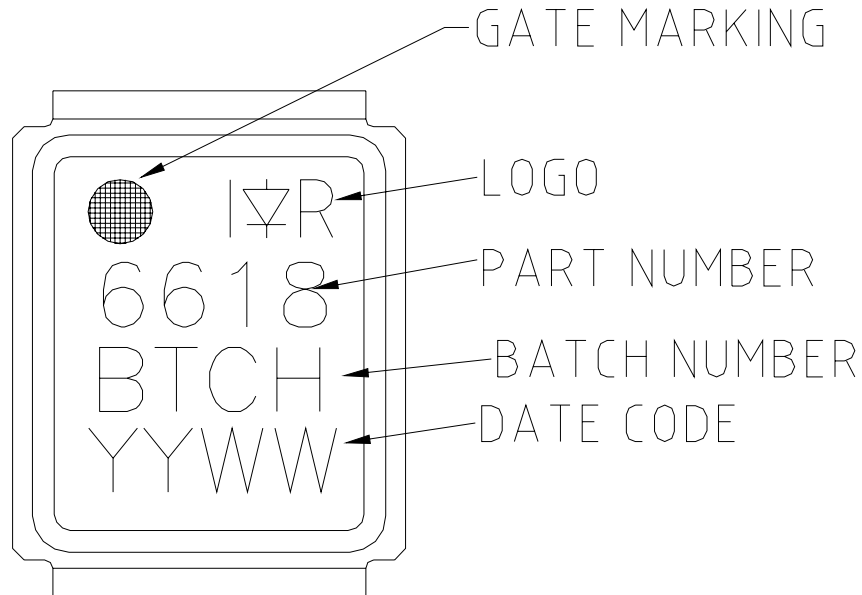

Notes:

- ① Repetitive rating; pulse width limited by max. junction temperature.
- ② Starting $T_J = 25^\circ\text{C}$, $L = 0.75\text{mH}$, $R_G = 25\Omega$, $I_{AS} = 24\text{A}$.
- ③ Pulse width $\leq 400\mu\text{s}$; duty cycle $\leq 2\%$.
- ④ Surface mounted on 1 in. square Cu board.
- ⑤ Used double sided cooling , mounting pad.
- ⑥ Mounted on minimum footprint full size board with metalized back and with small clip heatsink.
- ⑦ T_C measured with thermal couple mounted to top (Drain) of part.
- ⑧ R_θ is measured at T_J of approximately 90°C .

Data and specifications subject to change without notice.
This product has been designed and qualified for the Consumer market.
Qualification Standards can be found on IR's Web site.

International
IR Rectifier

IR WORLD HEADQUARTERS: 233 Kansas St., El Segundo, California 90245, USA Tel: (310) 252-7105
TAC Fax: (310) 252-7903

Visit us at www.irf.com for sales contact information.11/05

www.irf.com

Note: For the most current drawings please refer to the IR website at:
<http://www.irf.com/package/>