

Features

- Secondary-side high speed controller for synchronous rectification in resonant half bridge topologies
- 200V proprietary IC technology
- Max 400KHz switching frequency
- Anti-bounce logic and UVLO protection
- 4A peak turn off drive current
- Micropower start-up & ultra low quiescent current
- 10.7V gate drive clamp
- 80ns turn-off propagation delay
- Wide Vcc operating range
- Direct sensing for both Synchronous Rectifiers
- Cycle by Cycle MOT Check Circuit prevents multiple false trigger GATE pulses
- Minimal component count
- Simple design
- Lead-free

Typical Applications

- LCD & PDP TV, Telecom SMPS, AC-DC adapters

Product Summary

Topology	LLC Half-bridge
VD	200V
V _{OUT}	10.7V Clamped
I _{o+} & I _{o-} (typical)	+1A & -4A
Turn on Propagation Delay	100ns (typical)
Turn off Propagation Delay	80ns (typical)

Package Options

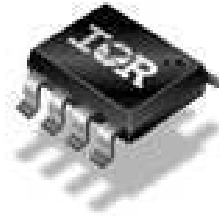

8-Lead SOIC

Typical Connection Diagram

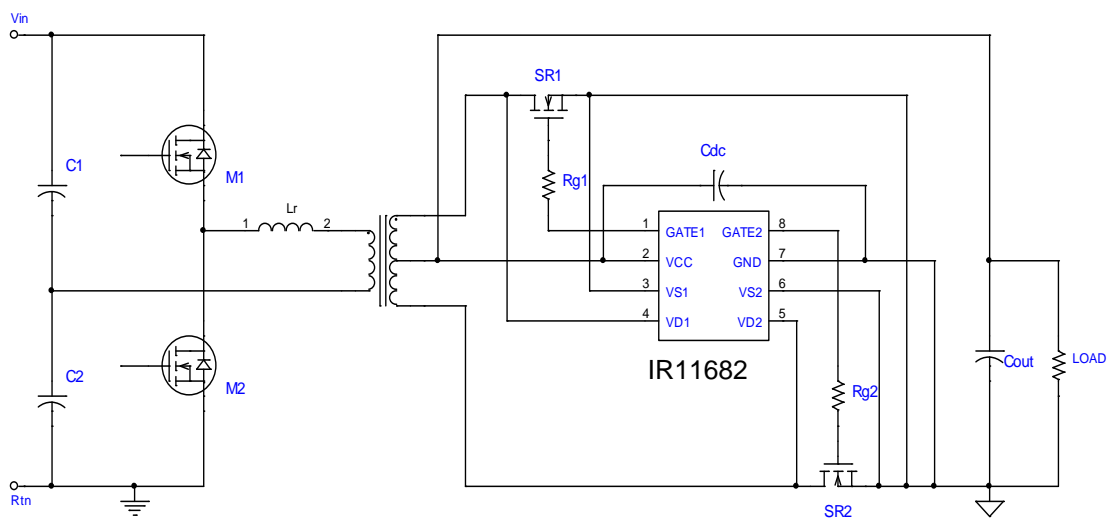

Table of Contents	Page
Description	3
Qualification Information	4
Absolute Maximum Ratings	5
Electrical Characteristics	6
Functional Block Diagram	8
Input/Output Pin Equivalent Circuit Diagram	9
Lead Definitions	10
Lead Assignments	10
Application Information and Additional Details	12
Package Details	19
Tape and Reel Details	20
Part Marking Information	21
Ordering Information	22

Description

IR11682 is a dual smart secondary-side rectifier driver IC designed to drive two N-Channel power MOSFETs used as synchronous rectifiers in resonant converter applications. The IC can control one or more paralleled N MOSFETs to emulate the behavior of Schottky diode rectifiers. The drain to source for each rectifier MOSFET voltage is sensed differentially to determine the level of the current and the power switch is turned ON and OFF in close proximity of the zero current transition. The anti shoot-through logic prevents both channels from turning on the power switches at the same time. The cycle-by-cycle MOT protection circuit can automatically detect no load condition and turn off gate driver output to avoid negative current flowing through the MOSFETs. Ruggedness and noise immunity are accomplished using an advanced blanking scheme and double-pulse suppression that allows reliable operation in fixed and variable frequency applications.

Qualification Information[†]

Qualification Level		Industrial ^{††}	
		Comments: This family of ICs has passed JEDEC's Industrial qualification. IR's Consumer qualification level is granted by extension of the higher Industrial level.	
Moisture Sensitivity Level		SOIC8N	MSL2 ^{†††} 260°C (per IPC/JEDEC J-STD-020)
ESD	Machine Model	Class B (per JEDEC standard JESD22-A115)	
	Human Body Model	Class 2 (per EIA/JEDEC standard EIA/JESD22-A114)	
IC Latch-Up Test		Class 1, Level A (per JESD78)	
RoHS Compliant		Yes	

† Qualification standards can be found at International Rectifier's web site <http://www.irf.com/>

†† Higher qualification ratings may be available should the user have such requirements. Please contact your International Rectifier sales representative for further information.

††† Higher MSL ratings may be available for the specific package types listed here. Please contact your International Rectifier sales representative for further information.

Absolute Maximum Ratings

Absolute maximum ratings indicate sustained limits beyond which damage to the device may occur. All voltage parameters are absolute voltages referenced to COM, all currents are defined positive into any lead. The thermal resistance and power dissipation ratings are measured under board mounted and still air conditions.

Parameters	Symbol	Min.	Max.	Units	Remarks
Supply Voltage	V_{CC}	-0.3	20	V	
Cont. Drain Sense Voltage	V_D	-1	200	V	
Pulse Drain Sense Voltage	V_D	-5	200	V	
Source Sense Voltage	V_S	-3	20	V	
Gate Voltage	V_{GATE}	-0.3	20	V	$V_{CC}=20V$, Gate off
Operating Junction Temperature	T_J	-40	150	°C	
Storage Temperature	T_S	-55	150	°C	
Thermal Resistance	$R_{\theta JA}$		128	°C/W	SOIC-8
Package Power Dissipation	P_D		970	mW	SOIC-8, $T_{AMB}=25^{\circ}C$
Switching Frequency	fsw		400	kHz	

Recommended Operating Conditions

For proper operation the device should be used within the recommended conditions.

Symbol	Definition	Min.	Max.	Units
V_{CC}	Supply voltage	8.6	18	V
V_{D1}, V_{D2}	Drain Sense Voltage	-3 [†]	200	
T_J	Junction Temperature	-25	125	°C
Fsw	Switching Frequency	---	400	kHz

† V_{D1}, V_{D2} -3V negative spike width $\leq 100ns$

Electrical Characteristics

V_{CC}=15V and T_A = 25°C unless otherwise specified. The output volt age and current (V_O and I_O) parameters are referenced to GND (pin7).

Supply Section

Parameters	Symbol	Min.	Typ.	Max.	Units	Remarks
Supply Voltage Operating Range	V _{CC}	8.6		18	V	GBD
V _{CC} Turn On Threshold	V _{CC ON}	7.5	8.1	8.5	V	
V _{CC} Turn Off Threshold (Under Voltage Lock Out)	V _{CC UVLO}	7	7.6	8	V	
V _{CC} Turn On/Off Hysteresis	V _{CC HYST}		0.5		V	
Operating Current	I _{CC}		14	18	mA	C _{LOAD} =1nF, f _{SW} = 400kHz
			48	60	mA	C _{LOAD} =4.7nF, f _{SW} = 400kHz
Quiescent Current	I _{QCC}		2.6	4.3	mA	
Start-up Current	I _{CC START}			140	μA	V _{CC} =V _{CC ON} - 0.1V

Comparator Section

Parameters	Symbol	Min.	Typ.	Max.	Units	Remarks
Turn-off Threshold	V _{TH1}	-12	-6	0	mV	
Turn-on Threshold	V _{TH2}	-220	-140	-80	mV	
Hysteresis	V _{HYST}		141		mV	
Input Bias Current	I _{BIAS1}		1	10	μA	V _D = -50mV
Input Bias Current	I _{BIAS2}		10	50	μA	V _D = 200V
Comparator Input Offset	V _{OFFSET}			2	mV	GBD

One-Shot Section

Parameters	Symbol	Min.	Typ.	Max.	Units	Remarks
Blanking pulse duration	t _{BLANK}	8	17	25	μs	
Reset Threshold	V _{TH3}		2.5		V	V _{CC} =10V – GBD
			5.4		V	V _{CC} =20V – GBD
Hysteresis	V _{HYST3}		40		mV	V _{CC} =10V – GBD

Minimum On Time Section

Parameters	Symbol	Min.	Typ.	Max.	Units	Remarks
Minimum on time	T _{Onmin}	600	850	1100	ns	

Electrical Characteristics

V_{CC}=15V and T_A = 25°C unless otherwise specified. The output volt age and current (V_O and I_O) parameters are referenced to GND (pin7).

Gate Driver Section

Parameters	Symbol	Min.	Typ.	Max.	Units	Remarks
Gate Low Voltage	V _{GLO}		0.3	0.5	V	I _{GATE} = 200mA
Gate High Voltage	V _{GTH}	8.5	10.7	13.5	V	V _{CC} =12V-18V (internally clamped)
Rise Time	t _{r1}		10		ns	C _{LOAD} = 1nF
	t _{r2}		80		ns	C _{LOAD} = 4.7nF
Fall Time	t _{f1}		5		ns	C _{LOAD} = 1nF
	t _{f2}		25		ns	C _{LOAD} = 4.7nF
Turn on Propagation Delay	t _{DOn}		100	200	ns	V _{DS} to V _{GATE} -100mV overdrive
Turn off Propagation Delay	t _{Doff}		80	120	ns	V _{DS} to V _{GATE} -100mV overdrive
Pull up Resistance	r _{up}		5		Ω	I _{GATE} = 15mA – GBD
Pull down Resistance	r _{down}		1.2		Ω	I _{GATE} = -200mA – GBD
Output Peak Current (source)	I _{O source}		1		A	C _{LOAD} = 1nF – GBD
Output Peak Current (sink)	I _{O sink}		4		A	C _{LOAD} = 1nF – GBD

Functional Block Diagram

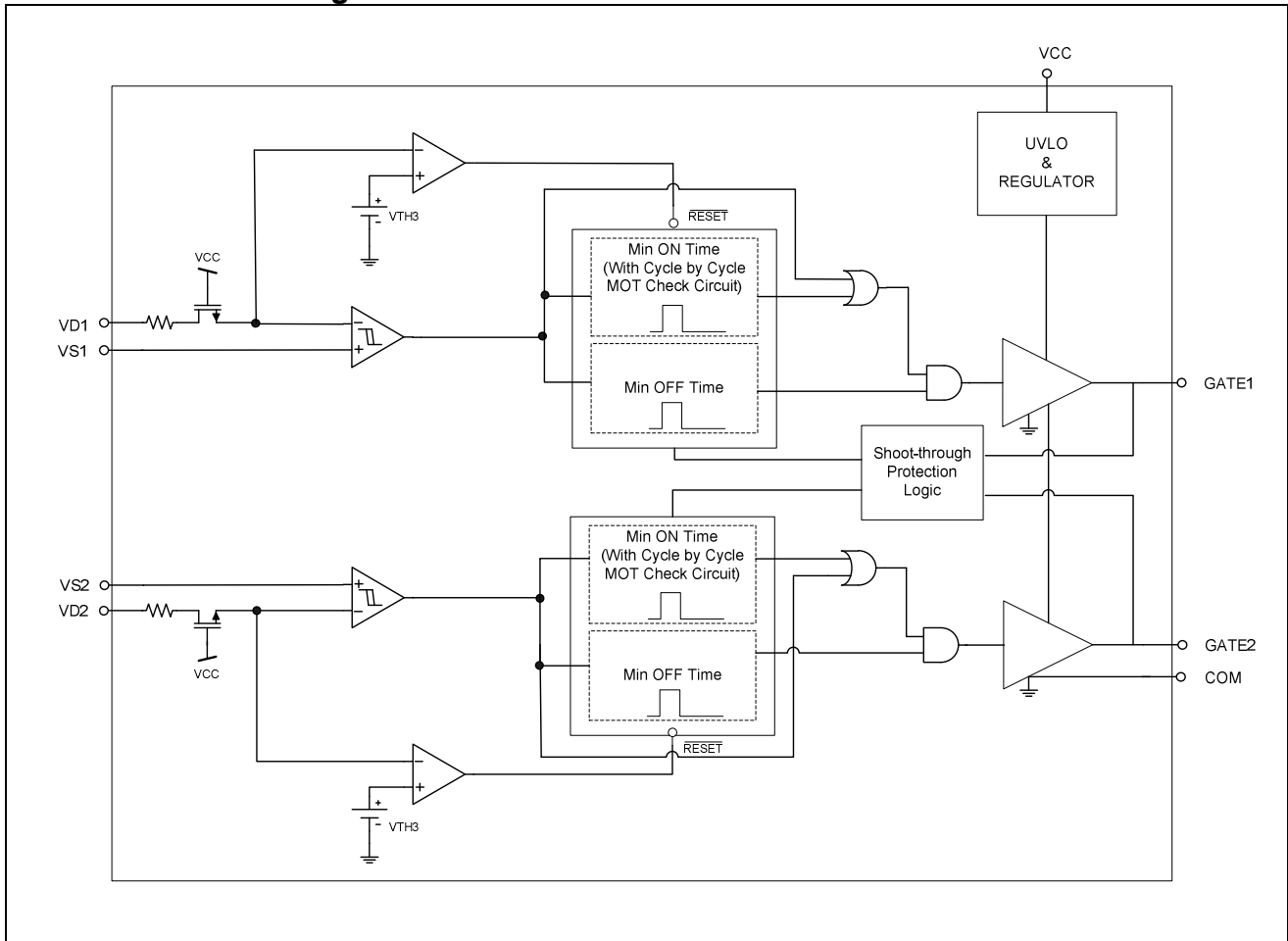

I/O Pin Equivalent Circuit Diagram

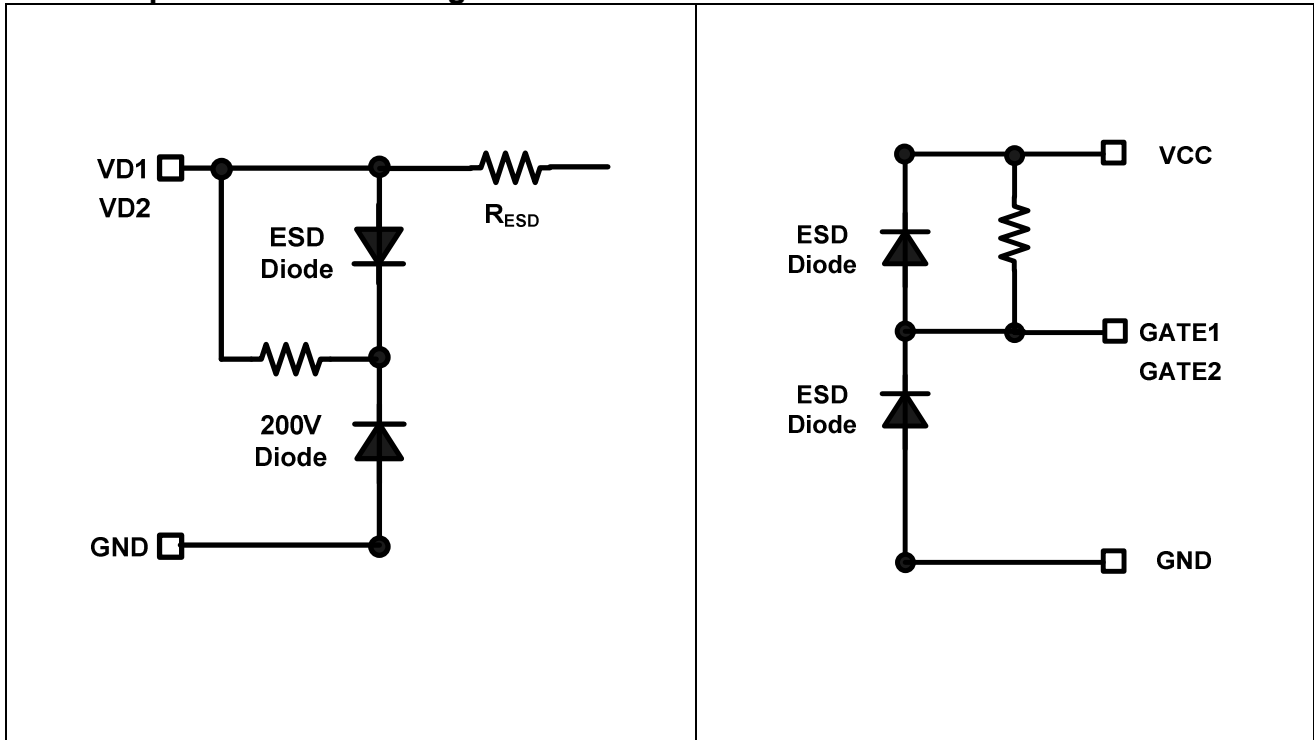

Lead Definitions

PIN#	Symbol	Description
1	GATE1	Gate Drive Output 1
2	VCC	Supply Voltage
3	VS1	Sync FET 1 Source Voltage Sense
4	VD1	Sync FET 1 Drain Voltage Sense
5	VD2	Sync FET 2 Drain Voltage Sense
6	VS2	Sync FET 2 Source Voltage Sense
7	GND	Analog and Power Ground
8	GATE2	Gate Drive Output 2

Lead Assignments

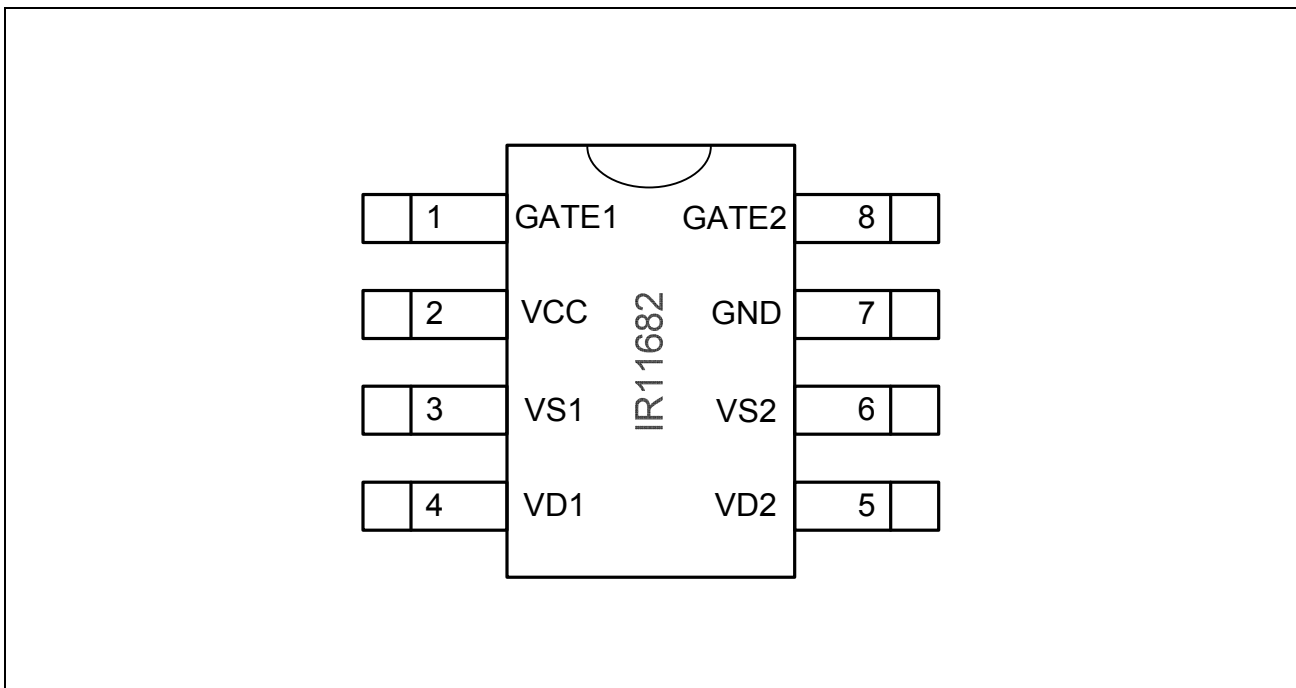

Detailed Pin Description

VCC: Power Supply

This is the supply voltage pin of the IC and it is monitored by the under voltage lockout circuit. It is possible to turn off the IC by pulling this pin below the minimum turn off threshold voltage, without damage to the IC.

To prevent noise problems, a bypass ceramic capacitor connected to Vcc and COM should be placed as close as possible to the IR11682. This pin is not internally clamped.

GND: Ground

This is ground potential pin of the integrated control circuit. The internal devices and gate driver are referenced to this point.

VD1 and VD2: Drain Voltage Sense

These are the two high-voltage pins used to sense the drain voltage of the two SR power MOSFETs. Routing between the drain of the MOSFET and the IC pin must be particularly optimized.

Additional RC filter is not necessary but could be added to VD1 and VD2 pins to increase noise immunity.

For applications which VD voltage exceeds 100V, a 1Kohm to 2Kohm VD resistor is recommended to be added between the drain of SR MOSFET and VD pin. The VD resistor helps to limit the switching loss of VD pins.

VS1 and VS2: Source Voltage Sense

These are the two differential sense pins for the two source pins of the two SR power MOSFETs. This pin must not be connected directly to the GND pin (pin 7) but must be used to create a Kelvin contact as close as possible to the power MOSFET source pin.

GATE1 and GATE2: Gate Drive Outputs

These are the two gate drive outputs of the IC. The gate voltage is internally clamped and has a +1A/-4A peak drive capability. Although this pin can be directly connected to the synchronous rectifier (SR) MOSFET gate, the use of gate resistor is recommended (specifically when putting multiple MOSFETs in parallel). Care must be taken in order to keep the gate loop as short and as small as possible in order to achieve optimal switching performance.

Application Information and Additional Details

State Diagram

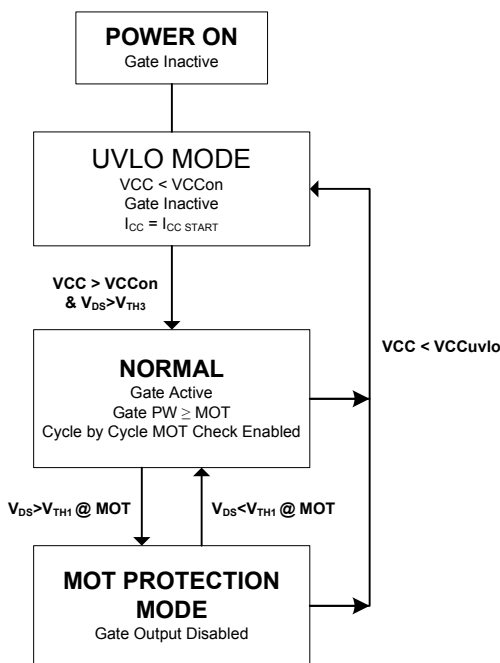

UVLO Mode:

The IC is in the UVLO mode when the VCC pin voltage is below VCCUVLO. The UVLO mode is accessible from any other state of operation. In the UVLO state, most of the internal circuitry is unbiased and the IC draws a quiescent current of ICCSTART.

The IC remains in the UVLO condition until the voltage on the VCC pin exceeds the VCC turn on threshold voltage, VCC ON.

Normal Mode:

Once Vcc exceeds the UVLO voltage, the IC is ready to go into Normal mode. The GATE outputs are activated when the VDS sensed on the MOSFET crosses VTH3. This function will prevent the GATE to turn-on towards the end of a switching cycle and prevent reverse current in MOT time. In Normal mode the gate drivers are operating and the IC will draw a maximum of ICC from the supply voltage source.

MOT Protection Mode

If the secondary current conduction time is shorter than the MOT (Minimum On Time) time, the next driver output is disabled. This function can avoid reverse current that occurs when the system works at very light/no load conditions and reduce system standby power consumption by disabling GATE outputs. The IC automatically goes back to normal operation mode once the load increases to a level and the secondary current conduction time is longer than MOT.

General Description

The IR11682 Dual Smart Rectifier controller IC is the industry first dedicated high-voltage controller IC for synchronous rectification in resonant converter applications. The IC can emulate the operation of the two secondary rectifier diodes by correctly driving the synchronous rectifier (SR) MOSFETs in the two secondary legs.

The core of this device are two high-voltage, high speed comparators which sense the drain to source voltage of the MOSFETs differentially. The device current is sensed using the R_{DSON} as a shunt resistance and the GATE pin of the MOSFET is driven accordingly. Dedicated internal logic then manages to turn the power device on and off in close proximity of the zero current transition.

IR11682 further simplifies synchronous rectifier control by offering the following power management features:

- Wide VCC operating range allows the IC to be directly powered from the converter output
- Shoot through protection logic that prevents both the GATE outputs from the IC to be high at the same time
- Device turn ON and OFF in close proximity of the zero current transition with low turn-on and turn-off propagation delays; eliminates reactive power flow between the output capacitors and power transformer
- Internally clamped gate driver outputs that significantly reduce gate losses.

The SmartRectifier™ control technique is based on sensing the voltage across the MOSFET and comparing it with two negative thresholds to determine the turn on and off transitions for the device. The rectifier current is sensed by the input comparators using the power MOSFET R_{DSON} as a shunt resistance and its GATE is driven depending on the level of the sensed voltage vs. the 3 thresholds shown below.

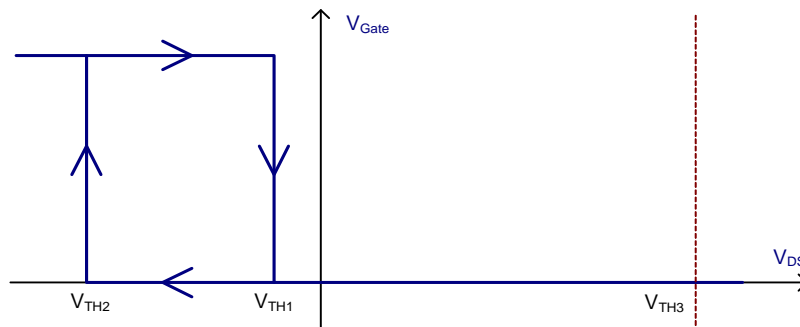

Figure 1: Input comparator thresholds

Turn-on phase

When the conduction phase of the SR FET is initiated, current will start flowing through its body diode, generating a negative V_{DS} voltage across it. The body diode has generally a much higher voltage drop than the one caused by the MOSFET on resistance and therefore will trigger the turn-on threshold V_{TH2} .

When V_{TH2} is triggered, IR11682 will drive the gate of MOSFET on which will in turn cause the conduction voltage V_{DS} to drop down to $I_D \cdot R_{DSON}$. This drop is usually accompanied by some amount of ringing, that could trigger the input comparator to turn off; hence, a fixed Minimum On Time (MOT) blanking period is used that will maintain the power MOSFET on for a minimum amount of time.

The fixed MOT limits the minimum conduction time of the secondary rectifiers and hence, the maximum switching frequency of the converter.

Turn-off phase

Once the SR MOSFET has been turned on, it will remain on until the rectified current will decay to the level where V_{DS} will cross the turn-off threshold V_{TH1} .

Since the device currents are sinusoidal here, the device V_{DS} will cross the V_{TH1} threshold with a relatively low dV/dt . Once the threshold is crossed, the current will start flowing again through the body diode, causing the V_{DS} voltage to jump negative. Depending on the amount of residual current, V_{DS} may once again trigger the turn-on threshold; hence, V_{TH2} is blanked for a time duration t_{BLANK} after V_{TH1} is triggered. When the device V_{DS} crosses the positive reset threshold V_{TH3} , t_{BLANK} is terminated and the IC is ready for next conduction cycle as shown below.

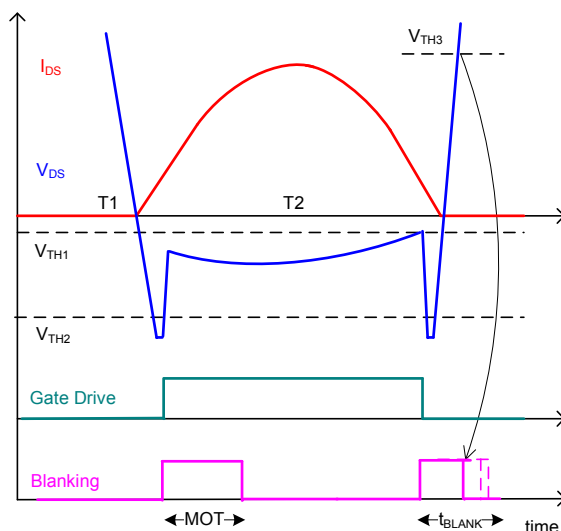

Figure 2: Secondary currents and voltages

MOT protection

At very light load or no load condition, the current in SR FET will become discontinuous and could be shorter than MOT time in some system. If this happens, the SR FET current will flow from drain to source at the end of MOT. The reverse current discharges output capacitor; stores the energy in transformer and causes resonant on V_{DS} voltage once the SR FET turns off. The resonant could turn on the gate of IR11682, caused more reverse current and thus subsequent multi false triggering as shown below in Figure 3.

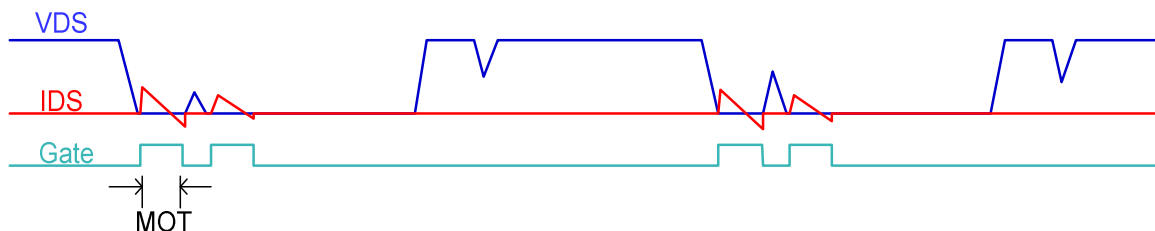

Figure 3: Waveform without MOT protection

The cycle-by-cycle MOT protection circuit can detect the reverse current situation and disable the next output gate pulse to avoid this issue. The internal comparator and MOT pulse generator still work under the protection mode. So the circuit can continuously monitor the load current and come back to normal working mode once the load current conduction time increased to longer than MOT. This circuit helps to reduce standby power losses. It also can prevent voltage spike that caused by false triggering at light load.

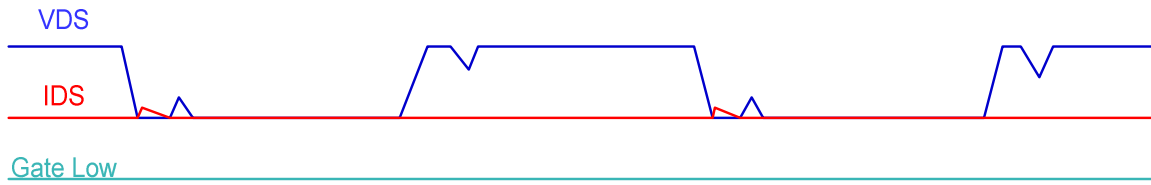

Figure 4: Waveform under MOT protection mode

General Timing Waveform

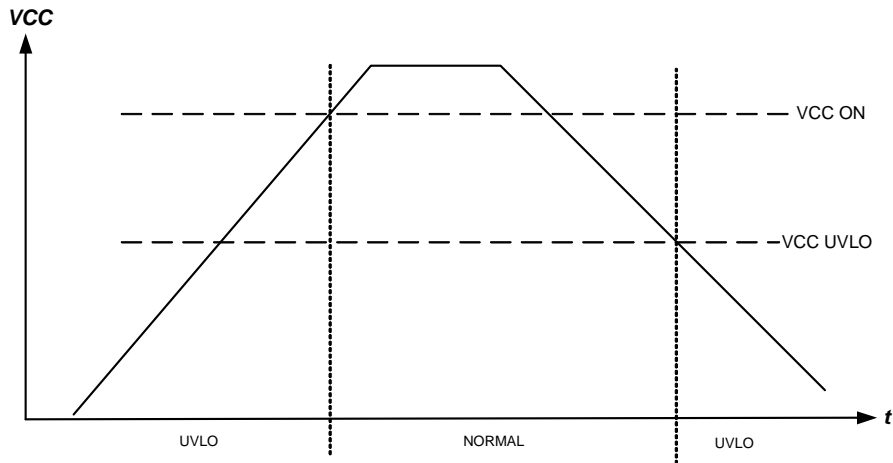

Figure 5: Vcc UVLO

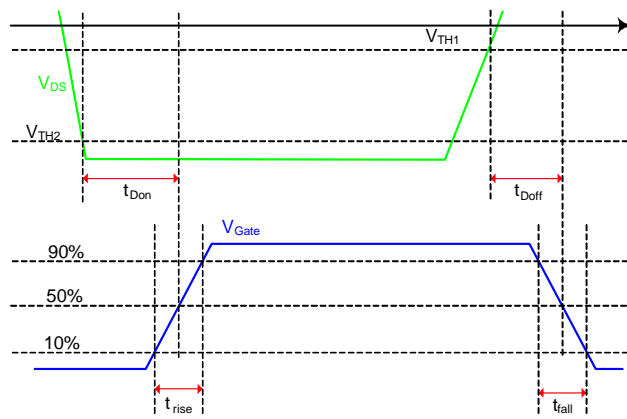

Figure 6: Timing waveform

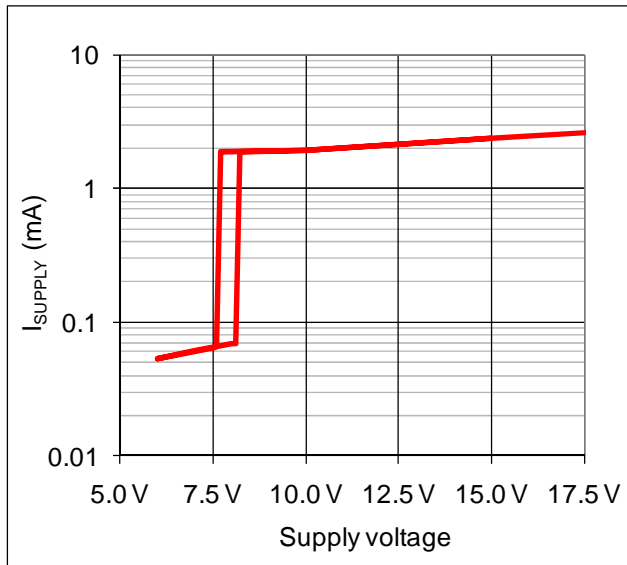

Figure 7: Supply Current vs. Supply Voltage

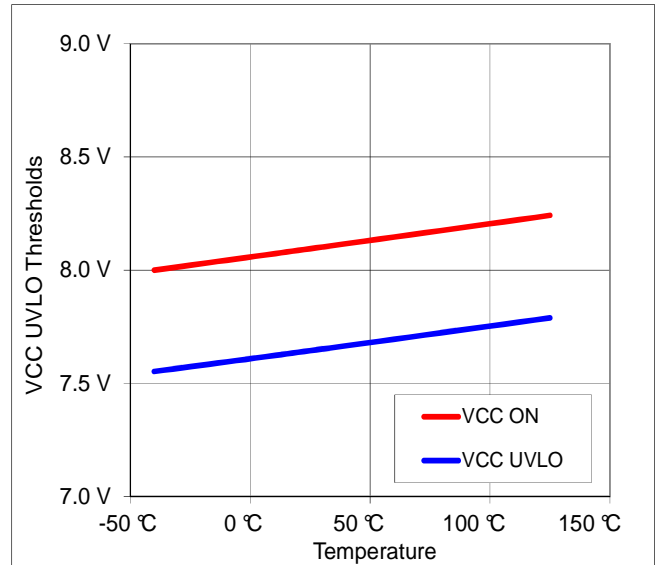

Figure 8: Undervoltage Lockout vs. Temperature

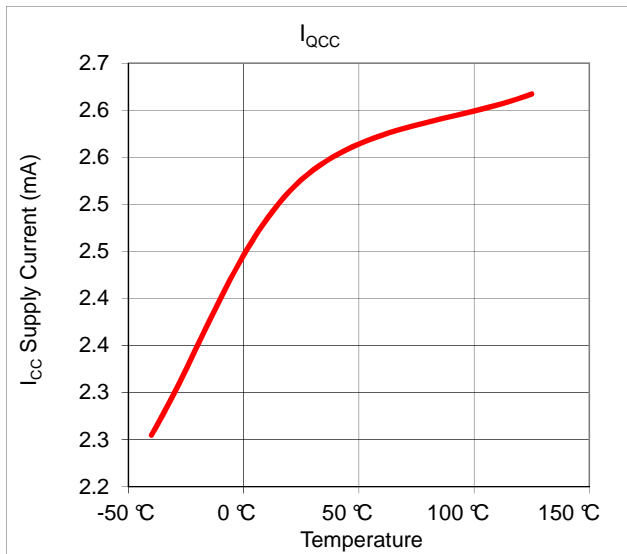

Figure 9: Icc Quiescent Current vs. Temperature

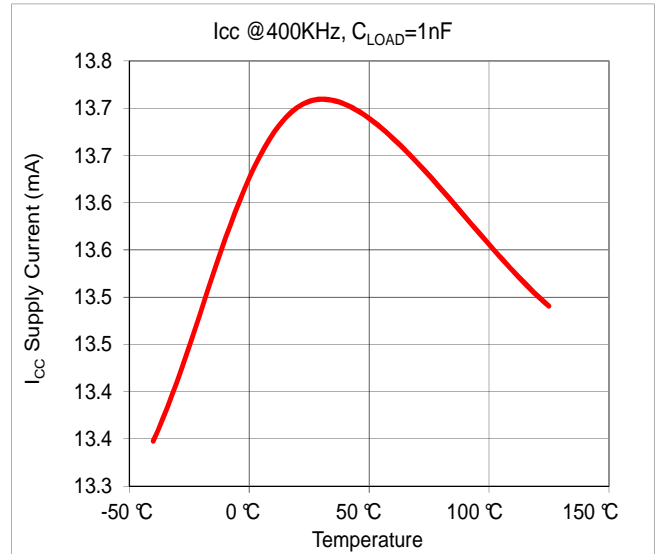

Figure 10: Icc Supply Current @1nF Load vs. Temperature

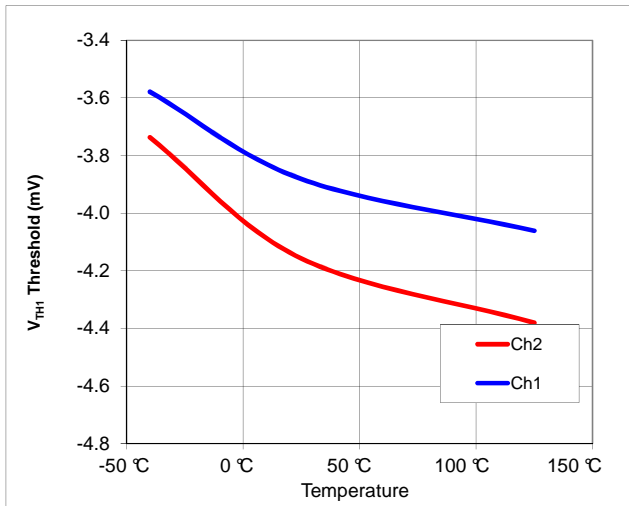

Figure 11: V_{TH1} vs. Temperature

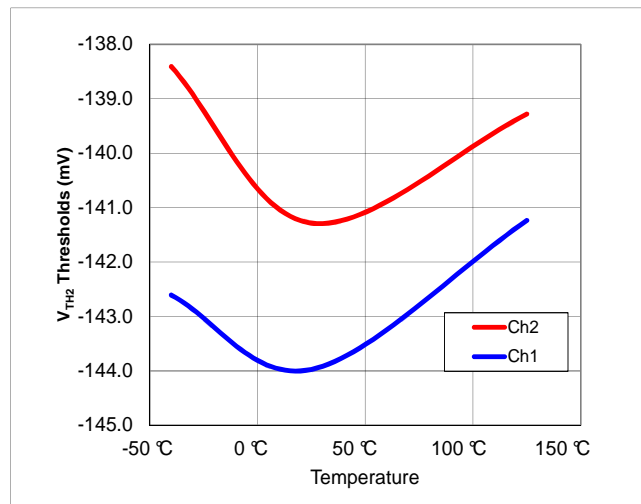

Figure 12: V_{TH2} vs. Temperature

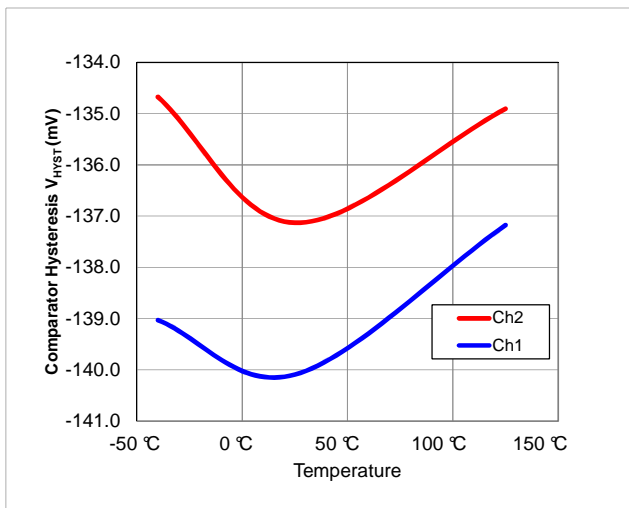

Figure 13: Comparator Hysteresis vs. Temperature

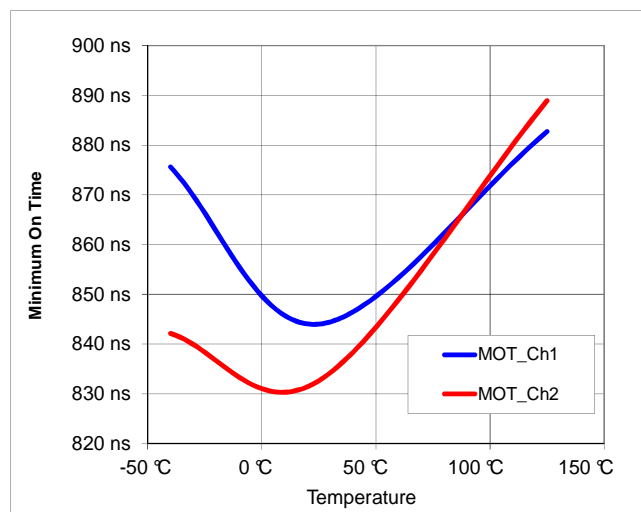

Figure 14: MOT vs Temperature

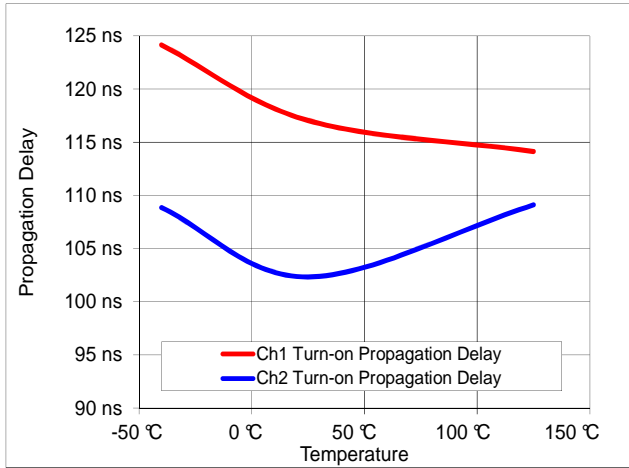

Figure 15: Turn-on Propagation Delay vs. Temperature

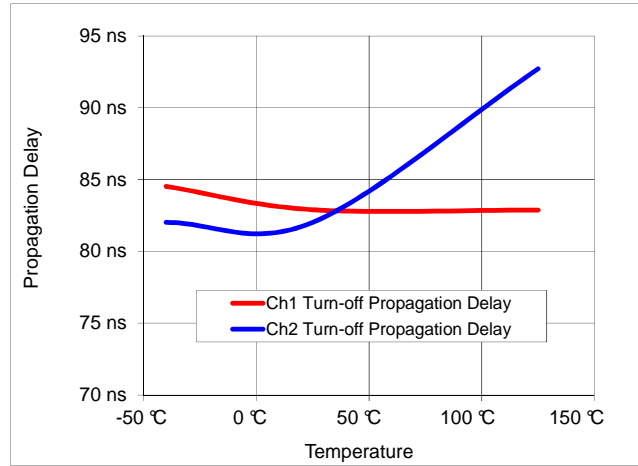

Figure 16: Turn-off Propagation Delay vs. Temperature

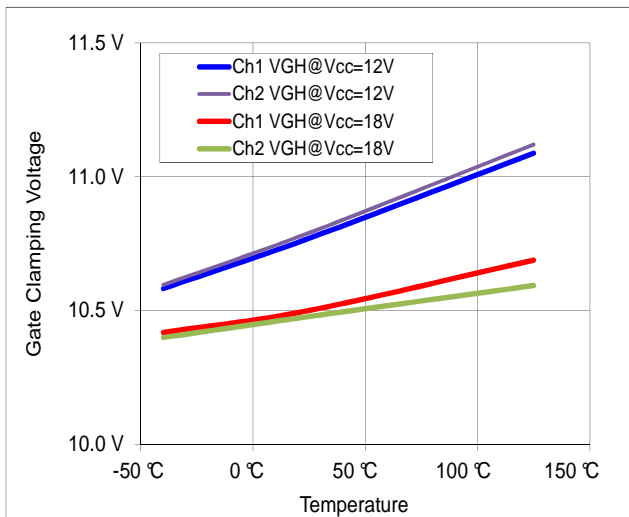

Figure 17: Gate Clamping Voltage vs. Temperature

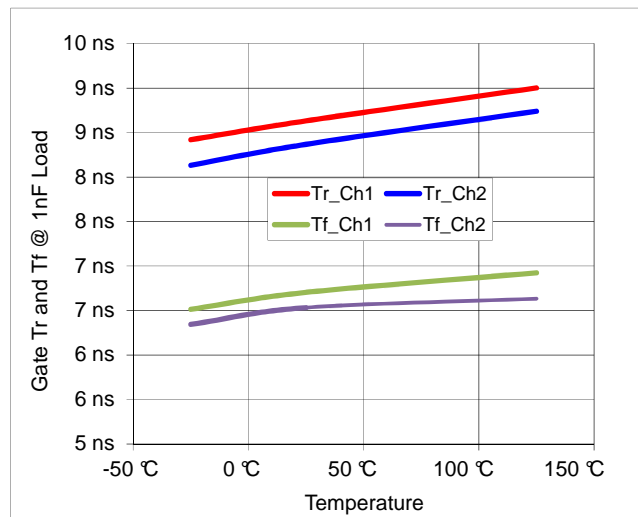
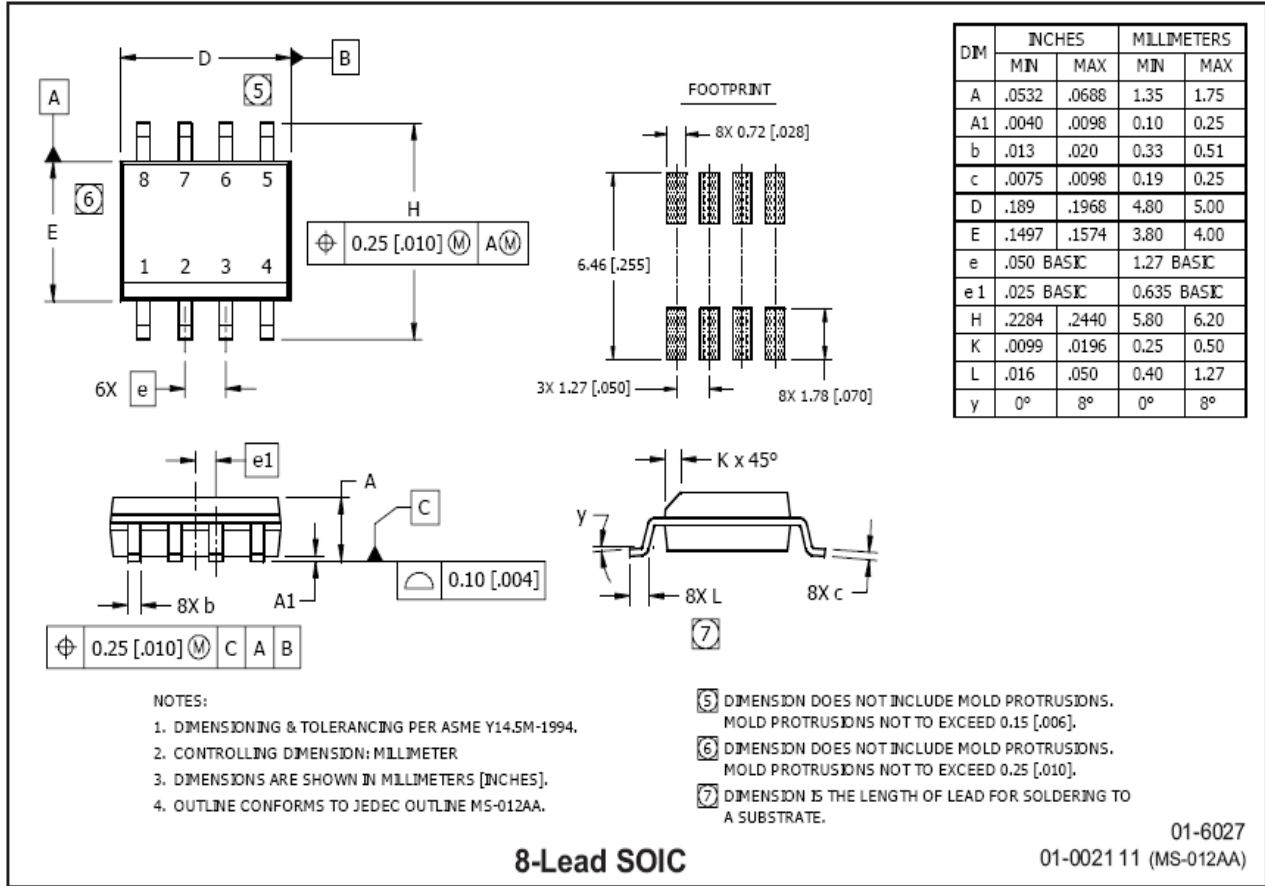
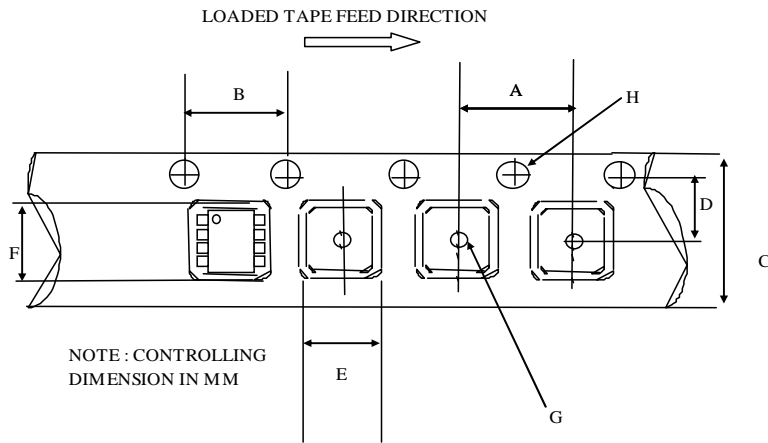

Figure 18: Gate Output Tr and Tf time @ 1nF Load vs. Temperature

Package Details: SOIC8N



Tape and Reel Details: SOIC8N



CARRIER TAPE DIMENSION FOR 8SOICN

Code	Metric		Imperial	
	Min	Max	Min	Max
A	7.90	8.10	0.311	0.318
B	3.90	4.10	0.153	0.161
C	11.70	12.30	0.46	0.484
D	5.45	5.55	0.214	0.218
E	6.30	6.50	0.248	0.255
F	5.10	5.30	0.200	0.208
G	1.50	n/a	0.059	n/a
H	1.50	1.60	0.059	0.062

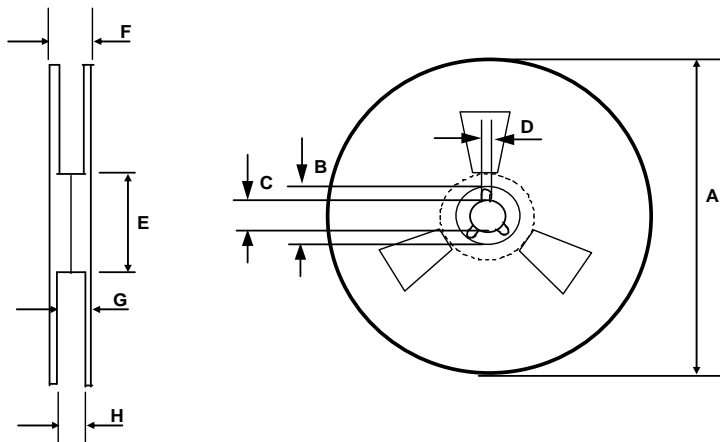

REEL DIMENSIONS FOR 8SOICN

Code	Metric		Imperial	
	Min	Max	Min	Max
A	329.60	330.25	12.976	13.001
B	20.95	21.45	0.824	0.844
C	12.80	13.20	0.503	0.519
D	1.95	2.45	0.767	0.096
E	98.00	102.00	3.858	4.015
F	n/a	18.40	n/a	0.724
G	14.50	17.10	0.570	0.673
H	12.40	14.40	0.488	0.566

Part Marking Information

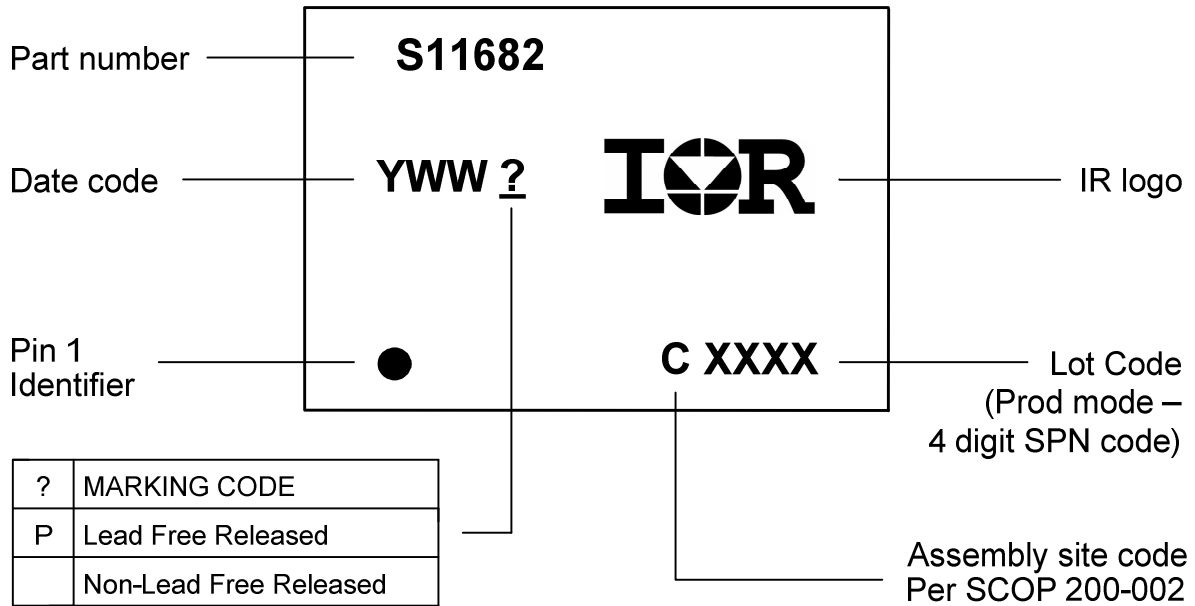

Ordering Information

Base Part Number	Package Type	Standard Pack		Complete Part Number
		Form	Quantity	
IR11682	SOIC8N	Tube/Bulk	95	IR11682SPBF
		Tape and Reel	2500	IR11682STRPBF

The information provided in this document is believed to be accurate and reliable. However, International Rectifier assumes no responsibility for the consequences of the use of this information. International Rectifier assumes no responsibility for any infringement of patents or of other rights of third parties which may result from the use of this information. No license is granted by implication or otherwise under any patent or patent rights of International Rectifier. The specifications mentioned in this document are subject to change without notice. This document supersedes and replaces all information previously supplied.

For technical support, please contact IR's Technical Assistance Center
<http://www.irf.com/technical-info/>

WORLD HEADQUARTERS:
 233 Kansas St., El Segundo, California 90245
 Tel: (310) 252-7105