

# 100302

## Low Power Quint 2-Input OR/NOR Gate

### General Description

The 100302 is a monolithic quint 2-input OR/NOR gate with common enable. All inputs have 50 kΩ pull-down resistors and all outputs are buffered.

### Features

- 43% power reduction of the 100102
- 2000V ESD protection
- Pin/function compatible with 100102
- Voltage compensated operating range = -4.2V to -5.7V
- Available to industrial grade temperature range (PLCC package only)

### Ordering Code:

| Order Number | Package Number | Package Description  |
|--------------|----------------|--|
| 100302SC     | M24B           | 24-Lead Small Outline Integrated Circuit (SOIC), JEDEC MS-013, 0.300 Wide  |
| 100302PC     | N24E           | 24-Lead Plastic Dual-In-Line Package (PDIP), JEDEC MS-010, 0.400 Wide  |
| 100302QC     | V28A           | 28-Lead Plastic Lead Chip Carrier (PLCC), JEDEC MO-047, 0.450 Square   |
| 100302QI     | V28A           | 28-Lead Plastic Lead Chip Carrier (PLCC), JEDEC MO-047, 0.450 Square Industrial Temperature Range (-40°C to +85°C) |

Devices also available in Tape and Reel. Specify by appending the suffix letter "X" to the ordering code.

### Connection Diagrams

24-Pin DIP/SOIC

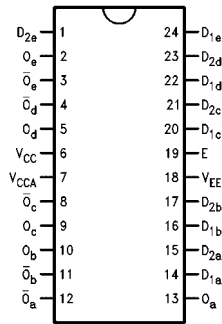

28-Pin PLCC

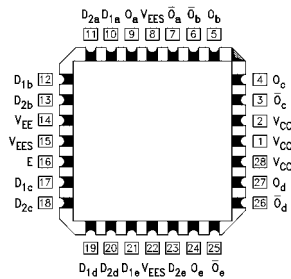

### Pin Descriptions

| Pin Names                        | Description                |
|----------------------------------|----------------------------|
| D <sub>na</sub> -D <sub>ne</sub> | Data Inputs                |
| E                                | Enable Input               |
| O <sub>a</sub> -O <sub>e</sub>   | Data Outputs               |
| $\bar{O}_a$ - $\bar{O}_e$        | Complementary Data Outputs |

100302

**Logic Symbol**

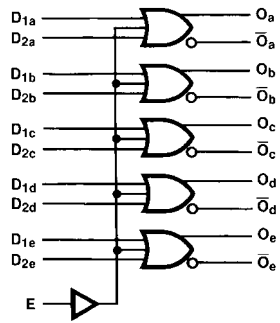

**Truth Table**

| D <sub>1X</sub> | D <sub>2X</sub> | E | O <sub>X</sub> | $\bar{O}_X$ |
|-----------------|-----------------|---|----------------|-------------|
| L               | L               | L | L              | H           |
| L               | L               | H | H              | L           |
| L               | H               | L | H              | L           |
| L               | H               | H | H              | L           |
| H               | L               | L | H              | L           |
| H               | L               | H | H              | L           |
| H               | H               | L | H              | L           |
| H               | H               | H | H              | L           |

H = HIGH Voltage Level

L = LOW Voltage Level

**Absolute Maximum Ratings**(Note 1)

|  |                   |
|--|-------------------|
| Storage Temperature ( $T_{STG}$ )      | -65°C to +150°C   |
| Maximum Junction Temperature ( $T_J$ ) | +150°C            |
| $V_{EE}$ Pin Potential to Ground Pin   | -7.0V to +0.5V    |
| Input Voltage (DC)                     | $V_{EE}$ to +0.5V |
| Output Current (DC Output HIGH)        | -50 mA            |
| ESD (Note 2)                           | ≥2000V            |

**Recommended Operating Conditions**

|                             |            |                |
|-----------------------------|------------|----------------|
| Case Temperature ( $T_C$ )  | Commercial | 0°C to +85°C   |
|                             | Industrial | -40°C to +85°C |
| Supply Voltage ( $V_{EE}$ ) |            | -5.7V to -4.2V |

**Note 1:** The "Absolute Maximum Ratings" are those values beyond which the safety of the device cannot be guaranteed. The device should not be operated at these limits. The parametric values defined in the Electrical Characteristics tables are not guaranteed at the absolute maximum rating. The "Recommended Operating Conditions" table will define the conditions for actual device operation.

**Note 2:** ESD testing conforms to MIL-STD-883, Method 3015.

**Commercial Version****DC Electrical Characteristics** (Note 3)

$V_{EE} = -4.2V$  to  $-5.7V$ ,  $V_{CC} = V_{CCA} = GND$ ,  $T_C = 0^\circ C$  to  $+85^\circ C$

| Symbol    | Parameter            | Min   | Typ   | Max   | Units | Conditions                              |                           |
|-----------|----------------------|-------|-------|-------|-------|---|---------------------------|
| $V_{OH}$  | Output HIGH Voltage  | -1025 | -955  | -870  | mV    | $V_{IN} = V_{IH(Max)}$ or $V_{IL(Min)}$ | Loading with 50Ω to -2.0V |
| $V_{OL}$  | Output LOW Voltage   | -1830 | -1705 | -1620 | mV    |   |                           |
| $V_{OHC}$ | Output HIGH Voltage  | -1035 |       |       | mV    | $V_{IN} = V_{IH(Min)}$ or $V_{IL(Max)}$ | Loading with 50Ω to -2.0V |
| $V_{OLC}$ | Output LOW Voltage   |       |       | -1610 | mV    |   |                           |
| $V_{IH}$  | Input HIGH Voltage   | -1165 |       | -870  | mV    | Guaranteed HIGH Signal for All Inputs   |                           |
| $V_{IL}$  | Input LOW Voltage    | -1830 |       | -1475 | mV    | Guaranteed LOW Signal for All Inputs    |                           |
| $I_{IL}$  | Input LOW Current    | 0.50  |       |       | μA    | $V_{IN} = V_{IL(Min)}$                  |                           |
| $I_{IH}$  | Input HIGH Current   |       |       | 240   | μA    | $V_{IN} = V_{IH(Max)}$                  |                           |
| $I_{EE}$  | Power Supply Current | -45   | -36   | -20   | mA    | Inputs OPEN                             |                           |

**Note 3:** The specified limits represent the "worst case" value for the parameter. Since these values normally occur at the temperature extremes, additional noise immunity and guardbanding can be achieved by decreasing the allowable system operating ranges. Conditions for testing shown in the tables are chosen to guarantee operation under "worst case" conditions.

**DIP AC Electrical Characteristics**

$V_{EE} = -4.2V$  to  $-5.7V$ ,  $V_{CC} = V_{CCA} = GND$

| Symbol    | Parameter              | $T_C = 0^\circ C$ |      | $T_C = +25^\circ C$ |      | $T_C = +85^\circ C$ |      | Units | Conditions               |
|-----------|------------------------|-------------------|------|---------------------|------|---------------------|------|-------|--------------------------|
|           |                        | Min               | Max  | Min                 | Max  | Min                 | Max  |       |                          |
| $t_{PLH}$ | Propagation Delay      | 0.50              | 1.15 | 0.50                | 1.15 | 0.50                | 1.25 | ns    | Figures 1, 2<br>(Note 4) |
| $t_{PHL}$ | Data to Output         |                   |      |                     |      |                     |      |       |                          |
| $t_{PLH}$ | Propagation Delay      | 0.70              | 1.90 | 0.70                | 1.90 | 0.80                | 2.00 | ns    |                          |
| $t_{PHL}$ | Enable to Output       |                   |      |                     |      |                     |      |       |                          |
| $t_{TLH}$ | Transition Time        | 0.40              | 1.20 | 0.40                | 1.20 | 0.40                | 1.20 | ns    | Figures 1, 2             |
| $t_{THL}$ | 20% to 80%, 80% to 20% |                   |      |                     |      |                     |      |       |                          |

**Note 4:** The propagation delay specified is for single output switching. Delays may vary up to 100 ps with multiple outputs switching.

### Commercial Version (Continued) SOIC and PLCC AC Electrical Characteristics

 $V_{EE} = -4.2V$  to  $-5.7V$ ,  $V_{CC} = V_{CCA} = GND$ 

| Symbol     | Parameter   | $T_C = 0^\circ C$ |      | $T_C = +25^\circ C$ |      | $T_C = +85^\circ C$ |      | Units | Conditions               |
|------------|---|-------------------|------|---------------------|------|---------------------|------|-------|--------------------------|
|            |   | Min               | Max  | Min                 | Max  | Min                 | Max  |       |                          |
| $t_{PLH}$  | Propagation Delay   | 0.50              | 1.05 | 0.50                | 1.05 | 0.50                | 1.15 | ns    | Figures 1, 2<br>(Note 5) |
| $t_{PHL}$  | Data to Output  |                   |      |                     |      |                     |      |       |                          |
| $t_{PLH}$  | Propagation Delay   | 0.70              | 1.80 | 0.70                | 1.80 | 0.80                | 1.90 | ns    |                          |
| $t_{PHL}$  | Enable to Output  |                   |      |                     |      |                     |      |       |                          |
| $t_{TLH}$  | Transition Time   | 0.40              | 1.10 | 0.40                | 1.10 | 0.40                | 1.10 | ns    | Figures 1, 2             |
| $t_{THL}$  | 20% to 80%, 80% to 20%  |                   |      |                     |      |                     |      |       |                          |
| $t_{OSHL}$ | Maximum Skew Common Edge<br>Output-to-Output Variation<br>Data to Output Path     |                   | 250  |                     | 250  |                     | 250  | ps    | PLCC Only<br>(Note 6)    |
| $t_{OSHL}$ | Maximum Skew Common Edge<br>Output-to-Output Variation<br>Enable to Output Path   |                   | 310  |                     | 310  |                     | 310  |       |                          |
| $t_{OSLH}$ | Maximum Skew Common Edge<br>Output-to-Output Variation<br>Data to Output Path     |                   | 200  |                     | 200  |                     | 200  | ps    | PLCC Only<br>(Note 6)    |
| $t_{OSLH}$ | Maximum Skew Common Edge<br>Output-to-Output Variation<br>Enable to Output Path   |                   | 330  |                     | 330  |                     | 330  |       |                          |
| $t_{OST}$  | Maximum Skew Opposite Edge<br>Output-to-Output Variation<br>Data to Output Path   |                   | 250  |                     | 250  |                     | 250  | ps    | PLCC Only<br>(Note 6)    |
| $t_{OST}$  | Maximum Skew Opposite Edge<br>Output-to-Output Variation<br>Enable to Output Path |                   | 330  |                     | 330  |                     | 330  |       |                          |
| $t_{PS}$   | Maximum Skew<br>Pin (Signal) Transition Variation<br>Data to Output Path          |                   | 200  |                     | 200  |                     | 200  | ps    | PLCC Only<br>(Note 6)    |
| $t_{PS}$   | Maximum Skew<br>Pin (Signal) Transition Variation<br>Enable to Output Path        |                   | 280  |                     | 280  |                     | 280  |       |                          |

**Note 5:** The propagation delay specified is for single output switching. Delays may vary up to 100 ps with multiple outputs switching.

**Note 6:** Output-to-Output Skew is defined as the absolute value of the difference between the actual propagation delay for any outputs within the same packaged device. The specifications apply to any outputs switching in the same direction either HIGH-to-LOW ( $t_{OSHL}$ ), or LOW-to-HIGH ( $t_{OSLH}$ ), or in opposite directions both HL and LH ( $t_{OST}$ ). Parameters  $t_{OST}$  and  $t_{PS}$  guaranteed by design.

**Industrial Version****PLCC DC Electrical Characteristics** (Note 7)
 $V_{EE} = -4.2V$  to  $-5.7V$ ,  $V_{CC} = V_{CCA} = GND$ ,  $T_C = -40^{\circ}C$  to  $+85^{\circ}C$ 

| Symbol    | Parameter            | $T_C = -40^{\circ}C$ |       | $T_C = 0^{\circ}C$ to $+85^{\circ}C$ |       | Units | Conditions                                 |                                |
|-----------|----------------------|----------------------|-------|--------------------------------------|-------|-------|--|--------------------------------|
|           |                      | Min                  | Max   | Min                                  | Max   |       |  |                                |
| $V_{OH}$  | Output HIGH Voltage  | -1085                | -870  | -1025                                | -870  | mV    | $V_{IN} = V_{IH(Max)}$<br>or $V_{IL(Min)}$ | Loading with<br>50Ω to $-2.0V$ |
| $V_{OL}$  | Output LOW Voltage   | -1830                | -1575 | -1830                                | -1620 |       |  |                                |
| $V_{OHC}$ | Output HIGH Voltage  | -1095                |       | -1035                                |       | mV    | $V_{IN} = V_{IH(Min)}$<br>or $V_{IL(Max)}$ | Loading with<br>50Ω to $-2.0V$ |
| $V_{OLC}$ | Output LOW Voltage   |                      | -1565 |                                      | -1610 |       |  |                                |
| $V_{IH}$  | Input HIGH Voltage   | -1170                | -870  | -1165                                | -870  | mV    | Guaranteed HIGH Signal for ALL Inputs      |                                |
| $V_{IL}$  | Input LOW Voltage    | -1830                | -1480 | -1830                                | -1475 | mV    | Guaranteed LOW Signal for ALL Inputs       |                                |
| $I_{IL}$  | Input LOW Current    | 0.05                 |       | 0.05                                 |       | μA    | $V_{IN} = V_{IL(Min)}$                     |                                |
| $I_{IH}$  | Input HIGH Current   |                      | 300   |                                      | 240   | μA    | $V_{IN} = V_{IH(Max)}$                     |                                |
| $I_{EE}$  | Power Supply Current | -45                  | -20   | -45                                  | -20   | mA    | Inputs OPEN                                |                                |

**Note 7:** The specified limits represent the "worst case" value for the parameter. Since these values normally occur at the temperature extremes, additional noise immunity and guardbanding can be achieved by decreasing the allowable system operating ranges. Conditions for testing shown in the tables are chosen to guarantee operation under the "worst case" conditions.

**PLCC AC Electrical Characteristics**
 $V_{EE} = -4.2V$  to  $-5.7V$ ,  $V_{CC} = V_{CCA} = GND$ 

| Symbol    | Parameter                                 | $T_C = -40^{\circ}C$ |      | $T_C = +25^{\circ}C$ |      | $T_C = +85^{\circ}C$ |      | Units | Conditions               |
|-----------|---|----------------------|------|----------------------|------|----------------------|------|-------|--------------------------|
|           |   | Min                  | Max  | Min                  | Max  | Min                  | Max  |       |                          |
| $t_{PLH}$ | Propagation Delay                         | 0.40                 | 1.05 | 0.50                 | 1.05 | 0.50                 | 1.15 | ns    | Figures 1, 2<br>(Note 8) |
| $t_{PHL}$ | Data to Output                            |                      |      |                      |      |                      |      |       |                          |
| $t_{PLH}$ | Propagation Delay                         | 0.70                 | 1.80 | 0.70                 | 1.80 | 0.80                 | 1.90 | ns    |                          |
| $t_{PHL}$ | Enable to Output                          |                      |      |                      |      |                      |      |       |                          |
| $t_{TLH}$ | Transition Time<br>20% to 80%, 80% to 20% | 0.30                 | 1.10 | 0.40                 | 1.10 | 0.40                 | 1.10 | ns    | Figures 1, 2             |
| $t_{THL}$ |   |                      |      |                      |      |                      |      |       |                          |

**Note 8:** The propagation delay specified is for single output switching. Delays may vary up to 200 ps with multiple outputs switching.

### Test Circuitry

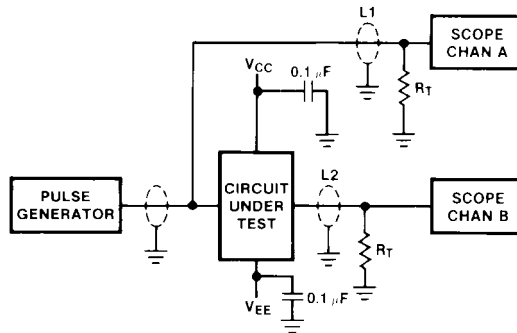

- Notes:**  
 $V_{CC}, V_{CCA} = +2V, V_{EE} = -2.5V$   
 L1 and L2 = equal length 50Ω impedance lines  
 $R_T = 50\Omega$  terminator internal to scope  
 Decoupling 0.1 μF from GND to  $V_{CC}$  and  $V_{EE}$   
 All unused outputs are loaded with 50Ω to GND  
 $C_L$  = Fixture and stray capacitance  $\leq 3$  pF

FIGURE 1. AC Test Circuit

### Switching Waveforms

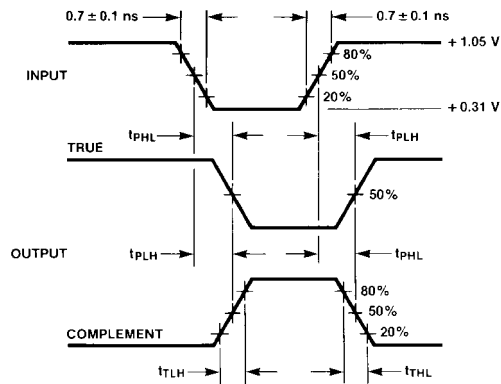
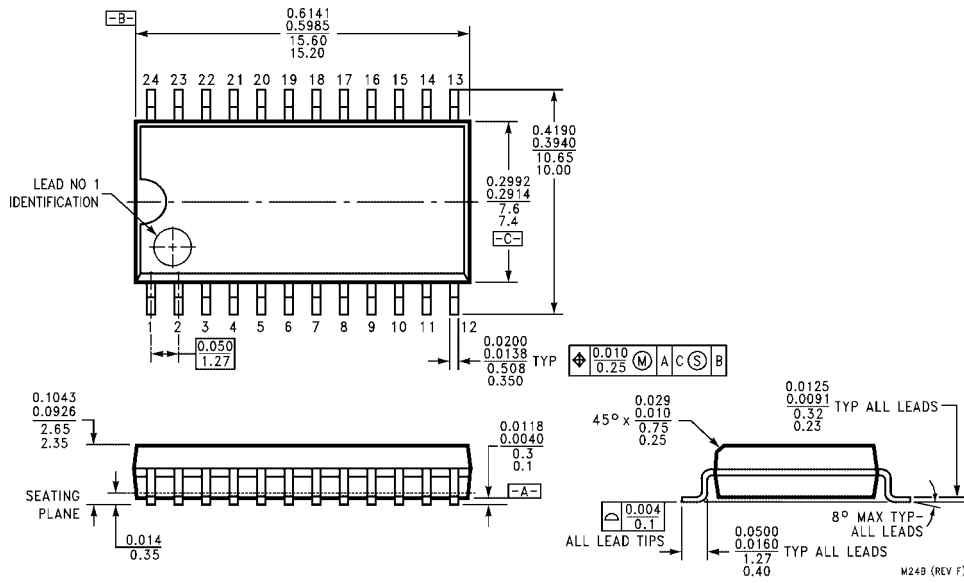
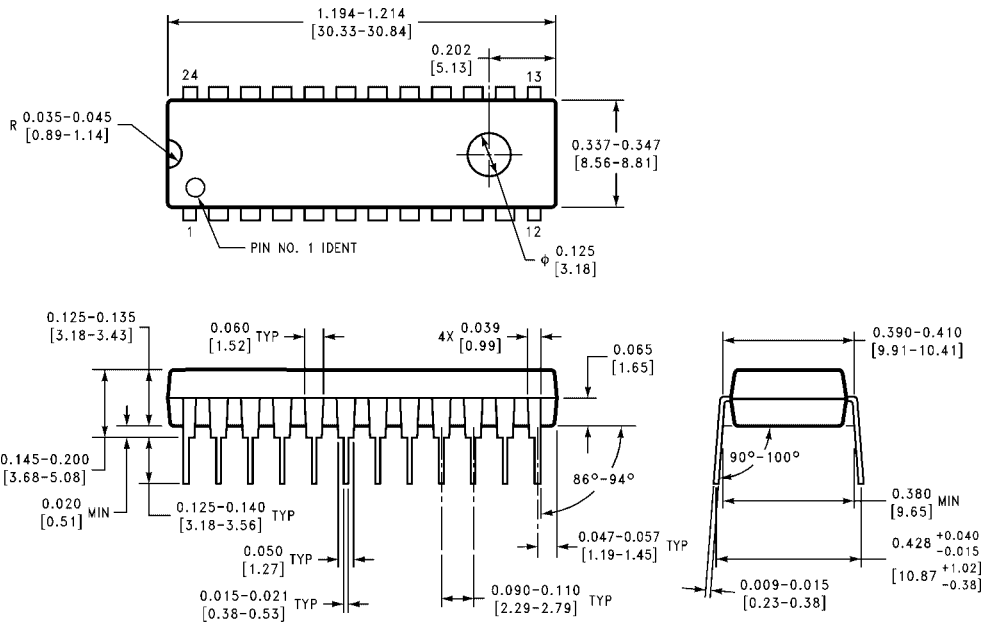

FIGURE 2. Propagation Delay and Transition Times

**Physical Dimensions** inches (millimeters) unless otherwise noted



**24-Lead Small Outline Integrated Circuit (SOIC), JEDEC MS-013, 0.300 Wide  
Package Number M24B**



**24-Lead Plastic Dual-In-Line Package (PDIP), JEDEC MS-010, 0.400 Wide  
Package Number N24E**

**Physical Dimensions** inches (millimeters) unless otherwise noted (Continued)

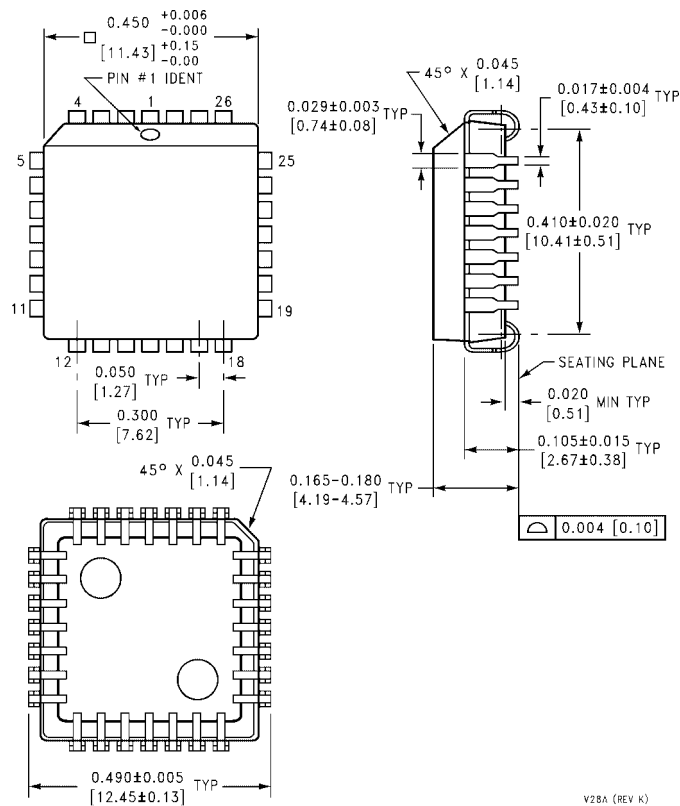

**28-Lead Plastic Lead Chip Carrier (PLCC), JEDEC MO-047, 0.450 Square Package Number V28A**

Fairchild does not assume any responsibility for use of any circuitry described, no circuit patent licenses are implied and Fairchild reserves the right at any time without notice to change said circuitry and specifications.

**LIFE SUPPORT POLICY**

FAIRCHILD'S PRODUCTS ARE NOT AUTHORIZED FOR USE AS CRITICAL COMPONENTS IN LIFE SUPPORT DEVICES OR SYSTEMS WITHOUT THE EXPRESS WRITTEN APPROVAL OF THE PRESIDENT OF FAIRCHILD SEMICONDUCTOR CORPORATION. As used herein:

1. Life support devices or systems are devices or systems which, (a) are intended for surgical implant into the body, or (b) support or sustain life, and (c) whose failure to perform when properly used in accordance with instructions for use provided in the labeling, can be reasonably expected to result in a significant injury to the user.
2. A critical component in any component of a life support device or system whose failure to perform can be reasonably expected to cause the failure of the life support device or system, or to affect its safety or effectiveness.

[www.fairchildsemi.com](http://www.fairchildsemi.com)