

# IRFI4020H-117P

## Features

- Integrated half-bridge package
- Reduces the part count by half
- Facilitates better PCB layout
- Key parameters optimized for Class-D audio amplifier applications
- Low  $R_{DS(ON)}$  for improved efficiency
- Low  $Q_g$  and  $Q_{sw}$  for better THD and improved efficiency
- Low  $Q_{rr}$  for better THD and lower EMI
- Can delivery up to 300W per channel into 8Ω load in half-bridge configuration amplifier
- Lead-free package

Key Parameters ⑤		
$V_{DS}$	200	V
$R_{DS(ON)}$ typ. @ 10V	80	mΩ
$Q_g$ typ.	19	nC
$Q_{sw}$ typ.	6.8	nC
$R_{G(int)}$ typ.	3.0	Ω
$T_J$ max	150	°C

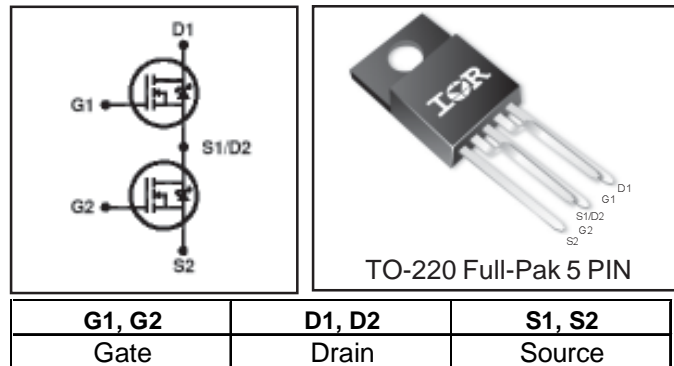

## Description

This Digital Audio MosFET Half-Bridge is specifically designed for Class D audio amplifier applications. It consists of two power MosFET switches connected in half-bridge configuration. The latest process is used to achieve low on-resistance per silicon area. Furthermore, Gate charge, body-diode reverse recovery, and internal Gate resistance are optimized to improve key Class D audio amplifier performance factors such as efficiency, THD and EMI. These combine to make this Half-Bridge a highly efficient, robust and reliable device for Class D audio amplifier applications.

## Absolute Maximum Ratings ⑤

	Parameter	Max.	Units
$V_{DS}$	Drain-to-Source Voltage	200	V
$V_{GS}$	Gate-to-Source Voltage	±20	
$I_D$ @ $T_C = 25^\circ\text{C}$	Continuous Drain Current, $V_{GS}$ @ 10V	9.1	A
$I_D$ @ $T_C = 100^\circ\text{C}$	Continuous Drain Current, $V_{GS}$ @ 10V	5.7	
$I_{DM}$	Pulsed Drain Current ①	36	
$P_D$ @ $T_C = 25^\circ\text{C}$	Power Dissipation ④	21	W
$P_D$ @ $T_C = 100^\circ\text{C}$	Power Dissipation ④	8.5	
	Linear Derating Factor	0.17	W/°C
$E_{AS}$	Single Pulse Avalanche Energy②	130	mJ
$T_J$	Operating Junction and	-55 to + 150	°C
$T_{STG}$	Storage Temperature Range		
	Soldering Temperature, for 10 seconds (1.6mm from case)	300	
	Mounting torque, 6-32 or M3 screw	10lb·in (1.1N·m)	

## Thermal Resistance ⑤

	Parameter	Typ.	Max.	Units
$R_{\theta JC}$	Junction-to-Case ④	—	5.9	°C/W
$R_{\theta JA}$	Junction-to-Ambient (free air)	—	65	

## Electrical Characteristics @ $T_J = 25^\circ\text{C}$ (unless otherwise specified) ⑤

	Parameter	Min.	Typ.	Max.	Units	Conditions
$BV_{DSS}$	Drain-to-Source Breakdown Voltage	200	—	—	V	$V_{GS} = 0V, I_D = 250\mu A$
$\Delta BV_{DSS}/\Delta T_J$	Breakdown Voltage Temp. Coefficient	—	24	—	mV/°C	Reference to $25^\circ\text{C}, I_D = 1mA$
$R_{DS(on)}$	Static Drain-to-Source On-Resistance	—	80	100	mΩ	$V_{GS} = 10V, I_D = 5.5A$ ③
$V_{GS(th)}$	Gate Threshold Voltage	3.0	—	4.9	V	$V_{DS} = V_{GS}, I_D = 100\mu A$
$\Delta V_{GS(th)}/\Delta T_J$	Gate Threshold Voltage Coefficient	—	-12	—	mV/°C	
$I_{DSS}$	Drain-to-Source Leakage Current	—	—	20	μA	$V_{DS} = 200V, V_{GS} = 0V$
		—	—	250		$V_{DS} = 200V, V_{GS} = 0V, T_J = 125^\circ\text{C}$
$I_{GSS}$	Gate-to-Source Forward Leakage	—	—	100	nA	$V_{GS} = 20V$
	Gate-to-Source Reverse Leakage	—	—	-100		$V_{GS} = -20V$
$g_{fs}$	Forward Transconductance	11	—	—	S	$V_{DS} = 50V, I_D = 5.5A$
$Q_g$	Total Gate Charge	—	19	29	nC	$V_{DS} = 100V$ $V_{GS} = 10V$ $I_D = 5.5A$ See Fig. 6 and 15
$Q_{gs1}$	Pre-V <sub>th</sub> Gate-to-Source Charge	—	4.9	—		
$Q_{gs2}$	Post-V <sub>th</sub> Gate-to-Source Charge	—	0.95	—		
$Q_{gd}$	Gate-to-Drain Charge	—	5.8	—		
$Q_{godr}$	Gate Charge Overdrive	—	7.4	—		
$Q_{sw}$	Switch Charge ( $Q_{gs2} + Q_{gd}$ )	—	6.8	—		
$R_{G(int)}$	Internal Gate Resistance	—	3.0	—	Ω	
$t_{d(on)}$	Turn-On Delay Time	—	8.4	—	ns	$V_{DD} = 100V, V_{GS} = 10V$ ③ $I_D = 5.5A$ $R_G = 2.4\Omega$
$t_r$	Rise Time	—	8.0	—		
$t_{d(off)}$	Turn-Off Delay Time	—	18	—		
$t_f$	Fall Time	—	4.0	—		
$C_{iss}$	Input Capacitance	—	1240	—	pF	$V_{GS} = 0V$ $V_{DS} = 25V$ $f = 1.0MHz,$ See Fig. 5 $V_{GS} = 0V, V_{DS} = 0V$ to $160V$
$C_{oss}$	Output Capacitance	—	130	—		
$C_{riss}$	Reverse Transfer Capacitance	—	28	—		
$C_{oss\ eff.}$	Effective Output Capacitance	—	110	—		
$L_D$	Internal Drain Inductance	—	4.5	—	nH	Between lead, 6mm (0.25in.) from package and center of die contact
$L_S$	Internal Source Inductance	—	7.5	—		

## Diode Characteristics ⑤

	Parameter	Min.	Typ.	Max.	Units	Conditions
$I_S @ T_C = 25^\circ\text{C}$	Continuous Source Current (Body Diode)	—	—	9.1	A	MOSFET symbol showing the integral reverse p-n junction diode.
$I_{SM}$	Pulsed Source Current (Body Diode) ①	—	—	36		
$V_{SD}$	Diode Forward Voltage	—	—	1.3	V	$T_J = 25^\circ\text{C}, I_S = 5.5A, V_{GS} = 0V$ ③
$t_{rr}$	Reverse Recovery Time	—	76	110	ns	$T_J = 25^\circ\text{C}, I_F = 5.5A, V_{DD} = 160V$
$Q_{rr}$	Reverse Recovery Charge	—	230	350	nC	$di/dt = 100A/\mu s$ ③

### Notes:

- ① Repetitive rating; pulse width limited by max. junction temperature.
- ② Starting  $T_J = 25^\circ\text{C}, L = 8.6mH, R_G = 25\Omega, I_{AS} = 5.5A$ .
- ③ Pulse width  $\leq 400\mu s$ ; duty cycle  $\leq 2\%$ .
- ④  $R_{\theta}$  is measured at  $T_J$  of approximately  $90^\circ\text{C}$ .
- ⑤ Specifications refer to single MosFET.

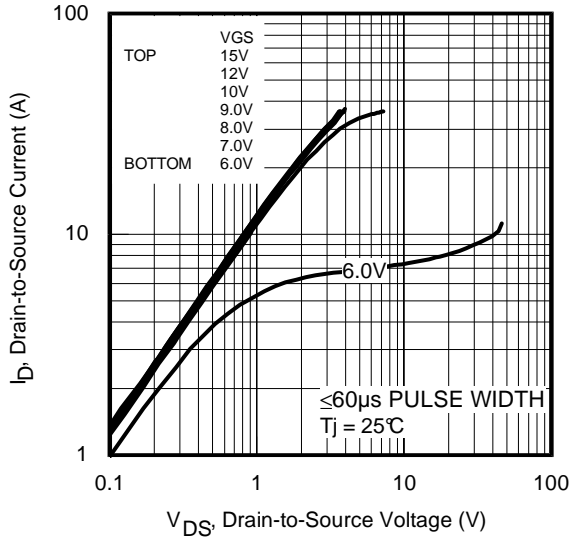

**Fig 1.** Typical Output Characteristics

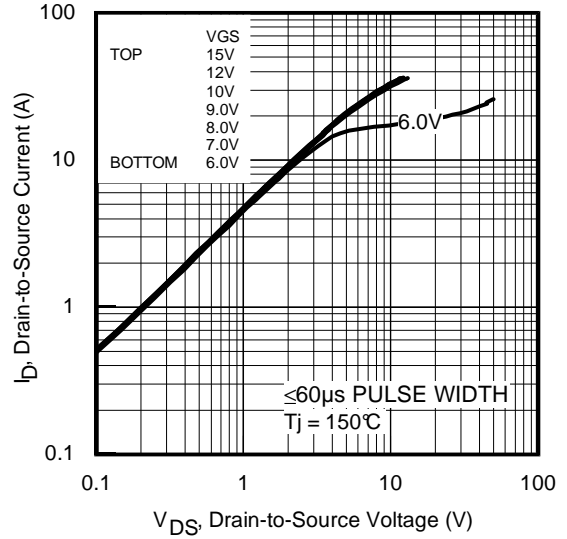

**Fig 2.** Typical Output Characteristics

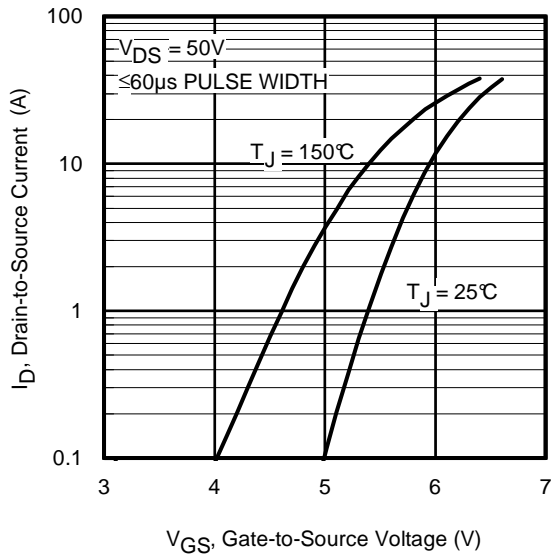

**Fig 3.** Typical Transfer Characteristics

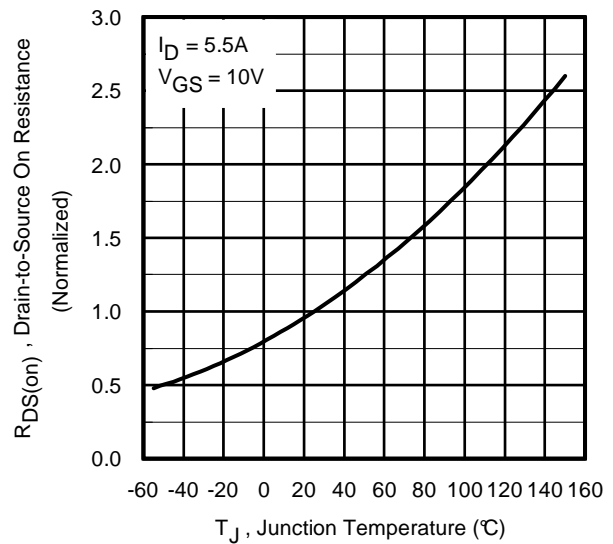

**Fig 4.** Normalized On-Resistance vs. Temperature

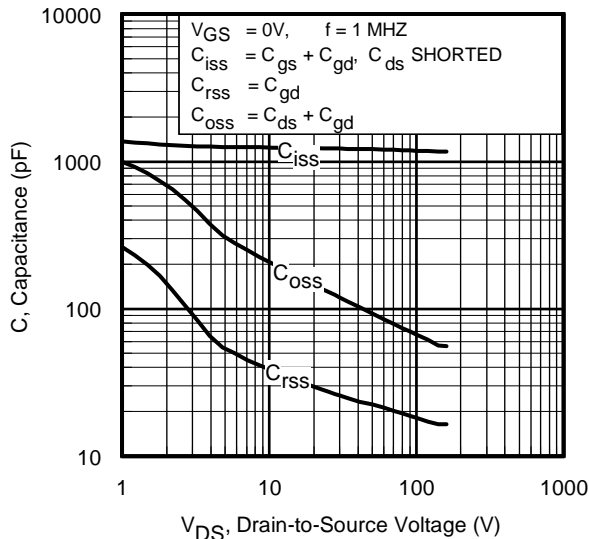

**Fig 5.** Typical Capacitance vs. Drain-to-Source Voltage  
[www.irf.com](http://www.irf.com)

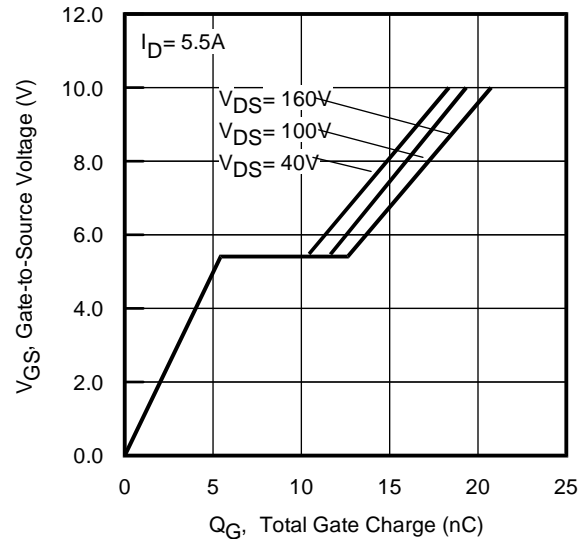

**Fig 6.** Typical Gate Charge vs. Gate-to-Source Voltage

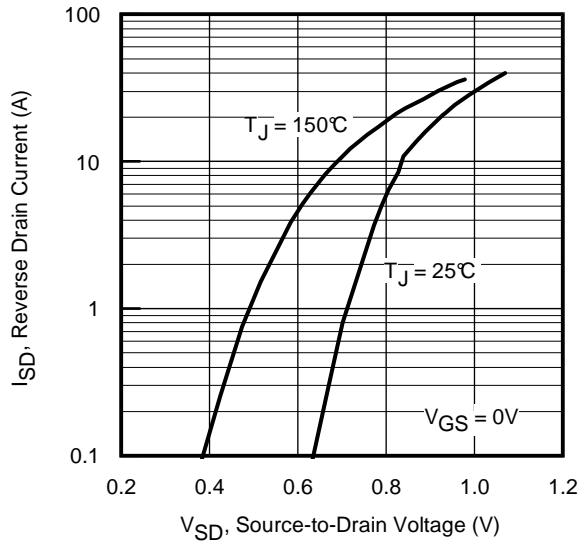

**Fig 7.** Typical Source-Drain Diode Forward Voltage

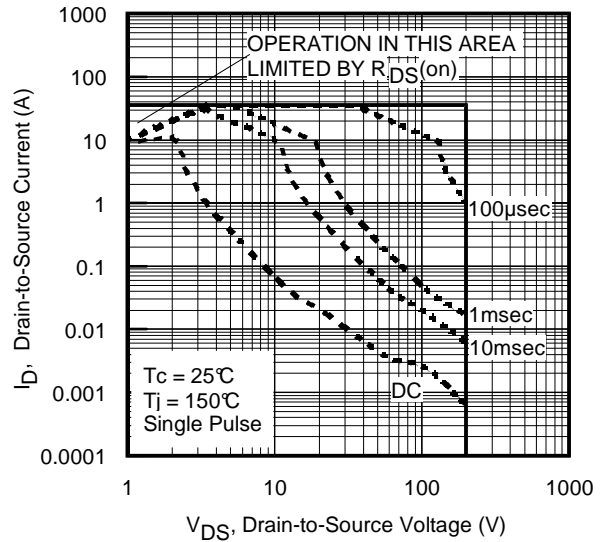

**Fig 8.** Maximum Safe Operating Area

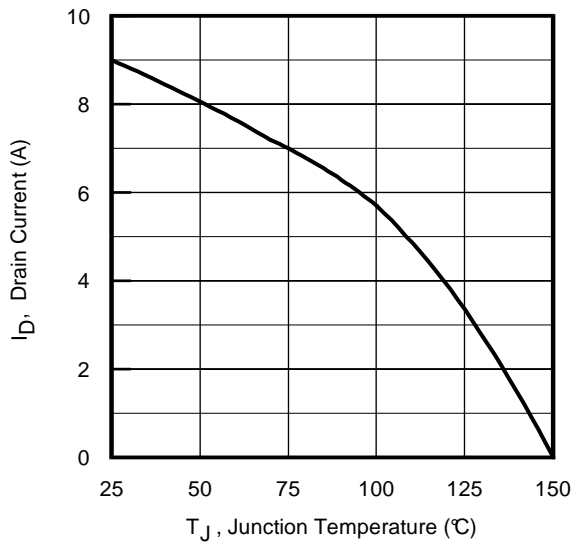

**Fig 9.** Maximum Drain Current vs. Junction Temperature

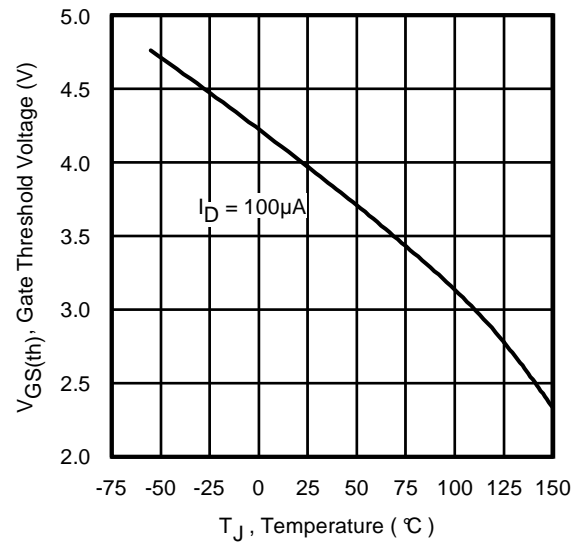

**Fig 10.** Threshold Voltage vs. Temperature

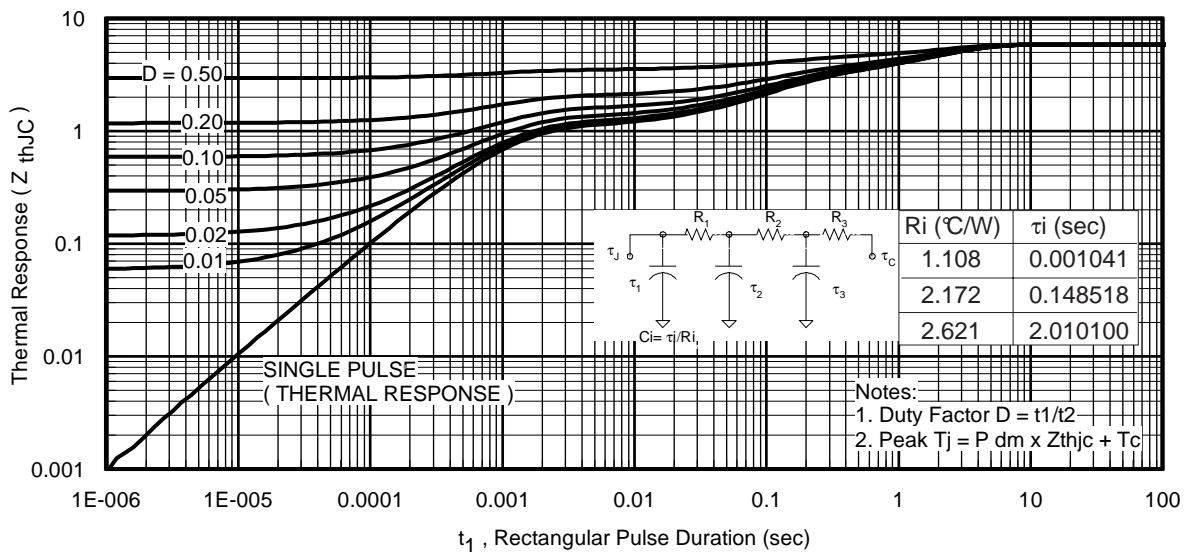

**Fig 11.** Maximum Effective Transient Thermal Impedance, Junction-to-Case

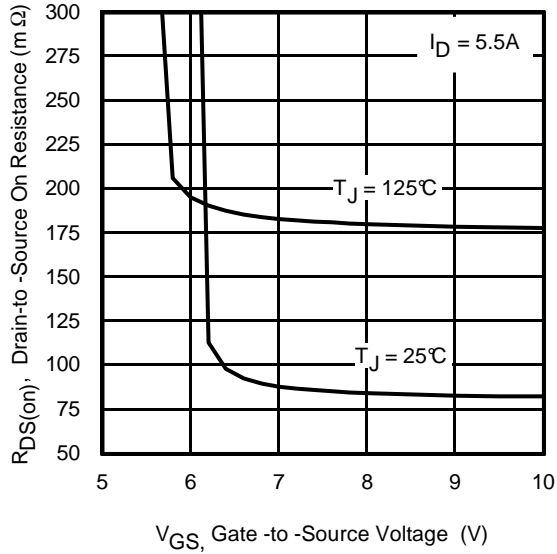

**Fig 12.** On-Resistance vs. Gate Voltage

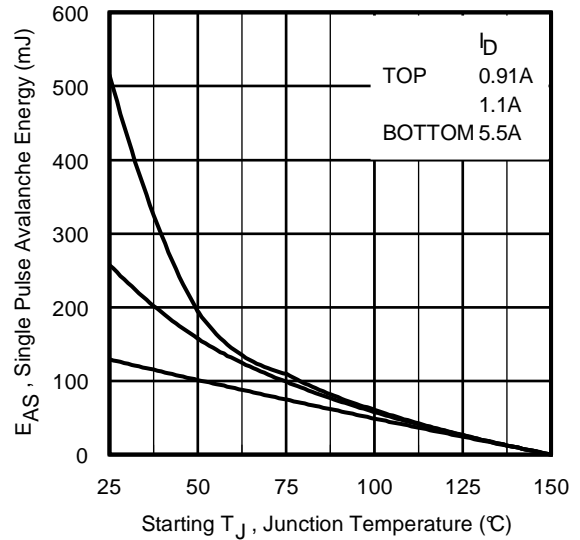

**Fig 13a.** Maximum Avalanche Energy vs. Drain Current

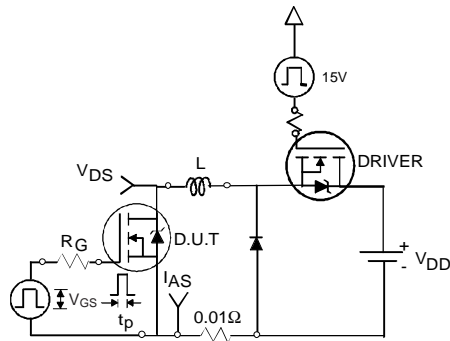

**Fig 13b.** Unclamped Inductive Test Circuit

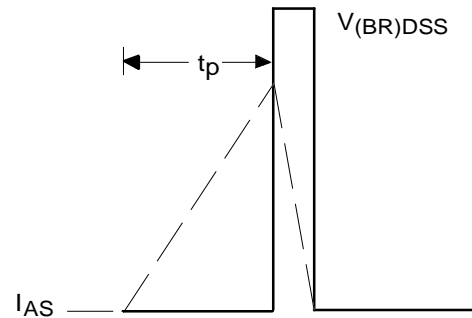

**Fig 13c.** Unclamped Inductive Waveforms

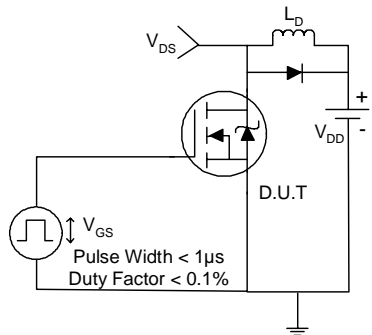

**Fig 14a.** Switching Time Test Circuit

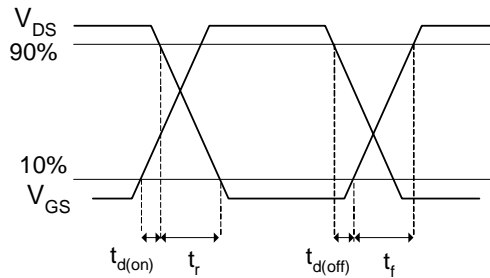

**Fig 14b.** Switching Time Waveforms

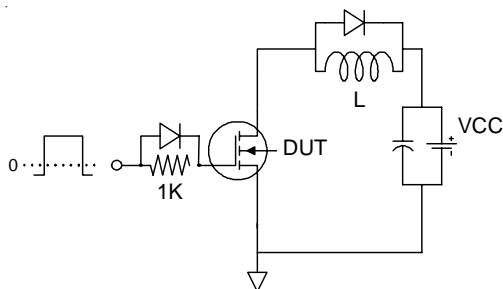

**Fig 15a.** Gate Charge Test Circuit

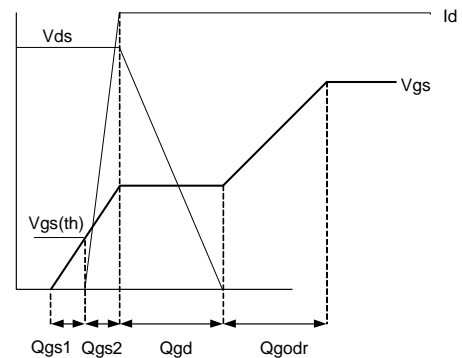
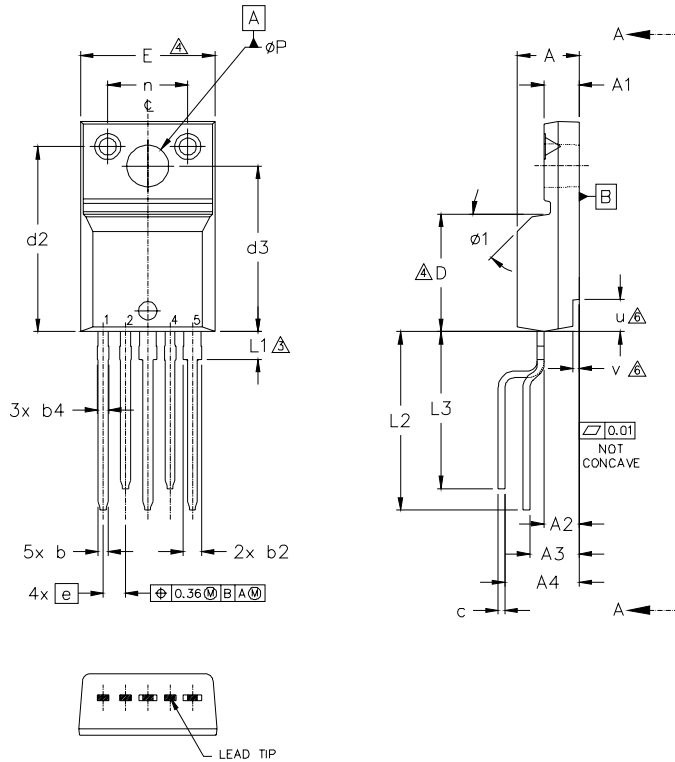

**Fig 15b** Gate Charge Waveform

# IRFI4020H-117P

## TO-220 Full-Pak 5-Pin Package Outline, Lead-Form Option 117

(Dimensions are shown in millimeters (inches))



**NOTES:**

- 1.0 DIMENSIONING AND TOLERANCING AS PER ASME Y14.5 M- 1994.
- 2.0 DIMENSIONS ARE SHOWN IN MILLIMETERS [INCHES].
- 3.0 LEAD DIMENSION AND FINISH UNCONTROLLED IN L1.
- 4.0 DIMENSION D & E DO NOT INCLUDE MOLD FLASH. MOLD FLASH SHALL NOT EXCEED .005" (0.127) PER SIDE. THESE DIMENSIONS ARE MEASURED AT THE OUTER MOST EXTREMES OF THE PLASTIC BODY.
- 5.0 DIMENSION b1, b3, b5 & c1 APPLY TO BASE METAL ONLY.
- 6.0 STEP OPTIONAL ON PLASTIC BODY DEFINED BY DIMENSIONS u & v.
- 7.0 CONTROLLING DIMENSION : INCHES.

SYMBOL	DIMENSIONS				NOTES
	MILLIMETERS		INCHES		
	MIN.	MAX.	MIN.	MAX.	
A	4.57	4.83	.180	.190	
A1	2.57	2.83	.101	.111	
A2	2.51	2.85	.099	.112	
A3	3.73	4.24	.147	.167	
A4	5.79	6.29	.228	.248	
b	0.61	0.95	0.24	.037	5
b1	0.56	0.90	.022	0.35	
b2	1.13	1.48	0.44	.058	5
b3	1.08	1.43	0.42	.056	
b4	0.76	1.06	.030	.042	5
b5	0.71	1.01	.028	.040	
c	0.33	0.63	.013	.025	
c1	0.28	0.58	.011	.023	5
D	8.65	9.80	.341	.386	4
d1	15.80	16.12	.622	.635	
d2	13.97	14.22	.550	.560	
d3	12.30	12.92	.484	.509	
E	9.63	10.63	.379	.419	4

SYMBOL	DIMENSIONS				NOTES
	MILLIMETERS		INCHES		
	MIN.	MAX.	MIN.	MAX.	
e	1.70	BSC	.067	BSC	
L	13.20	13.73	.520	.541	3
L1	1.91	2.31	.075	.091	
L2	12.7	13.46	.500	.530	
L3	10.92	11.68	.430	.460	
n	6.05	6.15	.238	.242	
phi P	3.05	3.45	.120	.136	
u	2.40	2.50	.094	.098	6
v	0.40	0.50	.016	.020	
phi 1	-	45°	-	45°	

**LEAD ASSIGNMENTS**

- 1 - SOURCE 2
- 2 - GATE 2
- 3 - DRAIN 2 / SOURCE 1
- 4 - GATE 1
- 5 - DRAIN 1

## TO-220 Full-Pak 5-Pin Part Marking Information

EXAMPLE: THIS IS AN IRFI4020H WITH LOT CODE 8024 ASSEMBLED ON WW02.2000 IN THE ASSEMBLY LINE "L"

Note: "P" in assembly line position indicates "Lead Free"

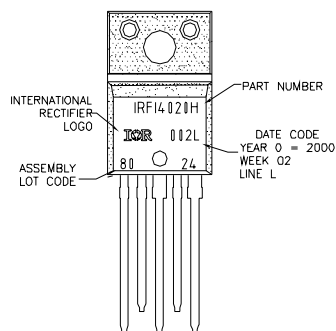

OR

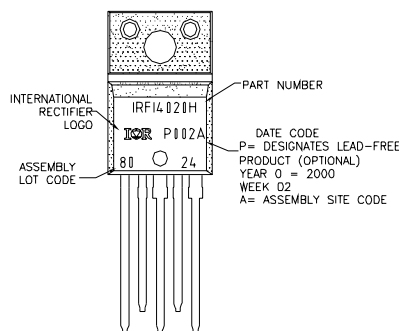

**TO-220AB Full-Pak 5-Pin package is not recommended for Surface Mount Application.**

Data and specifications subject to change without notice. This product has been designed for the Consumer market. Qualification Standards can be found on IR's Web site.

Note: For the most current drawings please refer to the IR website at:  
<http://www.irf.com/package/>