

# IRF6723M2DTRPbF

# IRF6723M2DTR1PbF

DirectFET™ Power MOSFET ②

## Applications

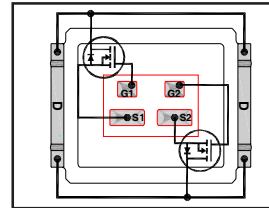
- Dual Common Drain Control MOSFETs for Multiphase DC-DC Converters

## Features

- Replaces Two Discrete MOSFETs
- Optimized for High Frequency Switching
- Low Profile (<0.7 mm)
- Dual Sided Cooling Compatible
- Ultra Low Package Inductance
- Compatible with existing Surface Mount Techniques
- RoHS Compliant and Halogen Free
- 100% Rg tested

Typical values (unless otherwise specified)

$V_{DS}$	$V_{GS}$	$R_{DS(on)}$	$R_{DS(on)}$		
30V max	$\pm 20V$ max	5.2m $\Omega$ @ 10V	8.6m $\Omega$ @ 4.5V		
$Q_{g\ tot}$	$Q_{gd}$	$Q_{gs2}$	$Q_{rr}$	$Q_{oss}$	$V_{gs(th)}$
9.4nC	3.3nC	1.2nC	17nC	6.3nC	1.8V



Applicable DirectFET Outline and Substrate Outline ①

S1	S2	SB		M2	M4	<b>MA</b>	L4	L6	L8	
----	----	----	--	----	----	-----------	----	----	----	--

## Description

The IRF6723M2DPbF combines two MOSFET switches optimized for high side applications into a single medium can DirectFET package. The switches have low gate resistance and low charge along with ultra low package inductance providing significant reduction in switching losses. The reduced losses make this product ideal for high efficiency multiphase DC-DC converters that power the latest generation of processors operating at higher frequencies.

The IRF6723M2DPbF combines the latest HEXFET® Power MOSFET Silicon technology with the advanced DirectFET™ packaging to achieve the highest power density for two MOSFETs in a package that has the footprint of a SO-8 and only 0.7 mm profile. The DirectFET package is compatible with existing layout geometries used in power applications, PCB assembly equipment and vapor phase, infra-red or convection soldering techniques, when application note AN-1035 is followed regarding the manufacturing methods and processes. The DirectFET package allows dual sided cooling to maximize thermal transfer in power systems, improving previous best thermal resistance by 80%.

## Absolute Maximum Ratings (each die operating consecutively)

	Parameter	Max.	Units
$V_{DS}$	Drain-to-Source Voltage	30	V
$V_{GS}$	Gate-to-Source Voltage	$\pm 20$	
$I_D @ T_A = 25^\circ C$	Continuous Drain Current, $V_{GS} @ 10V$ ③	15	A
$I_D @ T_A = 70^\circ C$	Continuous Drain Current, $V_{GS} @ 10V$ ③	13	
$I_D @ T_C = 25^\circ C$	Continuous Drain Current, $V_{GS} @ 10V$ ④	47	
$I_{DM}$	Pulsed Drain Current ⑤	130	
$E_{AS}$	Single Pulse Avalanche Energy ⑥	71	mJ
$I_{AR}$	Avalanche Current ⑤	12	A

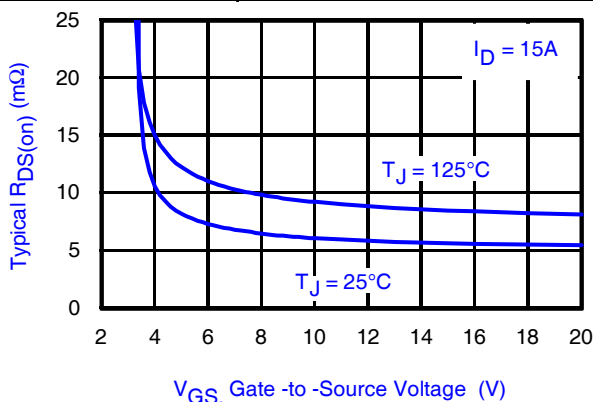


Fig 1. Typical On-Resistance vs. Gate Voltage

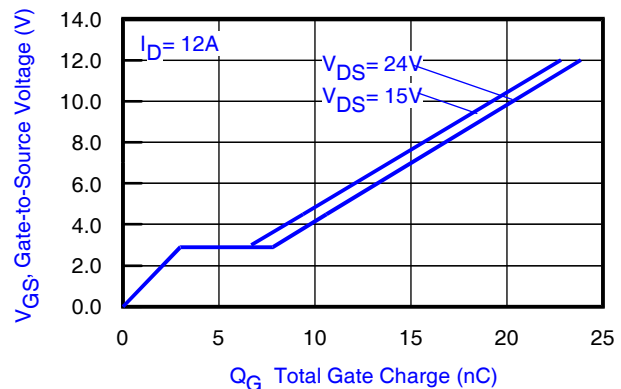


Fig 2. Typical Total Gate Charge vs. Gate-to-Source Voltage

Notes:

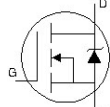
- ① Click on this section to link to the appropriate technical paper.
- ② Click on this section to link to the DirectFET Website.
- ③ Surface mounted on 1 in. square Cu board, steady state.

- ④  $T_C$  measured with thermocouple mounted to top (Drain) of part.
- ⑤ Repetitive rating; pulse width limited by max. junction temperature.
- ⑥ Starting  $T_J = 25^\circ C$ ,  $L = 0.99mH$ ,  $R_G = 25\Omega$ ,  $I_{AS} = 12A$ .

### Static @ $T_J = 25^\circ\text{C}$ (each die unless otherwise specified)

	Parameter	Min.	Typ.	Max.	Units	Conditions
$BV_{DSS}$	Drain-to-Source Breakdown Voltage	30	—	—	V	$V_{GS} = 0V, I_D = 250\mu A$
$\Delta BV_{DSS}/\Delta T_J$	Breakdown Voltage Temp. Coefficient	—	20	—	mV/°C	Reference to $25^\circ\text{C}, I_D = 1\text{mA}$
$R_{DS(on)}$	Static Drain-to-Source On-Resistance	—	5.2	6.6	mΩ	$V_{GS} = 10V, I_D = 15A$ ⑦
		—	8.6	11.3		$V_{GS} = 4.5V, I_D = 12A$ ⑦
$V_{GS(th)}$	Gate Threshold Voltage	1.35	1.8	2.35	V	$V_{DS} = V_{GS}, I_D = 25\mu A$
$\Delta V_{GS(th)}/\Delta T_J$	Gate Threshold Voltage Coefficient	—	-7.2	—	mV/°C	
$I_{DSS}$	Drain-to-Source Leakage Current	—	—	1.0	μA	$V_{DS} = 24V, V_{GS} = 0V$
		—	—	150		$V_{DS} = 24V, V_{GS} = 0V, T_J = 125^\circ\text{C}$
$I_{GSS}$	Gate-to-Source Forward Leakage	—	—	100	nA	$V_{GS} = 20V$
	Gate-to-Source Reverse Leakage	—	—	-100		$V_{GS} = -20V$
$g_{fs}$	Forward Transconductance	34	—	—	S	$V_{DS} = 15V, I_D = 12A$
$Q_g$	Total Gate Charge	—	9.4	14	nC	$V_{DS} = 15V$ $V_{GS} = 4.5V$ $I_D = 12A$ See Fig. 2
$Q_{gs1}$	Pre-Vth Gate-to-Source Charge	—	2.2	—		
$Q_{gs2}$	Post-Vth Gate-to-Source Charge	—	1.2	—		
$Q_{gd}$	Gate-to-Drain Charge	—	3.3	—		
$Q_{godr}$	Gate Charge Overdrive	—	2.7	—		
$Q_{sw}$	Switch Charge ( $Q_{gs2} + Q_{gd}$ )	—	4.5	—		
$Q_{oss}$	Output Charge	—	6.3	—	nC	$V_{DS} = 16V, V_{GS} = 0V$
$R_G$	Gate Resistance	—	0.4	—	Ω	
$t_{d(on)}$	Turn-On Delay Time	—	14	—	ns	$V_{DD} = 15V, V_{GS} = 4.5V$ ⑦ $I_D = 12A$ $R_G = 6.8\Omega$
$t_r$	Rise Time	—	41	—		
$t_{d(off)}$	Turn-Off Delay Time	—	15	—		
$t_f$	Fall Time	—	20	—		
$C_{iss}$	Input Capacitance	—	1380	—	pF	$V_{GS} = 0V$ $V_{DS} = 15V$ $f = 1.0\text{MHz}$
$C_{oss}$	Output Capacitance	—	290	—		
$C_{rss}$	Reverse Transfer Capacitance	—	120	—		

### Diode Characteristics

	Parameter	Min.	Typ.	Max.	Units	Conditions
$I_S$	Continuous Source Current (Body Diode)	—	—	32	A	MOSFET symbol showing the integral reverse p-n junction diode. 
$I_{SM}$	Pulsed Source Current (Body Diode) ⑤	—	—	130		
$V_{SD}$	Diode Forward Voltage	—	—	1.0	V	$T_J = 25^\circ\text{C}, I_S = 12A, V_{GS} = 0V$ ⑦
$t_{rr}$	Reverse Recovery Time	—	16	24	ns	$T_J = 25^\circ\text{C}, I_F = 12A$
$Q_{rr}$	Reverse Recovery Charge	—	17	26	nC	$di/dt = 370A/\mu s$ ⑦

#### Notes:

- ⑤ Repetitive rating; pulse width limited by max. junction temperature.
- ⑦ Pulse width  $\leq 400\mu s$ ; duty cycle  $\leq 2\%$ .

**Absolute Maximum Ratings (each die operating consecutively)**

	Parameter	Max.	Units
$P_D @ T_A = 25^\circ\text{C}$	Power Dissipation ③	2.7	W
$P_D @ T_A = 70^\circ\text{C}$	Power Dissipation ③	1.9	
$P_D @ T_C = 25^\circ\text{C}$	Power Dissipation ④	25	
$T_P$	Peak Soldering Temperature	270	$^\circ\text{C}$
$T_J$	Operating Junction and	-55 to + 175	
$T_{STG}$	Storage Temperature Range		

**Thermal Resistance (each die operating consecutively)**

	Parameter	Typ.	Max.	Units
$R_{\theta JA}$	Junction-to-Ambient ③⑩	—	56	$^\circ\text{C}/\text{W}$
$R_{\theta JA}$	Junction-to-Ambient ⑧⑩	12.5	—	
$R_{\theta JA}$	Junction-to-Ambient ⑨⑩	20	—	
$R_{\theta JC}$	Junction-to-Case ④⑩	—	5.9	
$R_{\theta J-PCB}$	Junction-to-PCB Mounted	1.0	—	
	Linear Derating Factor ③	0.018		$\text{W}/^\circ\text{C}$

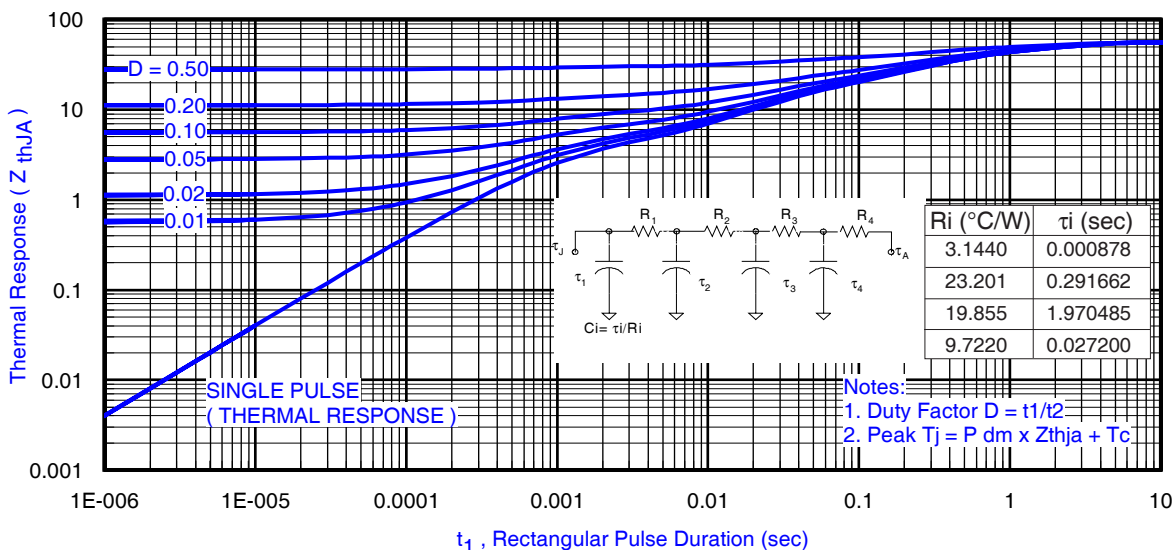
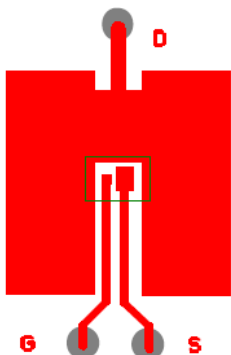


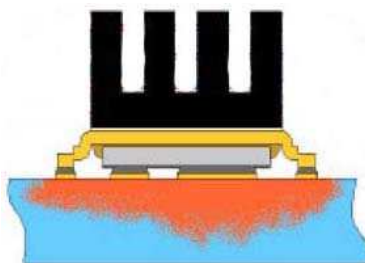
Fig 3. Maximum Effective Transient Thermal Impedance, Junction-to-Ambient ①

**Notes:**

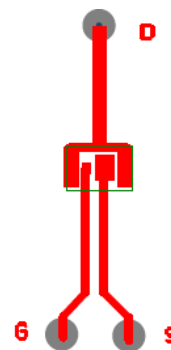
- ③ Surface mounted on 1 in. square Cu board, steady state.
- ④  $T_C$  measured with thermocouple incontact with top (Drain) of part.
- ⑤ Used double sided cooling, mounting pad with large heatsink.
- ⑥ Mounted on minimum footprint full size board with metalized back and with small clip heatsink.
- ⑦  $R_{\theta}$  is measured at  $T_J$  of approximately  $90^\circ\text{C}$ .

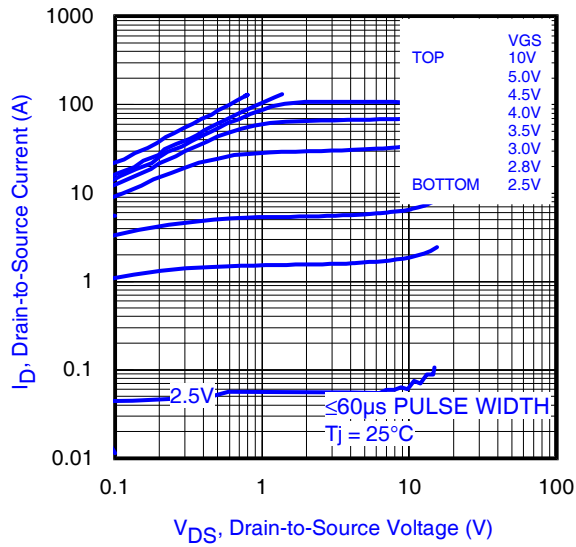


③ Surface mounted on 1 in. square Cu board (still air).

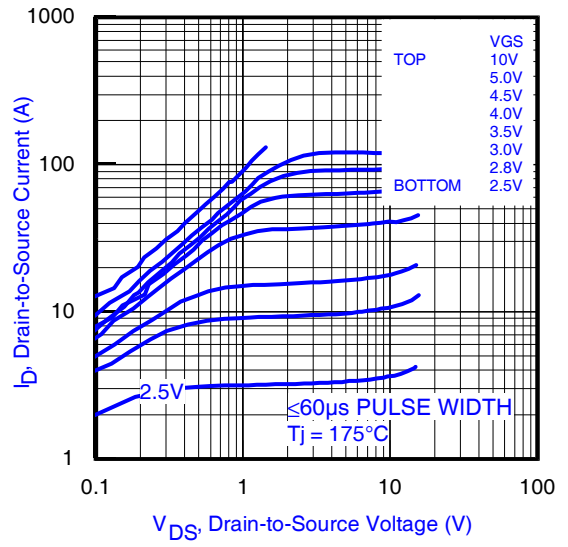


⑥ Mounted on minimum footprint full size board with metalized back and with small clip heatsink. (still air)

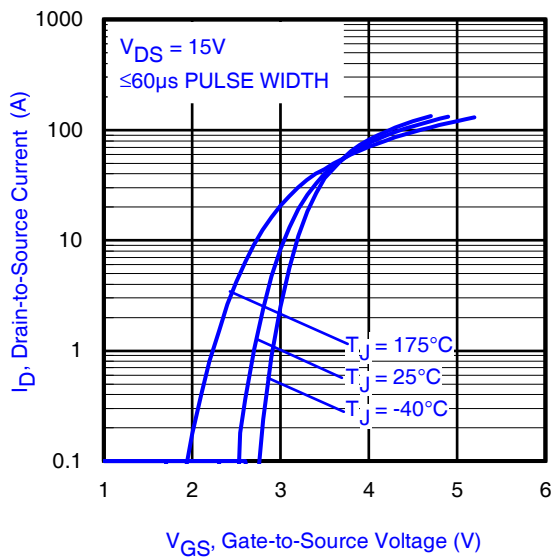




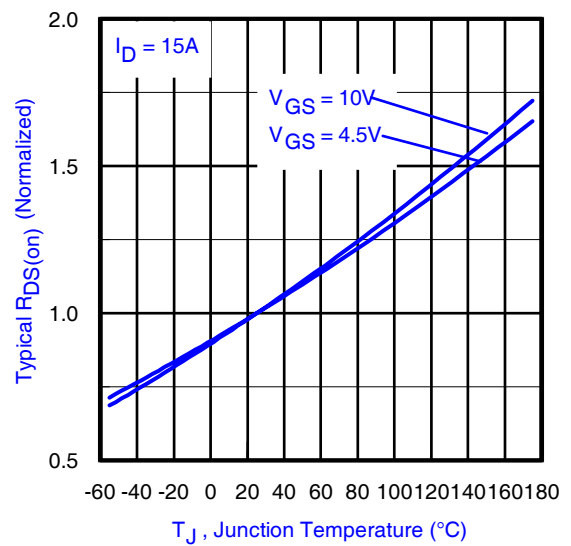
**Fig 4.** Typical Output Characteristics



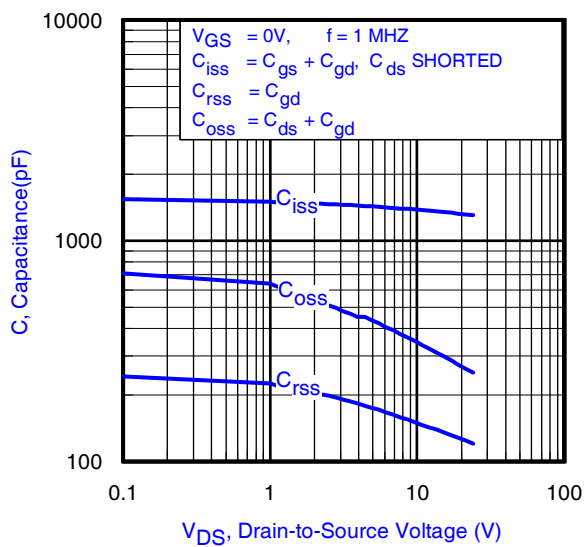
**Fig 5.** Typical Output Characteristics



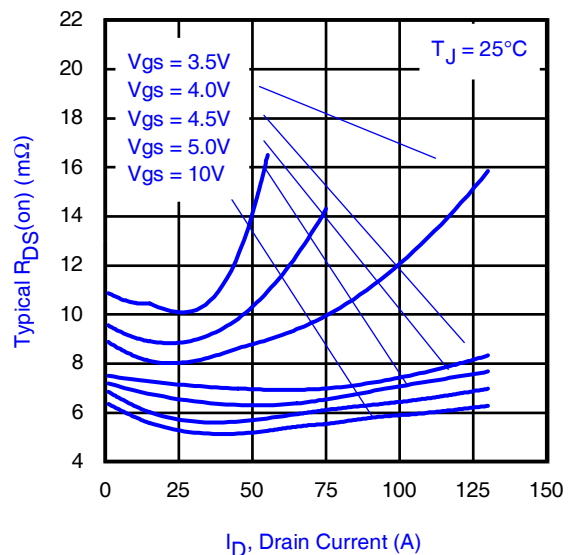
**Fig 6.** Typical Transfer Characteristics



**Fig 7.** Normalized On-Resistance vs. Temperature



**Fig 8.** Typical Capacitance vs. Drain-to-Source Voltage



**Fig 9.** Typical On-Resistance vs. Drain Current and Gate Voltage

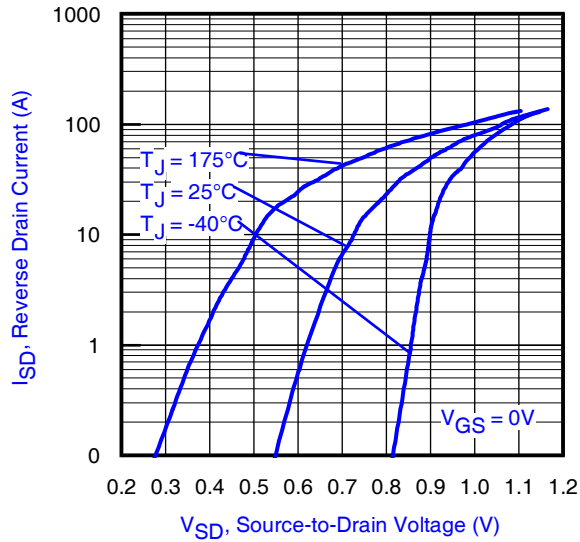


Fig 10. Typical Source-Drain Diode Forward Voltage

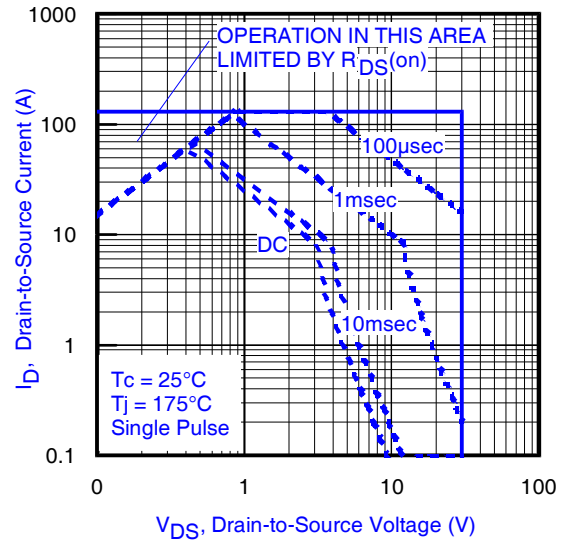


Fig 11. Maximum Safe Operating Area

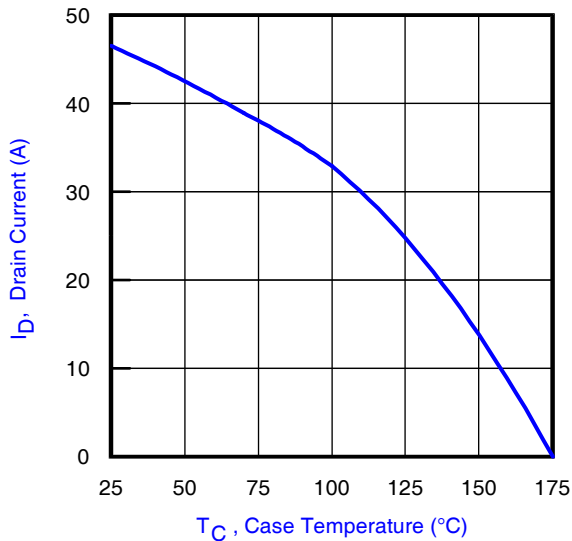


Fig 12. Maximum Drain Current vs. Case Temperature

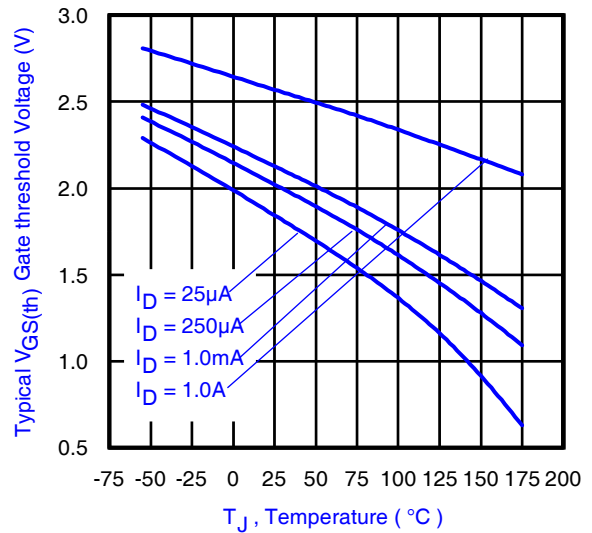


Fig 13. Typical Threshold Voltage vs. Junction Temperature

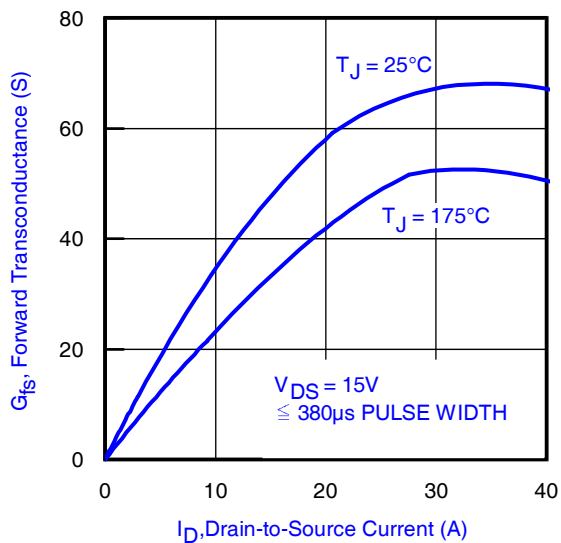


Fig 14. Typ. Forward Transconductance vs. Drain Current  
www.irf.com

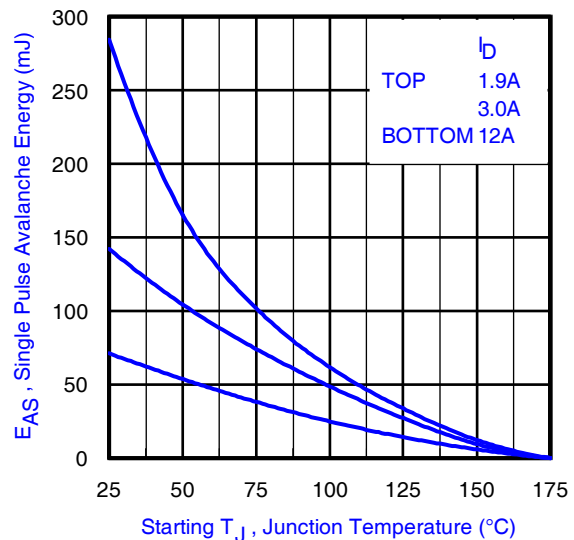
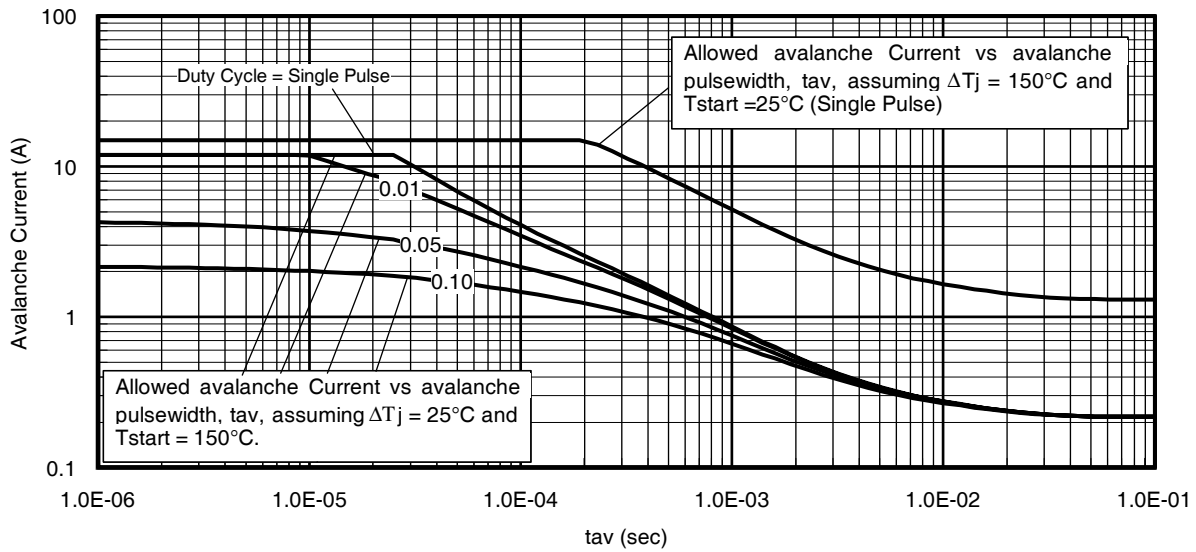
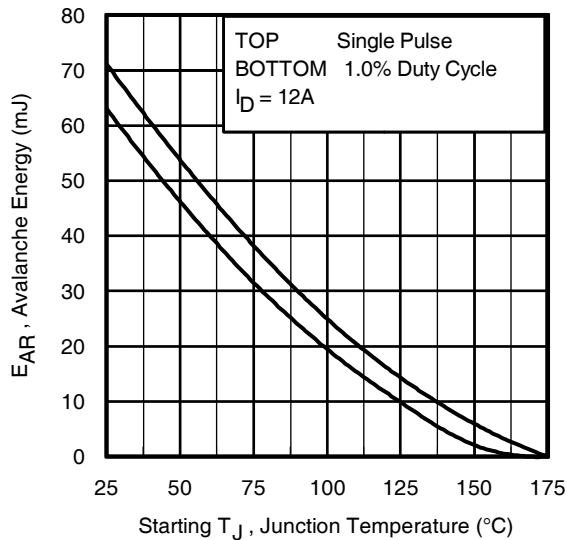


Fig 15. Maximum Avalanche Energy vs. Drain Current



**Fig 16.** Typical Avalanche Current vs.Pulsewidth



**Fig 17.** Maximum Avalanche Energy vs. Temperature

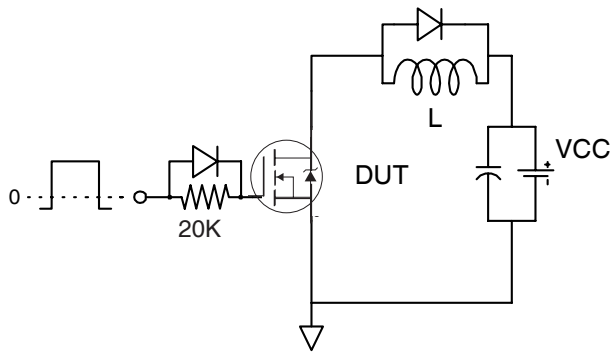
**Notes on Repetitive Avalanche Curves , Figures 16, 17:**  
**(For further info, see AN-1005 at www.irf.com)**

1. Avalanche failures assumption:  
Purely a thermal phenomenon and failure occurs at a temperature far in excess of  $T_{jmax}$ . This is validated for every part type.
2. Safe operation in Avalanche is allowed as long as  $T_{jmax}$  is not exceeded.
3. Equation below based on circuit and waveforms shown in Figures 19a, 19b.
4.  $P_{D(ave)}$  = Average power dissipation per single avalanche pulse.
5. BV = Rated breakdown voltage (1.3 factor accounts for voltage increase during avalanche).
6.  $I_{av}$  = Allowable avalanche current.
7.  $\Delta T$  = Allowable rise in junction temperature, not to exceed  $T_{jmax}$  (assumed as 25°C in Figure 16, 17).  
 $t_{av}$  = Average time in avalanche.  
 $D$  = Duty cycle in avalanche =  $t_{av} \cdot f$   
 $Z_{thJC}(D, t_{av})$  = Transient thermal resistance, see figure 11)

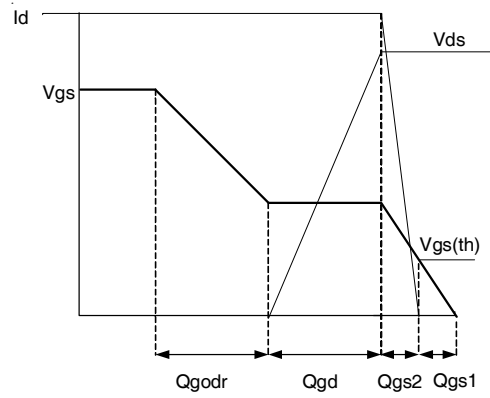
$$P_{D(ave)} = 1/2 ( 1.3 \cdot BV \cdot I_{av} ) = \Delta T / Z_{thJC}$$

$$I_{av} = 2\Delta T / [1.3 \cdot BV \cdot Z_{th}]$$

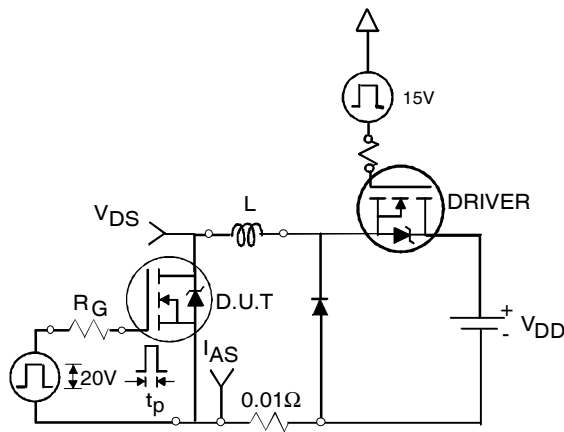
$$E_{AS(AR)} = P_{D(ave)} \cdot t_{av}$$



**Fig 18a.** Gate Charge Test Circuit



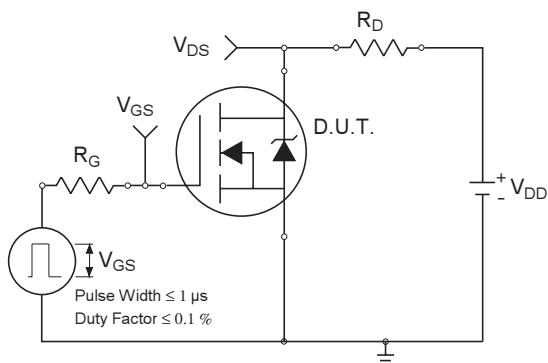
**Fig 18b.** Gate Charge Waveform



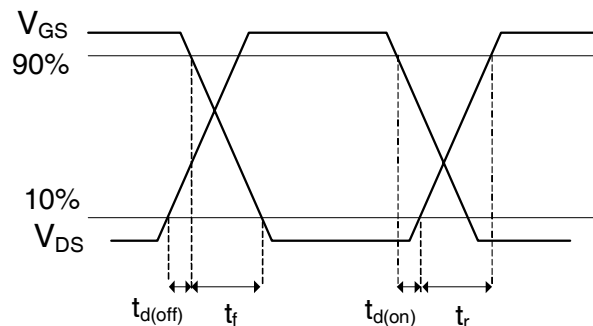
**Fig 19a.** Unclamped Inductive Test Circuit



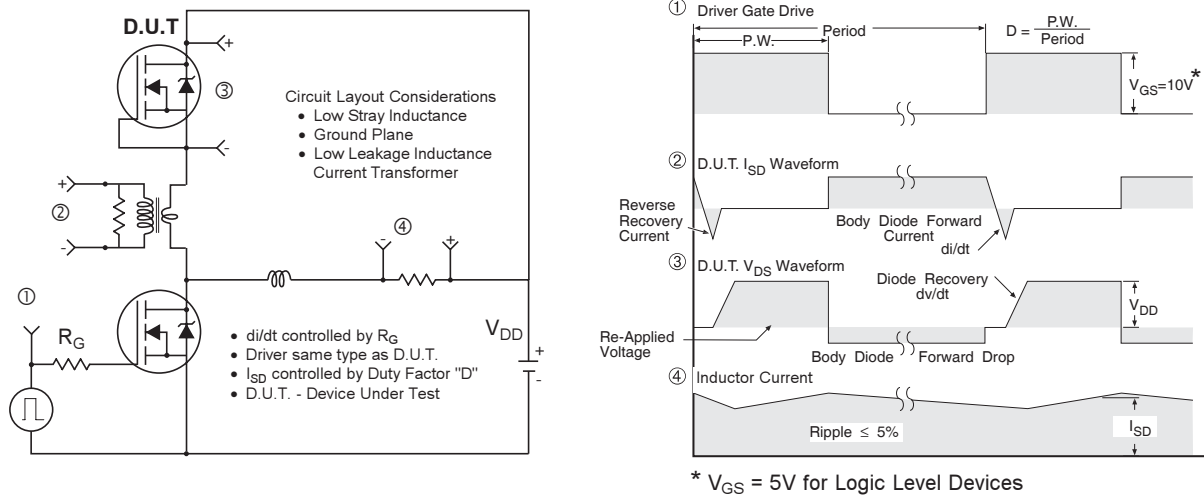
**Fig 19b.** Unclamped Inductive Waveforms



**Fig 20a.** Switching Time Test Circuit



**Fig 20b.** Switching Time Waveforms

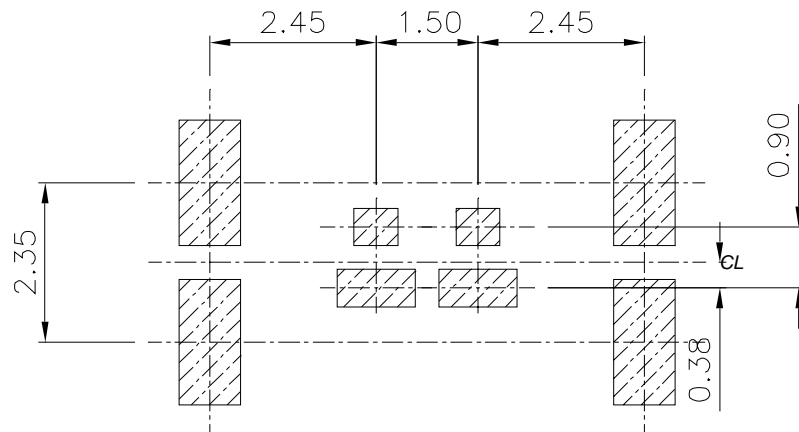


**Fig 19. Diode Reverse Recovery Test Circuit for N-Channel HEXFET® Power MOSFETs**

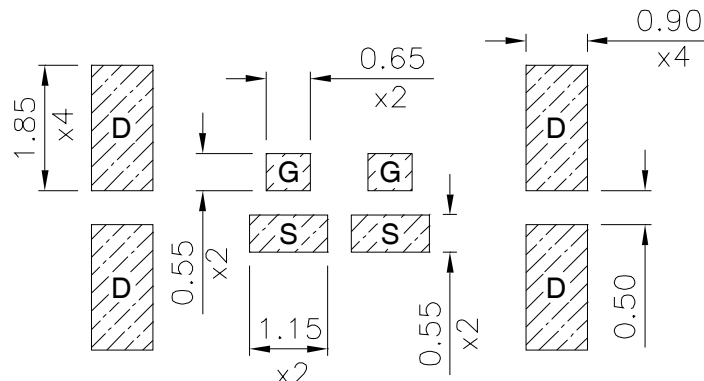
## DirectFET™ Board Footprint, MA Outline (Medium Size Can).

Please see DirectFET application note AN-1035 for all details regarding the assembly of DirectFET.

This includes all recommendations for stencil and substrate designs.



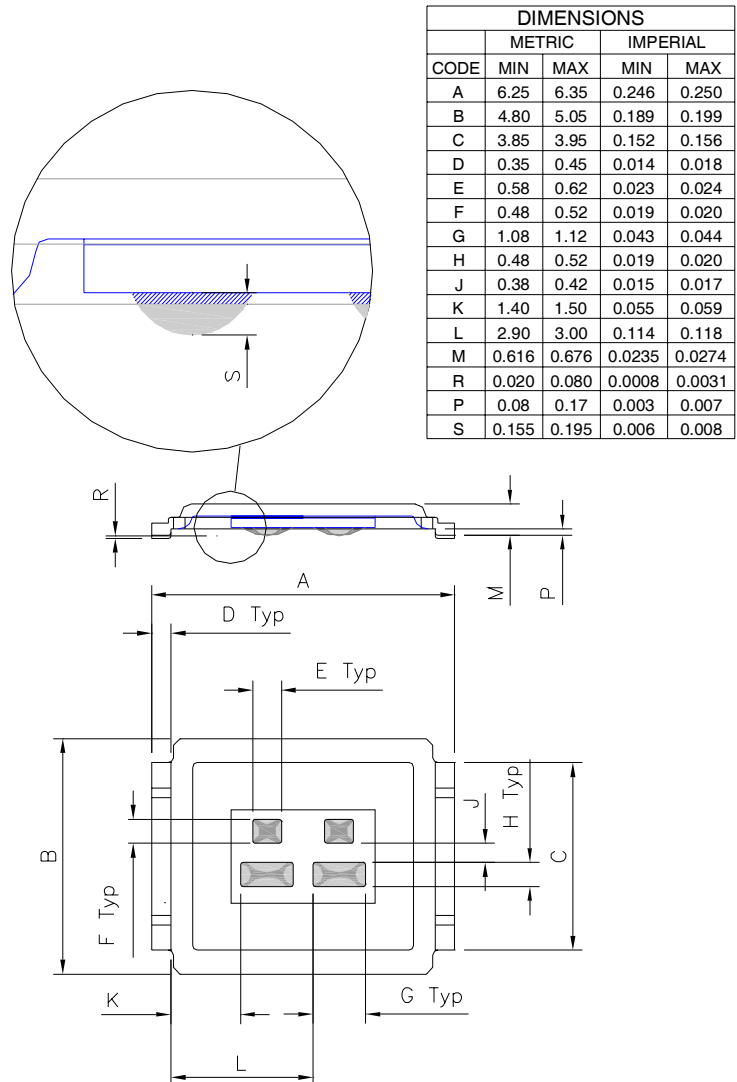
G = GATE  
D = DRAIN  
S = SOURCE



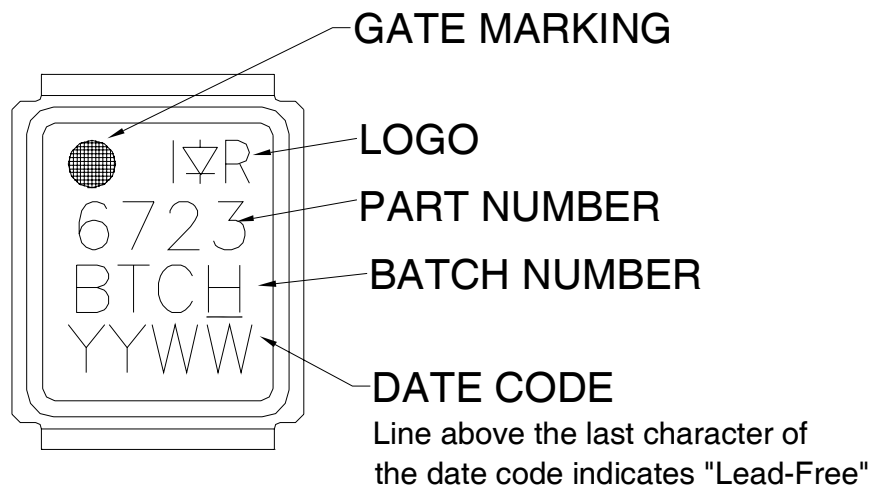


## DirectFET™ Outline Dimension, MA Outline (Medium Size Can).

Please see AN-1035 for DirectFET assembly details and stencil and substrate design recommendations

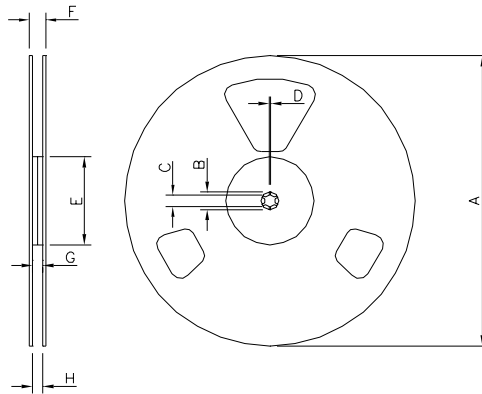


## DirectFET™ Part Marking



# IRF6723M2DTR/TR1PbF

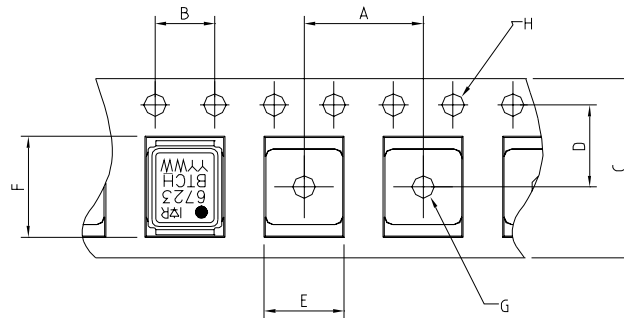
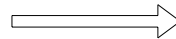
DirectFET™ Tape & Reel Dimension (Showing component orientation).



NOTE: Controlling dimensions in mm  
Std reel quantity is 4800 parts. IRF6723M2D

REEL DIMENSIONS				
STANDARD OPTION (QTY 4800)				
	METRIC		IMPERIAL	
CODE	MIN	MAX	MIN	MAX
A	330.0	N.C	12.992	N.C
B	20.2	N.C	0.795	N.C
C	12.8	13.2	0.504	0.520
D	1.5	N.C	0.059	N.C
E	100.0	N.C	3.937	N.C
F	N.C	18.4	N.C	0.724
G	12.4	14.4	0.488	0.567
H	11.9	15.4	0.469	0.606

LOADED TAPE FEED DIRECTION



NOTE: CONTROLLING DIMENSIONS IN MM

CODE	DIMENSIONS			
	METRIC		IMPERIAL	
	MIN	MAX	MIN	MAX
A	7.90	8.10	0.311	0.319
B	3.90	4.10	0.154	0.161
C	11.90	12.30	0.469	0.484
D	5.45	5.55	0.215	0.219
E	5.10	5.30	0.201	0.209
F	6.50	6.70	0.256	0.264
G	1.50	N.C	0.059	N.C
H	1.50	1.60	0.059	0.063

Data and specifications subject to change without notice.

This product has been designed and qualified to MSL1 rating for the Consumer market.

Additional storage requirement details for DirectFET products can be found in application note AN1035 on IR's Web site.

Qualification Standards can be found on IR's Web site.