

# IRLMS5703

HEXFET® Power MOSFET

- Generation V Technology
- Micro6 Package Style
- Ultra Low  $R_{DS(on)}$
- P-Channel MOSFET

## Description

Fifth Generation HEXFETs from International Rectifier utilize advanced processing techniques to achieve extremely low on-resistance per silicon area. This benefit, combined with the fast switching speed and ruggedized device design that HEXFET Power MOSFETs are well known for, provides the designer with an extremely efficient and reliable device for use in a wide variety of applications.

The Micro6 package with its customized leadframe produces a HEXFET power MOSFET with  $R_{DS(on)}$  60% less than a similar size SOT-23. This package is ideal for applications where printed circuit board space is at a premium. It's unique thermal design and  $R_{DS(on)}$  reduction enables a current-handling increase of nearly 300% compared to the SOT-23.

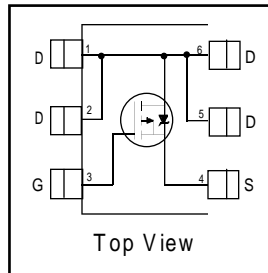

$V_{DSS} = -30V$

$R_{DS(on)} = 0.20\Omega$

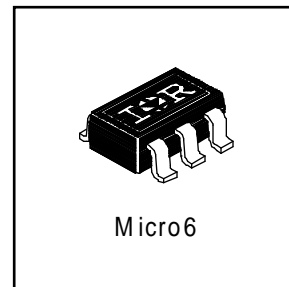

## Absolute Maximum Ratings

	Parameter	Max.	Units
$I_D @ T_A = 25^\circ C$	Continuous Drain Current, $V_{GS} @ -10V$	-2.3	A
$I_D @ T_A = 70^\circ C$	Continuous Drain Current, $V_{GS} @ -10V$	-1.9	
$I_{DM}$	Pulsed Drain Current ①	-13	
$P_D @ T_A = 25^\circ C$	Power Dissipation	1.7	W
	Linear Derating Factor	13	mW/°C
$V_{GS}$	Gate-to-Source Voltage	$\pm 20$	V
dv/dt	Peak Diode Recovery dv/dt ②	5.0	V/ns
$T_J, T_{STG}$	Junction and Storage Temperature Range	-55 to +150	°C

## Thermal Resistance Ratings

	Parameter	Min.	Typ.	Max	Units
$R_{\theta JA}$	Maximum Junction-to-Ambient ④	—	—	75	°C/W

## Electrical Characteristics @ $T_J = 25^\circ\text{C}$ (unless otherwise specified)

	Parameter	Min.	Typ.	Max.	Units	Conditions
$V_{(BR)DSS}$	Drain-to-Source Breakdown Voltage	-30	—	—	V	$V_{GS} = 0V, I_D = -250\mu A$
$\Delta V_{(BR)DSS}/\Delta T_J$	Breakdown Voltage Temp. Coefficient	—	0.01	—	V/ $^\circ\text{C}$	Reference to $25^\circ\text{C}$ , $I_D = -1mA$
$R_{DS(on)}$	Static Drain-to-Source On-Resistance	—	—	0.20	$\Omega$	$V_{GS} = -10V, I_D = -1.6A$ ④
		—	—	0.40		$V_{GS} = -4.5V, I_D = -0.80A$ ④
$V_{GS(th)}$	Gate Threshold Voltage	-1.0	—	—	V	$V_{DS} = V_{GS}, I_D = -250\mu A$
$g_{fs}$	Forward Transconductance	1.1	—	—	S	$V_{DS} = -10V, I_D = -0.80A$
$I_{DSS}$	Drain-to-Source Leakage Current	—	—	-1.0	$\mu A$	$V_{DS} = -24V, V_{GS} = 0V$
		—	—	-25		$V_{DS} = -24V, V_{GS} = 0V, T_J = 125^\circ\text{C}$
$I_{GSS}$	Gate-to-Source Forward Leakage	—	—	100	nA	$V_{GS} = -20V$
	Gate-to-Source Reverse Leakage	—	—	-100		$V_{GS} = 20V$
$Q_g$	Total Gate Charge	—	7.2	11	nC	$I_D = -1.6A$
$Q_{gs}$	Gate-to-Source Charge	—	1.4	2.1		$V_{DS} = -24V$
$Q_{gd}$	Gate-to-Drain ("Miller") Charge	—	2.3	3.4		$V_{GS} = -10V$ , See Fig. 6 and 9 ④
$t_{d(on)}$	Turn-On Delay Time	—	10	—		$V_{DD} = -15V$
$t_r$	Rise Time	—	12	—	ns	$I_D = -1.6A$
$t_{d(off)}$	Turn-Off Delay Time	—	20	—		$R_G = 6.2\Omega$
$t_f$	Fall Time	—	8.4	—		$R_D = 9.2\Omega$ , See Fig. 10 ④
$C_{iss}$	Input Capacitance	—	170	—		$V_{GS} = 0V$
$C_{oss}$	Output Capacitance	—	89	—	pF	$V_{DS} = -25V$
$C_{rss}$	Reverse Transfer Capacitance	—	44	—		$f = 1.0MHz$ , See Fig. 5

## Source-Drain Ratings and Characteristics

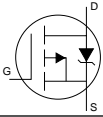
	Parameter	Min.	Typ.	Max.	Units	Conditions
$I_S$	Continuous Source Current (Body Diode)	—	—	-1.7	A	MOSFET symbol showing the integral reverse p-n junction diode. 
$I_{SM}$	Pulsed Source Current (Body Diode) ①	—	—	-13		
$V_{SD}$	Diode Forward Voltage	—	—	-1.2	V	$T_J = 25^\circ\text{C}, I_S = -1.6A, V_{GS} = 0V$ ③
$t_{rr}$	Reverse Recovery Time	—	29	44	ns	$T_J = 25^\circ\text{C}, I_F = -1.6A$
$Q_{rr}$	Reverse Recovery Charge	—	27	41	nC	$di/dt = -100A/\mu s$ ③

### Notes:

- ① Repetitive rating; pulse width limited by max. junction temperature. ( See fig. 11 )
- ②  $I_{SD} \leq -1.6A, di/dt \leq -140A/\mu s, V_{DD} \leq V_{(BR)DSS}, T_J \leq 150^\circ\text{C}$
- ③ Pulse width  $\leq 300\mu s$ ; duty cycle  $\leq 2\%$ .
- ④ Surface mounted on FR-4 board,  $t \leq 5sec$ .

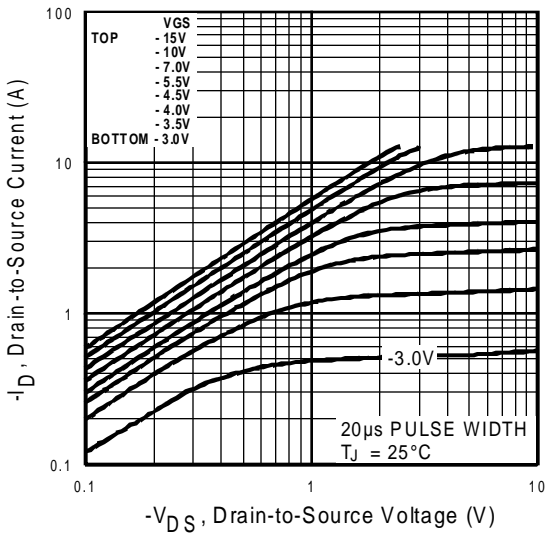

**Fig 1.** Typical Output Characteristics

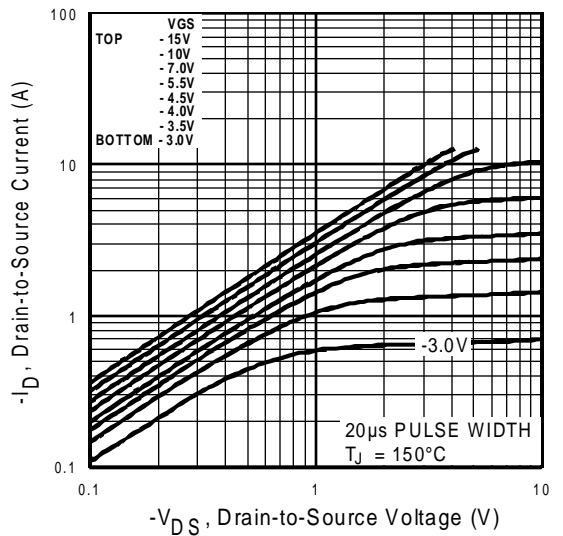

**Fig 2.** Typical Output Characteristics

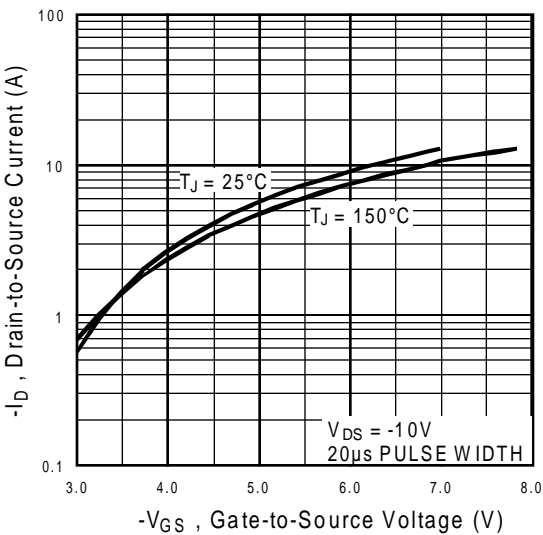

**Fig 3.** Typical Transfer Characteristics

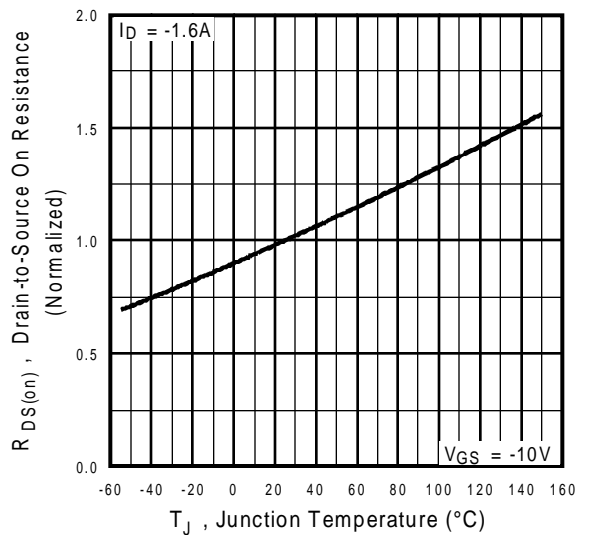

**Fig 4.** Normalized On-Resistance Vs. Temperature

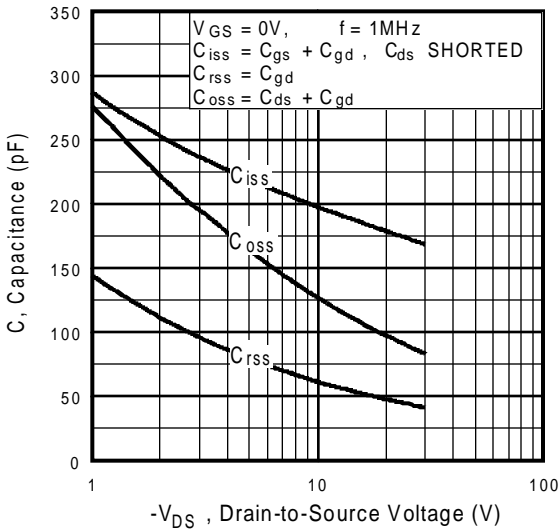

**Fig 5.** Typical Capacitance Vs. Drain-to-Source Voltage

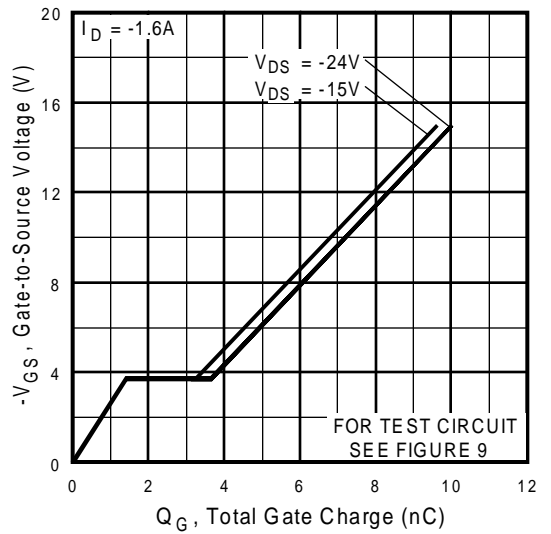

**Fig 6.** Typical Gate Charge Vs. Gate-to-Source Voltage

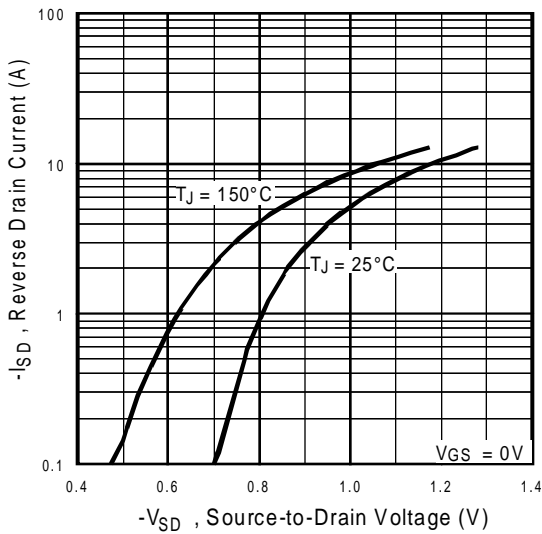

**Fig 7.** Typical Source-Drain Diode Forward Voltage

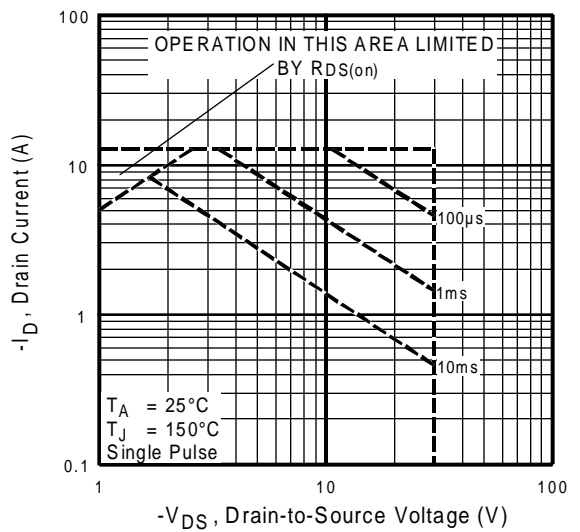

**Fig 8.** Maximum Safe Operating Area

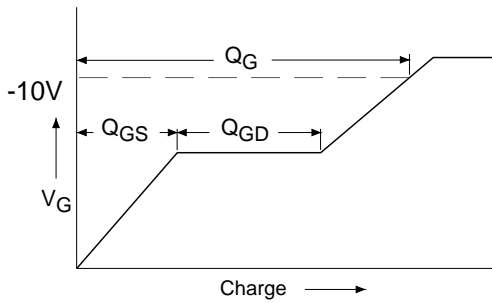

Fig 9a. Basic Gate Charge Waveform

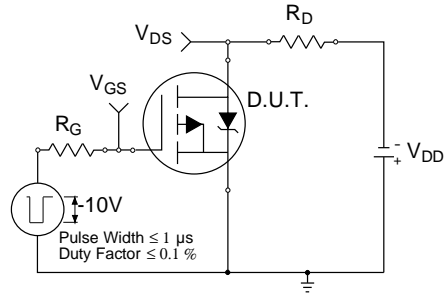

Fig 10a. Switching Time Test Circuit

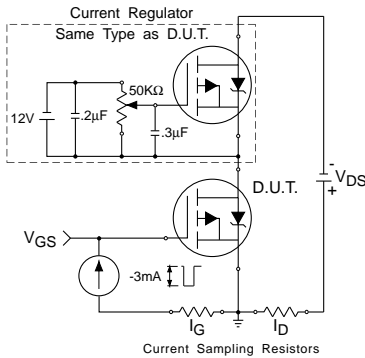

Fig 9b. Gate Charge Test Circuit

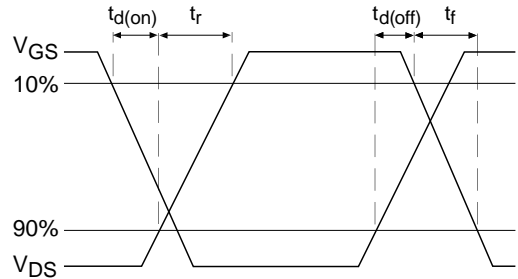

Fig 10b. Switching Time Waveforms

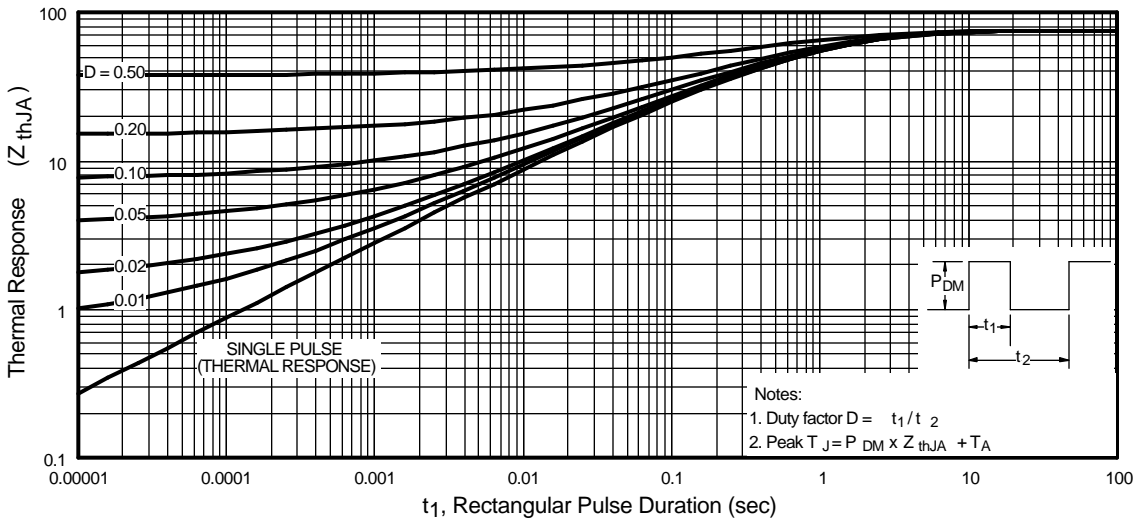
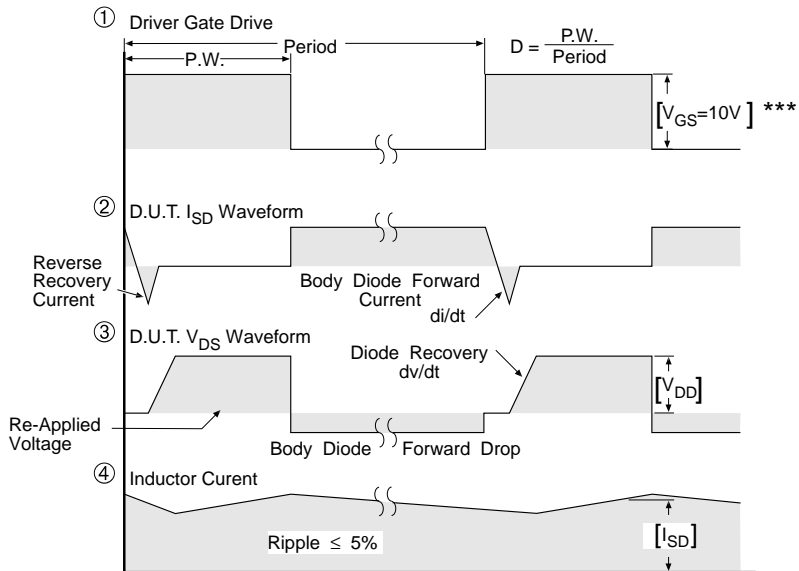
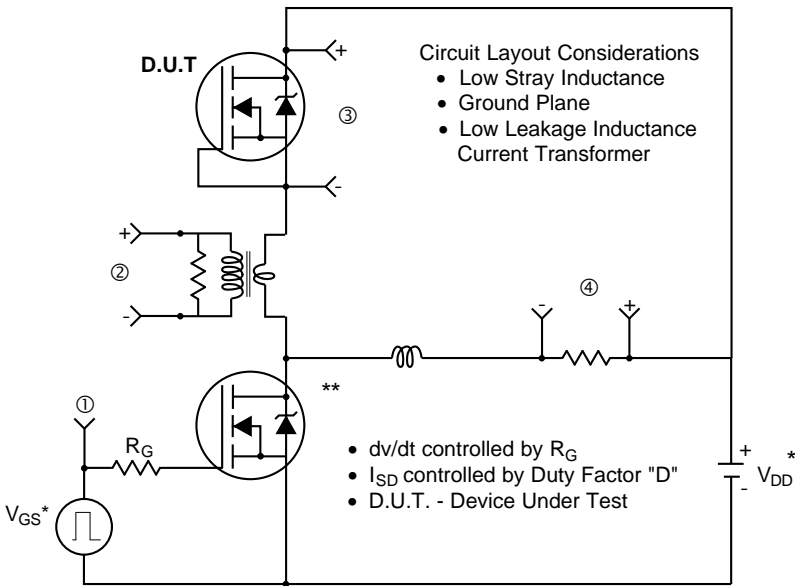

Fig 11. Maximum Effective Transient Thermal Impedance, Junction-to-Ambient

## Peak Diode Recovery dv/dt Test Circuit



\*\*\*  $V_{GS} = 5.0V$  for Logic Level and 3V Drive Devices

**Fig 13.** For P-Channel HEXFETS

## Micro6™ Package Outline

Dimensions are shown in millimeters (inches)

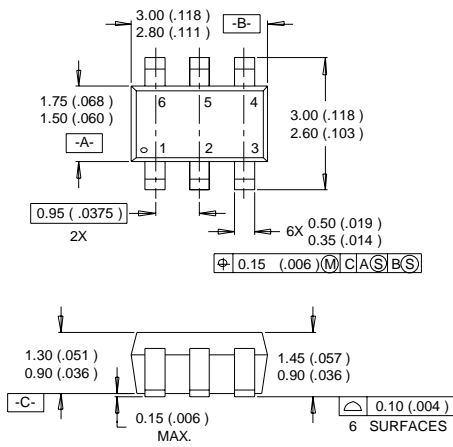

### LEAD ASSIGNMENTS

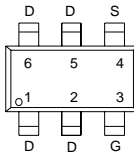

### RECOMMENDED FOOTPRINT

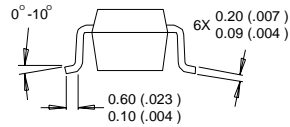
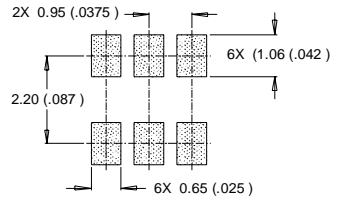

### NOTES :

1. DIMENSIONING & TOLERANCING PER ANSI Y14.5M-1982.
2. CONTROLLING DIMENSION : MILLIMETER.
3. DIMENSIONS ARE SHOWN IN MILLIMETERS (INCHES).

# IRLMS5703



## Micro6™ Part Marking Information

Notes: This part marking information applies to devices produced before 02/26/2001

EXAMPLE: THIS IS AN IRLMS6702

WW = (1-26) IF PRECEDED BY LAST DIGIT OF CALENDAR YEAR

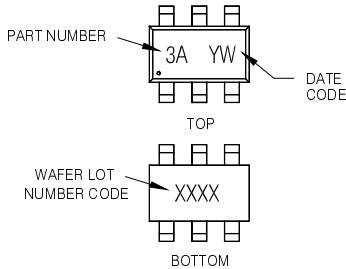

YEAR	Y	WORK WEEK	W
2001	1	01	A
2002	2	02	B
2003	3	03	C
2004	4	04	D
2005	5		
1996	6		
1997	7		
1998	8		
1999	9		
2000	0	24	X
		25	Y
		26	Z

PART NUMBER CODE REFERENCE:

- 2A = IRLMS1902
- 2B = IRLMS1503
- 2C = IRLMS6702
- 2D = IRLMS5703
- 2E = IRLMS6802
- 2F = IRLMS4502
- 2G = IRLMS2002
- 2H = IRLMS6803

DATE CODE EXAMPLES:

- YWW = 9603 = 6C
- YWW = 9632 = FF

WW = (27-52) IF PRECEDED BY A LETTER

YEAR	Y	WORK WEEK	W
2001	A	27	A
2002	B	28	B
2003	C	29	C
2004	D	30	D
2005	E		
1996	F		
1997	G		
1998	H		
1999	J		
2000	K	50	X
		51	Y
		52	Z

Notes: This part marking information applies to devices produced after 02/26/2001

W = (1-26) IF PRECEDED BY LAST DIGIT OF CALENDAR YEAR

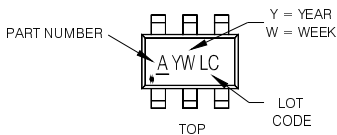

YEAR	Y	WORK WEEK	W
2001	1	01	A
2002	2	02	B
2003	3	03	C
2004	4	04	D
2005	5		
1996	6		
1997	7		
1998	8		
1999	9		
2000	0	24	X
		25	Y
		26	Z

PART NUMBER CODE REFERENCE:

- A = IRLMS1902
- B = IRLMS1503
- C = IRLMS6702
- D = IRLMS5703
- E = IRLMS6802
- F = IRLMS4502
- G = IRLMS2002
- H = IRLMS6803

W = (27-52) IF PRECEDED BY A LETTER

YEAR	Y	WORK WEEK	W
2001	A	27	A
2002	B	28	B
2003	C	29	C
2004	D	30	D
2005	E		
1996	F		
1997	G		
1998	H		
1999	J		
2000	K	50	X
		51	Y
		52	Z



## Micro6™ Tape & Reel Information

Dimensions are shown in millimeters (inches)

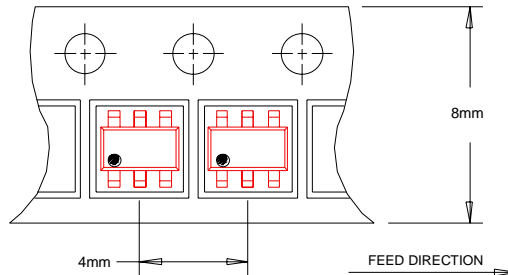

- NOTES :
1. OUTLINE CONFORMS TO EIA-481 & EIA-541.

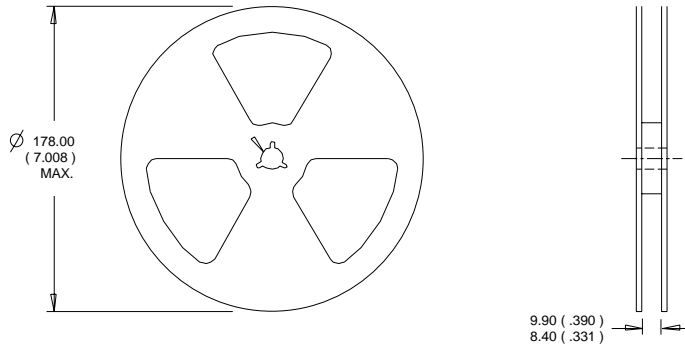

- NOTES:
1. CONTROLLING DIMENSION : MILLIMETER.
  2. OUTLINE CONFORMS TO EIA-481 & EIA-541.

Data and specifications subject to change without notice.

International  
**IOR** Rectifier

IR WORLD HEADQUARTERS: 233 Kansas St., El Segundo, California 90245, USA Tel: (310) 252-7105  
TAC Fax: (310) 252-7903

Visit us at [www.irf.com](http://www.irf.com) for sales contact information. 04/04