

MOLEX P/N	CIRCUIT SIZE	HOUSING MATERIAL	HOUSING COLOR	TERMINAL MATERIAL	CONTACT PLATING	SOLDERTAIL PLATING	DIM "B"
87715-9920	200	NYLON46	BLACK	PHOSPHOR BRONZE	GOLD 30 MICROINCH	100 MICROINCH TIN OVER NICKEL OVERALL	2.54
87715-9921							3.00

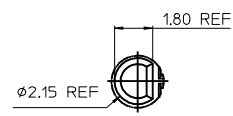

DETAIL A

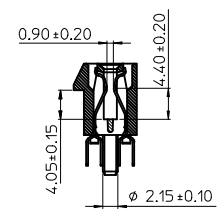
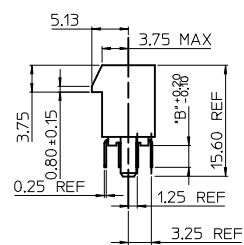

SECTION A-A

△ NOTES:

- MATERIALS:
 - HOUSING:SEE TABLE, GLASS FIBER FILLED, UL94V-0, COLOR:SEE TABLE
 - CONTACT:SEE TABLE
- PLATING:
 - CONTACT AREA:SEE TABLE
 - SOLDER TAIL:SEE TABLE
 - UNDER PLATING:SEE TABLE
- DATE CODE:TO BE PRINTED
- PRODUCT SPECIFICATION REFER TO PS-87715-200
- PACKAGING SPECIFICATION REFER TO PK-87715-212
- TEST SUMMARY:REFER TO TS-87715-212
- LEAD-FREE AND ROHS COMPLIANT PRODUCT

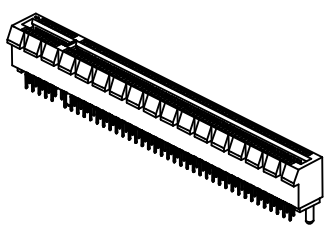

DRAWING ERROR EC NO: SH2007-0602 DRWN:ALL IN 2007/02/14 CHKD: 2007/02/14 APPR:WMSCHANG 2007/02/14	QUALITY SYMBOLS ▽=0 ▽=0	GENERAL TOLERANCES (UNLESS SPECIFIED)		DIMENSION STYLE MM ONLY		SCALE	DESIGN UNITS METRIC	THIRD ANGLE PROJECTION		
			mm	INCH	DRAWN BY	DATE	TITLE △ 1.00 PITCH EDGE CARD 200 PIN VERT DIP CONN			
		4 PLACES	± ---	± ---	TOM	2005/03/13				
		3 PLACES	± ---	± ---	CHECKED BY	DATE	MOLEX INCORPORATED DOCUMENT NO. SD-87715-212 SHEET NO. 1 OF 2			
2 PLACES	± 0.25	± ---	ALLEN LIN	2005/03/13						
1 PLACE	± 0.25	± ---	APPROVED BY	DATE	THIS DRAWING CONTAINS INFORMATION THAT IS PROPRIETARY TO MOLEX INCORPORATED AND SHOULD NOT BE USED WITHOUT WRITTEN PERMISSION					
ANGULAR ± 3 °		DRAFT WHERE APPLICABLE MUST REMAIN WITHIN DIMENSIONS		WILSON CHANG					2005/03/13	
REV	DESCRIPTION			MATERIAL NO.						

7 6 5 4 3 2 1

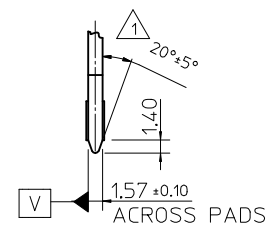
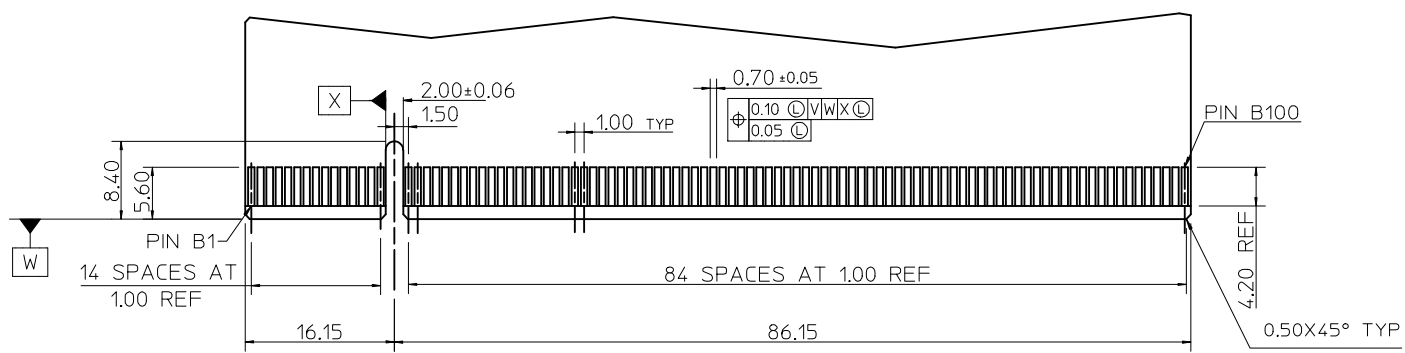

← I/O PANEL DIRECTION
 △ PRIMARY (COMPONENT) SIDE

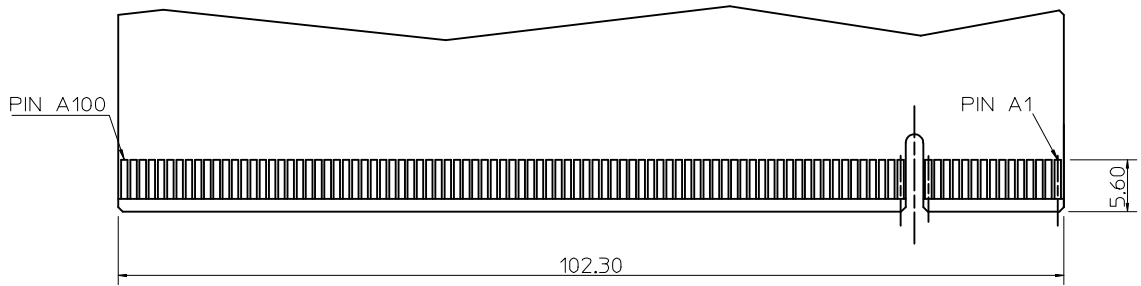

I/O PANEL → DIRECTION
 SECONDARY (SOLDER) SIDE

NOTES :
 △ CHAMFER EDGES MUST BE FREE OF CUTTING BURRS.

SEE SHEET 1 EC NO: SH2007-0602 2007/02/14 DRWN: ALL IN 2007/02/14 CHKD: 2007/02/14 APPR: WMSCHANG 2007/02/14	DESCRIPTION REV	QUALITY SYMBOLS	GENERAL TOLERANCES (UNLESS SPECIFIED)		DIMENSION STYLE MM ONLY		SCALE 1:1	DESIGN UNITS METRIC	THIRD ANGLE PROJECTION		
		▽=0	mm	INCH	DRAWN BY	DATE	TITLE △ 1.00 PITCH EDGE CARD 200 PIN VERT DIP CONN				
		∇=0	4 PLACES ± ---	± ---	TOM	2005/03/13					
			3 PLACES ± ---	± ---	CHECKED BY	DATE	MOLEX MOLEX INCORPORATED				
			2 PLACES ± 0.25	± ---	ALLEN LIN	2005/03/13					
	1 PLACE ± 0.25	± ---	APPROVED BY	DATE	MATERIAL NO.		DOCUMENT NO.	SHEET NO.			
DRAFT WHERE APPLICABLE MUST REMAIN WITHIN DIMENSIONS			ANGULAR ± 3 °		SEE TABLE		SD-87715-212		2 OF 2		
					SIZE A 4		THIS DRAWING CONTAINS INFORMATION THAT IS PROPRIETARY TO MOLEX INCORPORATED AND SHOULD NOT BE USED WITHOUT WRITTEN PERMISSION				

6 5 4 3 2 1