

LC QUAD ADAPTER P/N	LC QUAD ADAPTER COLOR	SPLIT SLEEVE MATERIAL
106123-0200	BLUE	ZR
106123-0205*		
106123-1200	BEIGE	PHOSPHOR BRONZE
106123-1205*		
106123-2200	GREEN	ZR
106123-3200	AQUA	PHOSPHOR BRONZE
106123-3205*		

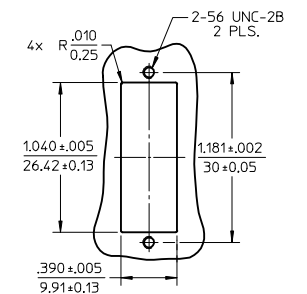

**RECOMMENDED
MOUNTING PATTERN**
SCALE 1.5:1

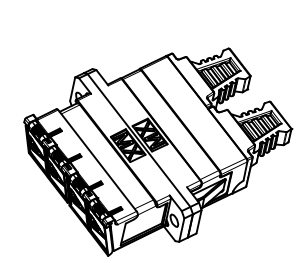
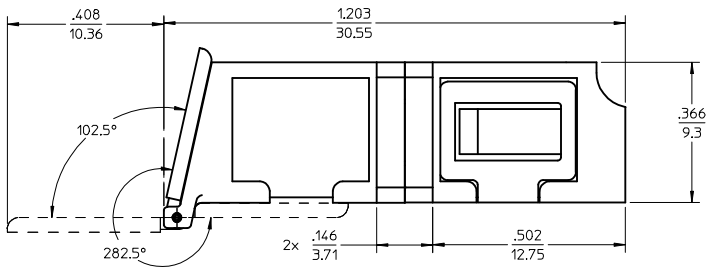
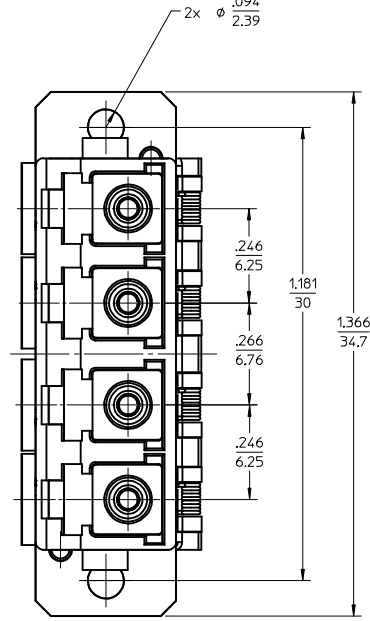
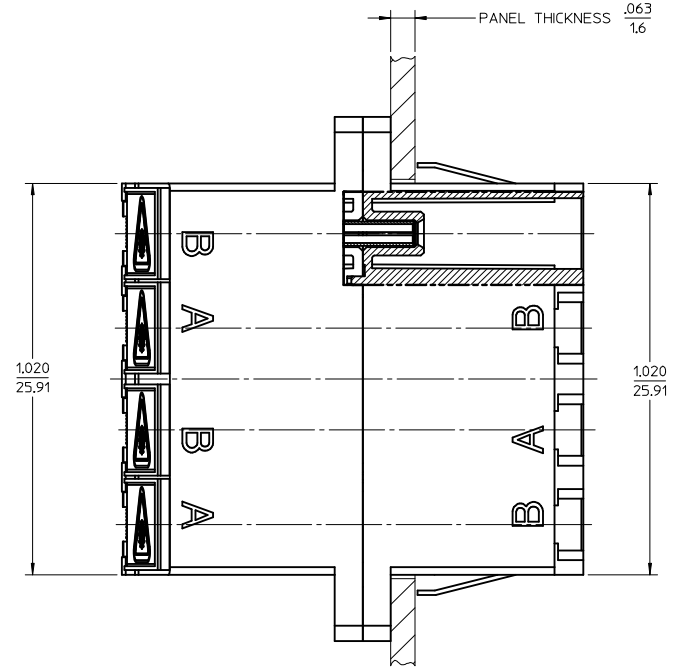
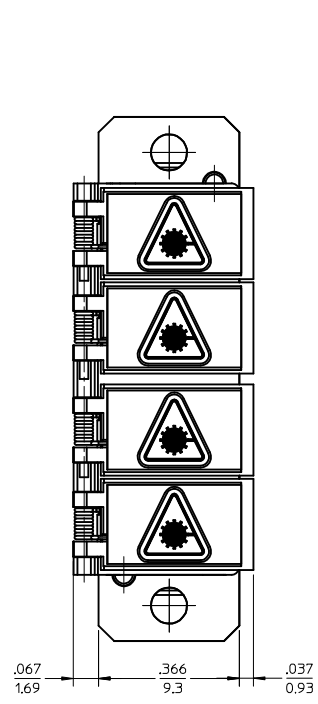

ISO VIEW 2
SCALE 1.5:1

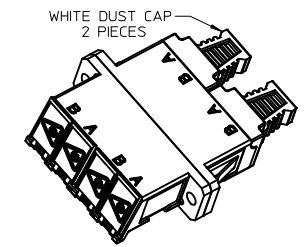

ISO VIEW 1
SCALE 1.5:1

- NOTES:
- ALL DIMENSIONS ARE FOR REFERENCE.
 - DUST CAPS NOT SHOWN ON FRONT, BOTTOM AND RIGHT VIEW.
 - LC QUAD ADAPTER HAS SC DUPLEX ADAPTER FOOTPRINT.
 - *4. P/Ns MARKED WITH(*) ARE BULK PACKED IN QUANTITIES OF 100 pcs.

ENTER DESCRIPTION IEC NO: MF-2013-0549 DRW:KPEVZNER 2013/03/04 CHKD: APPR:IGUMIN 2013/03/07 REV:	QUALITY SYMBOLS ▽=0 ▽=0	GENERAL TOLERANCES (UNLESS SPECIFIED) <table border="1"> <tr> <th></th> <th>mm</th> <th>INCH</th> </tr> <tr> <td>4 PLACES</td> <td>±---</td> <td>±---</td> </tr> <tr> <td>3 PLACES</td> <td>±---</td> <td>±---</td> </tr> <tr> <td>2 PLACES</td> <td>±---</td> <td>±---</td> </tr> <tr> <td>1 PLACE</td> <td>±---</td> <td>±---</td> </tr> <tr> <td colspan="3">ANGULAR ±---°</td> </tr> </table>		mm	INCH	4 PLACES	±---	±---	3 PLACES	±---	±---	2 PLACES	±---	±---	1 PLACE	±---	±---	ANGULAR ±---°			DIMENSION STYLE IN/MM	SCALE 4:1	DESIGN UNITS INCH	THIRD ANGLE PROJECTION
		mm	INCH																					
	4 PLACES	±---	±---																					
	3 PLACES	±---	±---																					
2 PLACES	±---	±---																						
1 PLACE	±---	±---																						
ANGULAR ±---°																								
DRAFT WHERE APPLICABLE MUST REMAIN WITHIN DIMENSIONS		DRAWN BY PGIBL IN	DATE 2005/11/21	LC QUAD ADAPTER WITH SHUTTERS (SCREW AND SNAP MOUNT)																				
MATERIAL NO. SEE TABLE		CHECKED BY	DATE	MOLEX INCORPORATED																				
SIZE C		APPROVED BY		DATE	DOCUMENT NO. SD-106123-X200	SHEET NO. 1 OF 1																		