

SECTION A-A

NOTES:

1. MATERIAL:
  - HOUSING: THERMAL PLASTIC, G.F., UL94V-0, COLOR: BLACK
  - COVER: THERMAL PLASTIC, COLOR: BLACK
  - TERMINAL: COPPER ALLOY
  - METAL LATCH: STAINLESS STEEL
2. TERMINAL PLATING:
  - CONTACT AREA: GOLD PLATED
  - IDT TAIL: PLATE TIN, 1.9 MICRONS MINIMUM
  - UNDER PLATE: PLATE NICKEL 1.25 MICRONS MINIMUM
3. PACKAGING: TRAY
4. PRODUCT SPECIFICATION REFER TO PS-67490-001
5. ASSEMBLE WITH COVER 679260040/0041 AFTER WIRE TERMINATION
6. MATING PART 87679
7. RECOMMENDED TERMINATING WIRE SIZE: SEE TABLE
8. PRODUCT COMPLIANT TO RoHS DIRECTIVE 2002/95/EC AND ELV DIRECTIVE 2000/53/EC

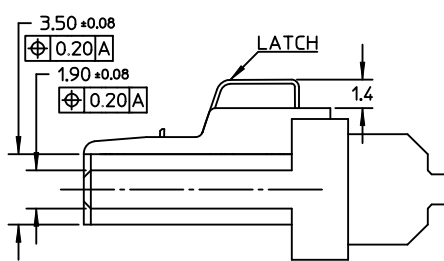
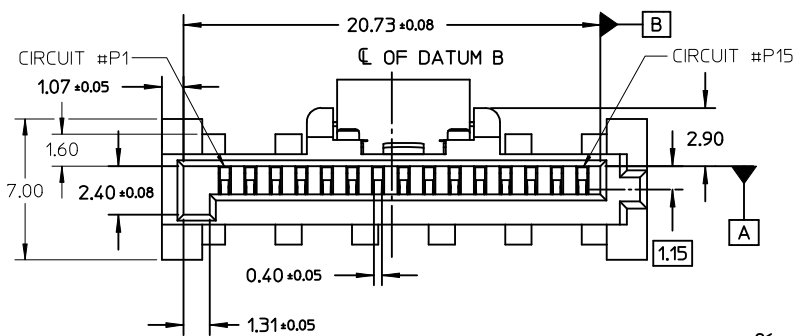
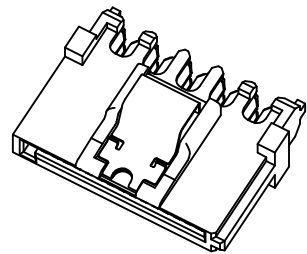

WITH LATCH TYPE

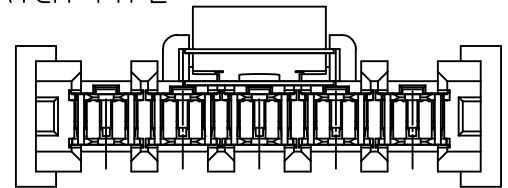

REMOVE PART NUMBER EC NO: SH2012-0062 DRWN: XQZHANG 2012/01/18 CHKD: XQZHANG 2012/01/30 APPR: ATIN 2012/02/02	DESCRIPTION QUALITY SYMBOLS $\nabla_A = 0$ $\nabla_C = 0$ $\nabla_P = 0$	GENERAL TOLERANCES (UNLESS SPECIFIED)		DIMENSION STYLE MM ONLY		SCALE 4:1	DESIGN UNITS METRIC	THIRD ANGLE PROJECTION		
				mm	INCH	DRAWN BY GRATE MA	DATE 2004/01/17	TITLE SERIAL ATA POWER CONNECTOR IDT TYPE		
				4 PLACES ± ---	± ---	CHECKED BY YA JUN	DATE 2004/01/17			
				ANGULAR ± 1 °		APPROVED BY SAM	DATE 2004/01/17	MOLEX INCORPORATED		
		DRAFT WHERE APPLICABLE MUST REMAIN WITHIN DIMENSIONS		MATERIAL NO. SEE SHEET 3		DOCUMENT NO. SD-67926-001	SHEET NO. 1 OF 3			
				SIZE A3		THIS DRAWING CONTAINS INFORMATION THAT IS PROPRIETARY TO MOLEX INCORPORATED AND SHOULD NOT BE USED WITHOUT WRITTEN PERMISSION				

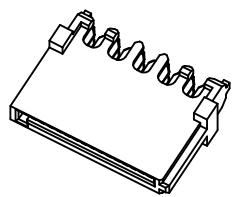
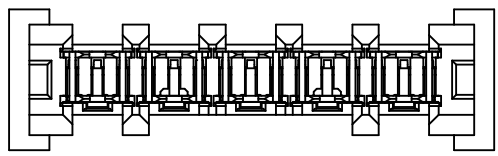

WITHOUT LATCH TYPE

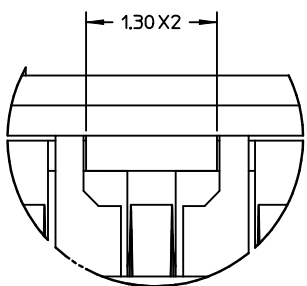
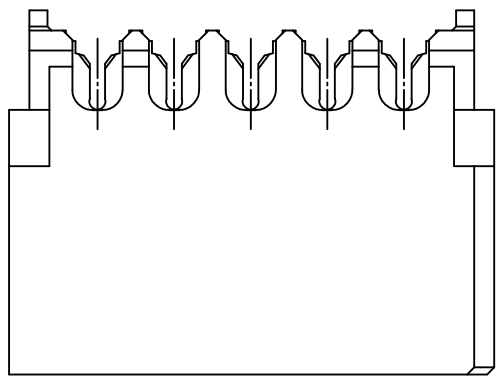

Detail2

SCALE 20:1

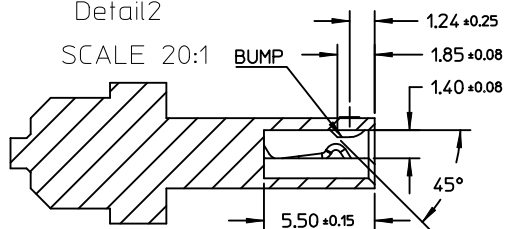

SECTION B-B

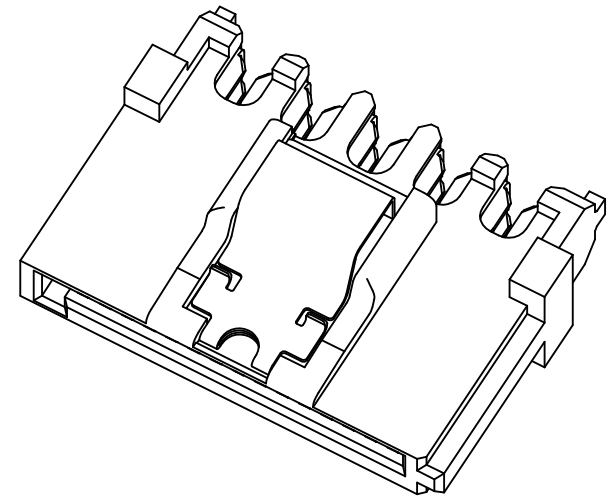
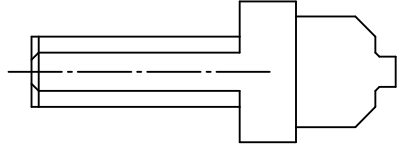

See Detail2

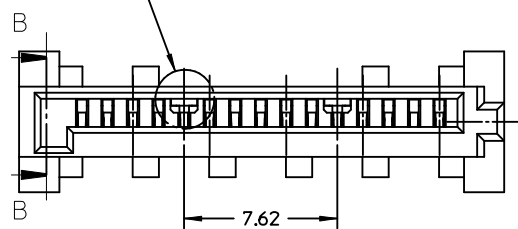

NOTES:  
OTHER INFORMATION REFER TO SHEET 1

SEE SHEET 1 EC NO: SH2012-0062 DRWN: XZZHANG CHKD: XZZHANG APPR: AYIN	2012/01/18 2012/01/30 2012/02/02	QUALITY SYMBOLS ▽=0 ▽=0 ▽=0	GENERAL TOLERANCES (UNLESS SPECIFIED)		DIMENSION STYLE	SCALE	DESIGN UNITS	THIRD ANGLE PROJECTION		
					MM ONLY	4:1	METRIC			
			mm	INCH	DRAWN BY DATE		TITLE			
			4 PLACES ± ---	± ---	GRATE MA	2004/01/17				
3 PLACES ± ---	± ---	CHECKED BY DATE		SERIAL ATA POWER CONNECTOR IDT TYPE						
2 PLACES ± 0.25	± ---	YAJUN	2004/01/17							
1 PLACE ± 0.30	± ---	APPROVED BY DATE		MOLEX INCORPORATED						
ANGULAR ± 1°		SAM	2004/01/17							
DRAFT WHERE APPLICABLE MUST REMAIN WITHIN DIMENSIONS		MATERIAL NO.		DOCUMENT NO.		SHEET NO.				
		SEE SHEET 3		SD-67926-001		2 OF 3				
		THIS DRAWING CONTAINS INFORMATION THAT IS PROPRIETARY TO MOLEX INCORPORATED AND SHOULD NOT BE USED WITHOUT WRITTEN PERMISSION								

P/N	RECOMMENDED WIRE SIZE	PLATE TYPE	REMARK
67926-0001	18AWG	GOLD FLASH	WITH LATCH, WITHOUT BUMP
67926-0401	22AWG		
67926-0002	18AWG	0.76 MICRON GOLD PLATED	
67926-0302	20AWG		
67926-0402	22AWG		
67926-0005	18AWG	0.38 MICRON GOLD PLATED	
67926-0305	20AWG		
67926-0405	22AWG		
67926-0021	18AWG	GOLD FLASH	WITH LATCH, WITH BUMP
67926-0321	20AWG		
67926-0421	22AWG		
67926-0022	18AWG	0.76 MICRON GOLD PLATED	
67926-0322	20AWG		
67926-0422	22AWG		
67926-0025	18AWG	0.38 MICRON GOLD PLATED	
67926-0425	22AWG		
67926-0011	18AWG		GOLD FLASH
67926-0311	20AWG		
67926-0411	22AWG		
67926-0012	18AWG	0.76 MICRON GOLD PLATED	
67926-0412	22AWG		
67926-0015	18AWG		0.38 MICRON GOLD PLATED
67926-0315	20AWG		
67926-0415	22AWG		

SEE SHEET 1 EC NO: SH2012-0062 DRWN: XQZHANG CHKD: XQZHANG APPR: AYIN	2012/01/18 2012/01/30 2012/02/02	DESCRIPTION REV	QUALITY SYMBOLS	GENERAL TOLERANCES (UNLESS SPECIFIED)	DIMENSION STYLE	SCALE	DESIGN UNITS	THIRD ANGLE PROJECTION			
			$F_A=0$ $F_G=0$ $F_P=0$	mm      INCH 4 PLACES ± --- ± --- 3 PLACES ± --- ± --- 2 PLACES ± 0.25 ± --- 1 PLACE ± 0.30 ± --- ANGULAR ± 1°	MM ONLY	4:1	METRIC	DRAWN BY: GRATE MA      DATE: 2004/01/17 CHECKED BY: YA JUN      DATE: 2004/01/17 APPROVED BY: SAM      DATE: 2004/01/17	SERIAL ATA POWER CONNECTOR IDT TYPE		
			DRAFT WHERE APPLICABLE MUST REMAIN WITHIN DIMENSIONS		SEE TABLE	MOLEX INCORPORATED DOCUMENT NO. SD-67926-001		SHEET NO. 3 OF 3			
			SIZE A3		THIS DRAWING CONTAINS INFORMATION THAT IS PROPRIETARY TO MOLEX INCORPORATED AND SHOULD NOT BE USED WITHOUT WRITTEN PERMISSION						