

7 6 5 4 3 2 1

E

E

D

D

C

C

B

B

A

A

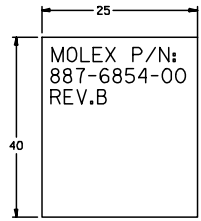
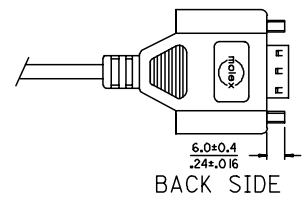
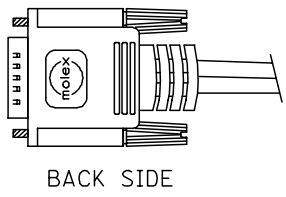
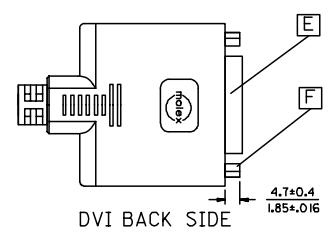
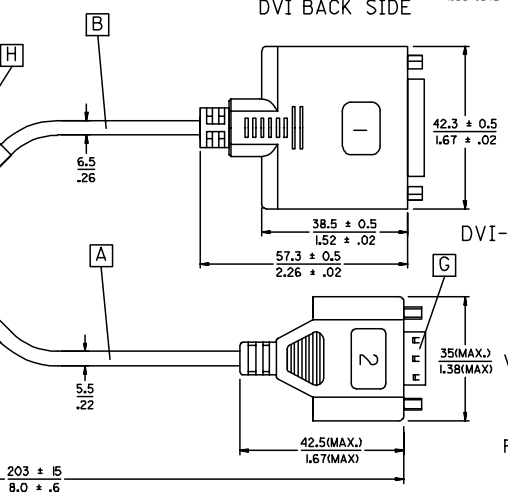
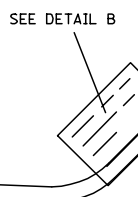
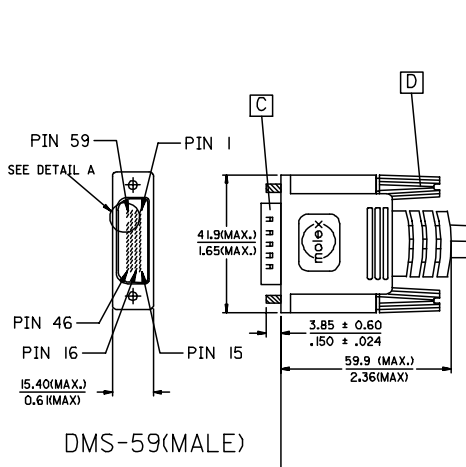
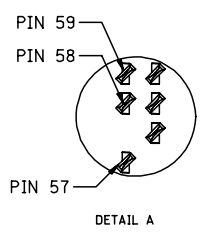

ENTER DESCRIPTION EC NO: DG2006-0186 DRWN:PDAI 2006/03/09 CHKD: 2006/03/09 APPR:TKAN 2006/03/10 DESCRIPTION REV	QUALITY SYMBOLS	GENERAL TOLERANCES (UNLESS SPECIFIED)	DIMENSION STYLE	SCALE	DESIGN UNITS	THIRD ANGLE PROJECTION
	▽=0 ◻=0	mm INCH 4 PLACES ± --- ± --- 3 PLACES ± --- ± --- 2 PLACES ± --- ± --- 1 PLACE ± --- ± --- ANGULAR ± ---°	MM/IN	---	METRIC	
			DRAWN BY	DATE	TITLE	
			CHECKED BY	DATE	DMS59(M) TO DVI-I(F)+ VGA(F) ADAPTE CABLE	
			APPROVED BY	DATE	MOLEX MOLEX INCORPORATED	
		DRAFT WHERE APPLICABLE MUST REMAIN WITHIN DIMENSIONS		MATERIAL NO.	DOCUMENT NO.	SHEET NO.
				887685400	SD-88744-098	1 OF 2
		THIS DRAWING CONTAINS INFORMATION THAT IS PROPRIETARY TO MOLEX INCORPORATED AND SHOULD NOT BE USED WITHOUT WRITTEN PERMISSION				

6

5

4

3

2

1

WIRING DIAGRAM:

SHIELD	SHIELD	GROUND
C5	PIN 1,4,59	GROUND(RED, BLUE, GREEN)
C4	PIN 56	VGA1_HSYNC
C3	PIN 3	VGA1_BLUE
C2	PIN 58	VGA1_GREEN
C1	PIN 2	VGA1_RED
PIN 23	PIN 31	DVII_TXC+
PIN 24	PIN 32	DVII_TXC-
PIN 22	PIN 57	DVII_TXC RTN
PIN 19	PIN 33	DVII_TX0 RTN
PIN 18	PIN 29	DVII_TX0+
PIN 17	PIN 30	DVII_TX0-
PIN 16	PIN 36	DVII_HPD
PIN 15	PIN 54	GROUND
PIN 14	PIN 5	+5V
PIN 11	PIN 34	DVII_TX1 RTN
PIN 10	PIN 27	DVII_TX1+
PIN 9	PIN 28	DVII_TX1-
PIN 8	PIN 55	VGA1_VSYNC
PIN 7	PIN 7	DVII_DDC_DATA
PIN 6	PIN 6	DVII_DDC_CLOCK
PIN 3	PIN 35	DVII_TX2 RTN
PIN 2	PIN 25	DVII_TX2+
PIN 1	PIN 26	DVII_TX2-
DVI_I	DMS-59	CABLE FUNCTION

SHIELD	SHIELD	GROUND
PIN 15	PIN 10	VGA_SCL
PIN 14	PIN 51	VGA_VSYNC
PIN 13	PIN 50	VGA_HSYNC
PIN 12	PIN 9	VGA_SDA
PIN 10	PIN 52	GROUND(SYNCS)
PIN 9	PIN 11	+5V
PIN 8	PIN 12	GROUND(BLUE)
PIN 7	PIN 46	GROUND(GREEN)
PIN 6	PIN 15	GROUND(RED)
PIN 5	PIN 49	GROUND(ANALOG)
PIN 3	PIN 13	VGA_BLUE
PIN 2	PIN 47	VGA_GREEN
PIN 1	PIN 14	VGA_RED
VGA2	DMS-59	CABLE FUNCTION

NOTE:1. OVERMOLD SPECIFICATION

- 1.1 DMS-59 BOOT MOLDED WITH SNOW WHITE PVC RESIN, UL94V-0.
- 1.2 VGA BOOT MOLDED WITH BLUE PVC RESIN, UL94V-0.
- 1.3 DVI.I BOOT MOLDED WITH SNOW WHITE PVC RESIN: , UL94V-0.
- 2. MECHANICAL SPECIFICATION
 - ▽ 2.1 CABLE SHOULD STAND THE PULL FORCE 89-11IN FOR 30 SECONDS WITH NO VISIBLE TERMINATION DAMAGE.
 - 2.2 CABLE SHOULD PASS THE FLEX TEST IN 100 CYCLES AT EACH OF PLANES, PER EIA 364-41, CONDITION I.
- 3. CABLE ASSEMBLY ELECTRICAL SPECIFICATION
 - ▽ 3.1 HI-POT VOLTAGE: 300VDC FOR 10ms.
 - ▽ 3.2 INSULATION RESISTANCE: 20 MEGA Ohms PER MIN.
 - ▽ 3.3 CONNECTION RESISTANCE: 2 Ohms MAX.
 - ▽ 3.4 DIFFERENTIAL LINES CHARACTERISTIC IMPEDANCE: 100±7 Ohms. @TDR 200 PSEC RISETIME.
 - ▽ 3.5 COAXIAL LINES CHARACTERISTIC IMPEDANCE: 75±10% Ohms @TDR 200 PSEC RISETIME.
 - 3.6 WRAP COPPER TAPE OVER BRAID, THEN CRIMP THE METAL CAN ON COPPER TAPE WITH 360°.
- 4. CONNECTOR PLATING: GOLD FLASH PLATING.
- 5. SCREW SPEC.: 4-40 UNC.

MATERIAL LIST:

H	LABEL	I
G	VGA D-SUB CONNECTOR(FEMALE)	1
F	DVI(F) JACK SCREW	2
E	DVI.I FEMALE CONNECTOR	1
D	LFH THUMB SCREW 4-40 UNC	2
C	DMS-59 PLUG ASSY(NATURE)	1
B	DVI-A/D CABLE BLACK	1
A	DVI ANALOG CABLE BLACK	1
ITEM	DESCRIPTION	QTY.

ENTER DESCRIPTION EC NO: DG2006-0186 DRWN: PDAI CHKD: APPR: TKAN	2006/03/09 2006/03/09 2006/03/10	QUALITY SYMBOLS ▽=0 ▽=0	GENERAL TOLERANCES (UNLESS SPECIFIED)		DIMENSION STYLE	SCALE	DESIGN UNITS	THIRD ANGLE PROJECTION			
					MM/IN	---	METRIC				
					mm	INCH	DRAWN BY	DATE	TITLE		
					4 PLACES ±---	±---	PDAI	2006/03/07	DMS59(M) TO DVI-I(F)+ VGA(F) ADAPTE CABLE		
		3 PLACES ±---	±---	CHECKED BY	DATE						
		2 PLACES ±---	±---	ZXDENG	2006/03/07						
		1 PLACE ±---	±---	APPROVED BY	DATE						
		ANGULAR ±---°		BORON	2006/03/07	MOLEX MOLEX INCORPORATED					
		DRAFT WHERE APPLICABLE MUST REMAIN WITHIN DIMENSIONS		MATERIAL NO.	DOCUMENT NO.	SHEET NO.					
				887685400	SD-88744-098	2 OF 2					
				SIZE	THIS DRAWING CONTAINS INFORMATION THAT IS PROPRIETARY TO MOLEX INCORPORATED AND SHOULD NOT BE USED WITHOUT WRITTEN PERMISSION						
				A/4							