

**(SNAP-FIT PEG OPTION)**

SCALE: NTS  
SEE NOTE #8

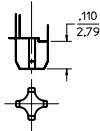

**(PRESS-FIT PEG OPTION)**

SCALE: NTS  
SEE NOTE #8

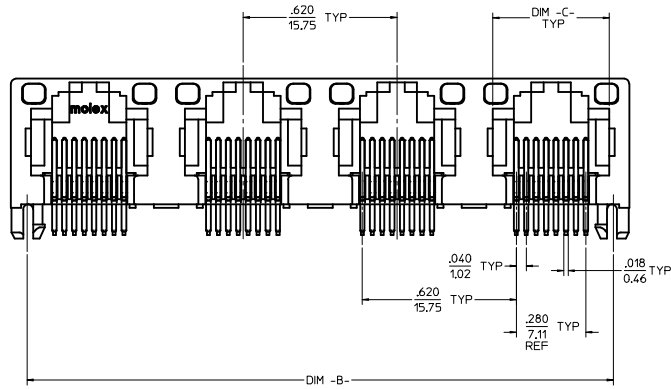
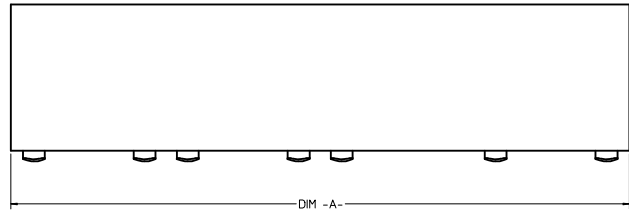

UNSHIELDED  
WITH LIGHT PIPES

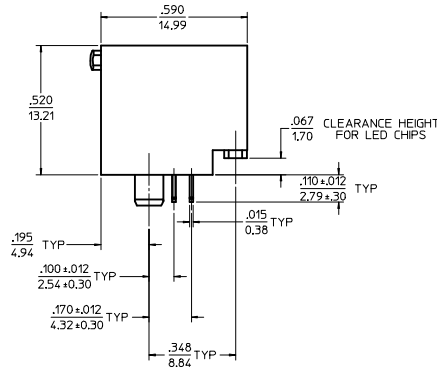

**8 CIRCUIT HOUSING(S)**

ASSEMBLY MATERIAL NUMBER	NUMBER OF CIRCUITS	NUMBER OF PORTS	PEG STYLE	DIM -A-	DIM -B-	DIM -C-
44248-0001	8	2	SNAP-FIT	1.250/31.75	1.120/28.45	.469/11.92
44248-0002	8	4	SNAP-FIT	2.490/63.25	2.360/59.94	.469/11.92
44248-0005	8	2	PRESS-FIT	1.250/31.75	1.120/28.45	.469/11.92
44248-0006	8	4	PRESS-FIT	2.490/63.25	2.360/59.94	.469/11.92

**6 CIRCUIT HOUSING(S)**

ASSEMBLY MATERIAL NUMBER	NUMBER OF CIRCUITS	NUMBER OF PORTS	PEG STYLE	DIM -A-	DIM -B-	DIM -C-
44248-0009	6	2	SNAP-FIT	1.250/31.75	1.120/28.45	.389/9.88
44248-0010	4	2	SNAP-FIT	1.250/31.75	1.120/28.45	.389/9.88
44248-0011	6	4	SNAP-FIT	2.490/63.25	2.360/59.94	.389/9.88
44248-0012	4	4	SNAP-FIT	2.490/63.25	2.360/59.94	.389/9.88
44248-0017	6	2	PRESS-FIT	1.250/31.75	1.120/28.45	.389/9.88
44248-0018	4	2	PRESS-FIT	1.250/31.75	1.120/28.45	.389/9.88
44248-0019	6	4	PRESS-FIT	2.490/63.25	2.360/59.94	.389/9.88
44248-0020	4	4	PRESS-FIT	2.490/63.25	2.360/59.94	.389/9.88

**NOTES:**

- 1) MATERIAL:  
HOUSING: POLYESTER(PBT), GLASS FILLED, UL94V-0, COLOR: BLACK  
LIGHT PIPES: POLYCARBONATE, UL-94V2, COLOR: CLEAR  
TERMINALS: PHOSPHOR BRONZE
- 2) FINISH:  
TERMINALS:  
SELECT GOLD IN CONTACT AREA: 50 MICRONCHES (127 MICROMETERS) MIN.  
SELECT TIN IN PC TAIL AREA: 100 MICRONCHES (254 MICROMETERS) MIN.  
WITH OVERALL NICKEL UNDERPLATE: 50 MICRONCHES (127 MICROMETERS) MIN.
- 3) PRODUCT SPECIFICATION AND PROCESSING PARAMETERS: PS-43860-003.
- 4) PACKAGING SPECIFICATION:  
CONNECTOR ASSEMBLIES IN THERMOFORMED TRAYS PER MOLEX PACKAGING SPECIFICATION PK-44248-004.
- 5) APPLICATION SPECIFICATION: AS-43860-001
- 6) ALL UNTOLERANCED DIMENSIONS ARE SHOWN FOR REFERENCE ONLY.
- 7) CONFORMS TO FCC REGULATION PART 68.5 FOR MODULAR JACKS.
- 8) MODJACKS AVAILABLE WITH EITHER SNAP-FIT OR PRESS-FIT PEGS.  
THIS DRAWING SHOWS SNAP-FIT PEGS.
- 9) PCB LAYOUT AND PANEL CUT-OUT SHOWN ON SHEETS (5) AND (6).
- 10) THIS PART CONFORMS TO CLASS B REQUIREMENTS OF COSMETIC SPECIFICATION PS-45499-002.

<b>ADD TAIL TOL</b> IEC NO: UCP2013-4879 DRAWN BY: DRW:WANGOVEN CHECKED BY: CHYD:IBELL APPROVED BY: APPR:PFMSMTH DATE: 2013/05/09 DATE: 2013/05/09 DATE: 2013/06/07	QUALITY SYMBOLS ∇=0 ∇=0 ∇=0	GENERAL TOLERANCES (UNLESS SPECIFIED): mm INCH 4 PLACES ±--- ±--- 3 PLACES ±--- ±.010 2 PLACES ±0.25 ±--- 1 PLACE ±--- ±--- 0 PLACE ± ±	DIMENSION STYLE IN/MM SCALE 4:1 DESIGN UNITS INCH THIRD ANGLE PROJECTION	DRAWN BY DATE M MAYO 98/10/06 CHECKED BY DATE J ROBERTS 98/10/06 APPROVED BY DATE J ROBERTS 98/10/06	TITLE GANGED INVERTED MODJACK ASSEMBLY	
	ANGULAR ±1/2° DRAFT WHERE APPLICABLE MUST REMAIN WITHIN DIMENSIONS		MATERIAL NO. SEE CHART	DOCUMENT NO. SD-44248-001	SHEET NO. 1 OF 6	
	THIS DRAWING CONTAINS INFORMATION THAT IS PROPRIETARY TO MOLEX INCORPORATED AND SHOULD NOT BE USED WITHOUT WRITTEN PERMISSION					
	SIZE D					

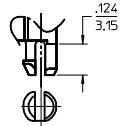

**SNAP-FIT PEG OPTION**

SCALE: NTS.  
SEE NOTE #8

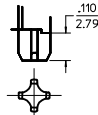

**PRESS-FIT PEG OPTION**

SCALE: NTS.  
SEE NOTE #8

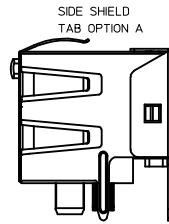

**SIDE SHIELD TAB OPTION B**

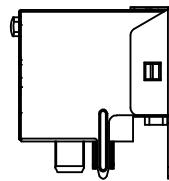

(8) CIRCUIT HOUSING(S)							
ASSEMBLY MATERIAL NUMBER	NUMBER OF CIRCUITS	NUMBER OF PORTS	PEG STYLE	SIDE SHIELD TAB OPTION	DIM -A-	DIM -B-	DIM -C-
44248-0029	8	2	SNAP-FIT	A	1.274/32.36	1.120/28.45	.469/11.92
44248-0030	8	4	SNAP-FIT	A	2.514/63.86	2.360/59.94	.469/11.92
44248-0033	8	2	PRESS-FIT	A	1.274/32.36	1.120/28.45	.469/11.92
44248-0034	8	4	PRESS-FIT	A	2.514/63.86	2.360/59.94	.469/11.92

(6) CIRCUIT HOUSING(S)							
ASSEMBLY MATERIAL NUMBER	NUMBER OF CIRCUITS	NUMBER OF PORTS	PEG STYLE	SIDE SHIELD TAB OPTION	DIM -A-	DIM -B-	DIM -C-
44248-0037	6	2	SNAP-FIT	A	1.274/32.36	1.120/28.45	.389/9.88
44248-0038	4	2	SNAP-FIT	A	1.274/32.36	1.120/28.45	.389/9.88
44248-0039	6	4	SNAP-FIT	A	2.514/63.86	2.360/59.94	.389/9.88
44248-0040	4	4	SNAP-FIT	A	2.514/63.86	2.360/59.94	.389/9.88
44248-0045	6	2	PRESS-FIT	A	1.274/32.36	1.120/28.45	.389/9.88
44248-0046	4	2	PRESS-FIT	A	1.274/32.36	1.120/28.45	.389/9.88
44248-0047	6	4	PRESS-FIT	A	2.514/63.86	2.360/59.94	.389/9.88
44248-0048	4	4	PRESS-FIT	A	2.514/63.86	2.360/59.94	.389/9.88

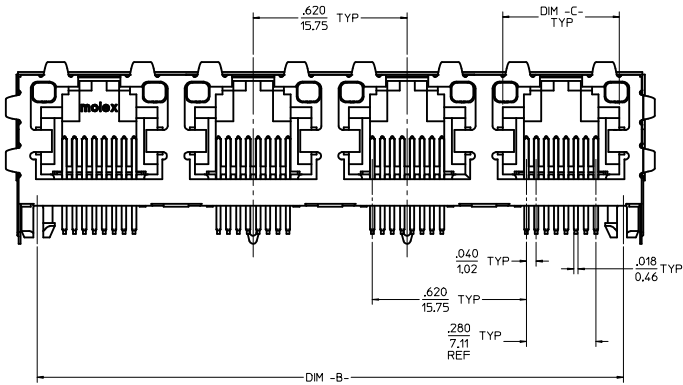
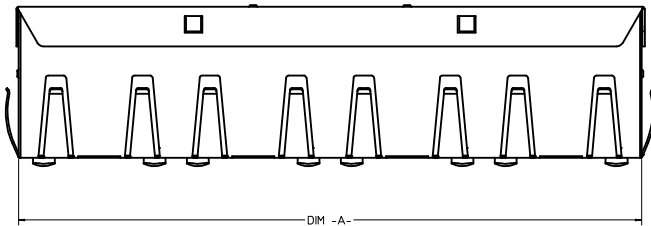

OPTIONAL SIDE SHIELD TABS SEE CHARTS

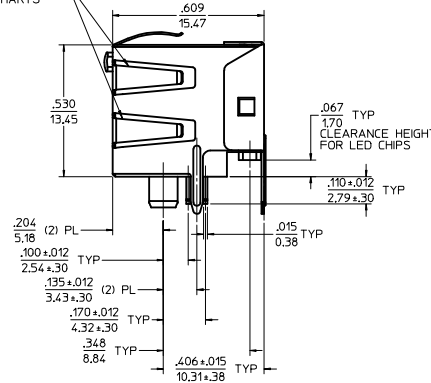

- NOTES:
- MATERIAL:  
HOUSING: POLYESTER(PBT), GLASS FILLED, UL94V-0, COLOR: BLACK  
LIGHT PIPES: POLYCARBONATE, UL-94V2, COLOR: CLEAR  
TERMINALS: PHOSPHOR BRONZE  
SHIELD: BRASS
  - FINISH:  
TERMINALS:  
SELECT GOLD IN CONTACT AREA: 50 MICRONS (1.27 MICROMETERS) MIN.  
SELECT TIN IN PC TAIL AREA: 100 MICRONS (2.54 MICROMETERS) MIN.  
WITH OVERALL NICKEL UNDERPLATE: 50 MICRONS (1.27 MICROMETERS) MIN.  
SHIELD:  
100 MICRONS (2.54 MICROMETERS) NICKEL OVER 50 MICRONS (1.27 MICROMETERS) COPPER UNDERPLATE PCB GROUND TABS DIPPED IN TIN
  - PRODUCT SPECIFICATION AND PROCESSING PARAMETERS: PS-43860-003.
  - PACKAGING SPECIFICATION:  
CONNECTOR ASSEMBLIES IN THERMOFORMED TRAYS PER MOLEX PACKAGING SPECIFICATION PK-44248-004.
  - APPLICATION SPECIFICATION: AS-43860-001
  - ALL UNTOLERANCED DIMENSIONS ARE SHOWN FOR REFERENCE ONLY.
  - CONFORMS TO FCC REGULATION PART 68.5 FOR MODULAR JACKS.
  - MODJACKS AVAILABLE WITH EITHER SNAP-FIT OR PRESS-FIT PEGS.  
THIS DRAWING SHOWS SNAP-FIT PEGS.
  - PCB LAYOUT AND PANEL CUT-OUT SHOWN ON SHEETS (5) AND (6).
  - THIS PART CONFORMS TO CLASS B REQUIREMENTS OF COSMETIC SPECIFICATION PS-45499-002.

SHIELDED WITH LIGHT PIPES

SEE SHEET 1 IEC NO: UCP2013-4879 DRAWN BY: CHYD.BELL CHECKED BY: APPR:FSMTH DATE: 2013/05/09 DATE: 2013/06/07	QUALITY SYMBOLS	GENERAL TOLERANCES (UNLESS SPECIFIED):	DIMENSION STYLE: IN/MM	SCALE: 4:1	DESIGN UNITS: INCH	THIRD ANGLE PROJECTION	
	∇=0 ∇=0 ∇=0	4 PLACES ± .mm 3 PLACES ± .010 2 PLACES ± 0.25 1 PLACE ± 0 PLACE ±	± .mm ± .010 ± .025 ± ±	DRAWN BY: MMAYO CHECKED BY: JROBERTS APPROVED BY: JROBERTS DATE: 98/10/06 DATE: 98/10/06 DATE: 98/10/06	TITLED: <b>GANGED INVERTED MODJACK ASSEMBLY</b> <b>molex</b> DOCUMENT NO: <b>SD-44248-001</b>		
	DRAFT WHERE APPLICABLE MUST REMAIN WITHIN DIMENSIONS		ANGULAR ±1/2° SEE CHART	MATERIAL NO. _____ SHEET NO. <b>2 OF 6</b>			
	THIS DRAWING CONTAINS INFORMATION THAT IS PROPRIETARY TO MOLEX INCORPORATED AND SHOULD NOT BE USED WITHOUT WRITTEN PERMISSION						

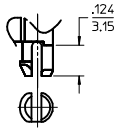

**SNAP-FIT PEG OPTION**

SCALE: NTS.  
SEE NOTE #7

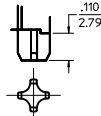

**PRESS-FIT PEG OPTION**

SCALE: NTS.  
SEE NOTE #7



**8 CIRCUIT HOUSING(S)**

ASSEMBLY MATERIAL NUMBER	NUMBER OF CIRCUITS	NUMBER OF PORTS	PEG STYLE	DIM -A-	DIM -B-	DIM -C-
44248-0057	8	2	SNAP-FIT	1.250/31.75	1.120/28.45	.469/11.92
44248-0058	8	4	SNAP-FIT	2.490/63.25	2.360/59.94	.469/11.92
44248-0061	8	2	PRESS-FIT	1.250/31.75	1.120/28.45	.469/11.92
44248-0062	8	4	PRESS-FIT	2.490/63.25	2.360/59.94	.469/11.92

**6 CIRCUIT HOUSING(S)**

ASSEMBLY MATERIAL NUMBER	NUMBER OF CIRCUITS	NUMBER OF PORTS	PEG STYLE	DIM -A-	DIM -B-	DIM -C-
44248-0065	6	2	SNAP-FIT	1.250/31.75	1.120/28.45	.389/9.88
44248-0066	4	2	SNAP-FIT	1.250/31.75	1.120/28.45	.389/9.88
44248-0067	6	4	SNAP-FIT	2.490/63.25	2.360/59.94	.389/9.88
44248-0068	4	4	SNAP-FIT	2.490/63.25	2.360/59.94	.389/9.88
44248-0073	6	2	PRESS-FIT	1.250/31.75	1.120/28.45	.389/9.88
44248-0074	4	2	PRESS-FIT	1.250/31.75	1.120/28.45	.389/9.88
44248-0075	6	4	PRESS-FIT	2.490/63.25	2.360/59.94	.389/9.88
44248-0076	4	4	PRESS-FIT	2.490/63.25	2.360/59.94	.389/9.88

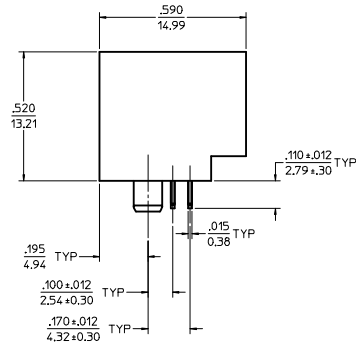
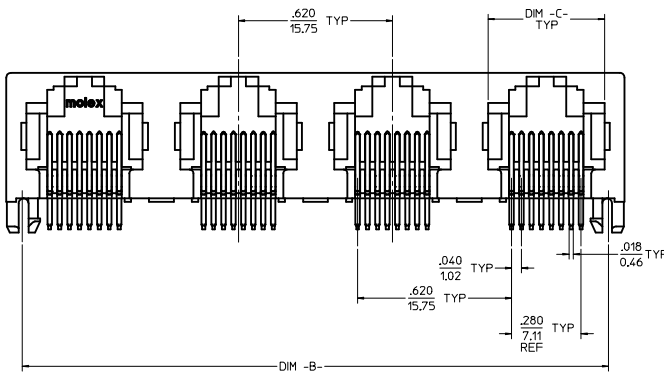

- NOTES:  
 1) MATERIAL:  
 HOUSING: POLYESTER(PBT), GLASS FILLED, UL94V-0, COLOR: BLACK  
 TERMINALS: PHOSPHOR BRONZE  
 2) FINISH:  
 TERMINALS:  
 SELECT GOLD IN CONTACT AREA: 50 MICROINCHES (127 MICROMETERS) MIN.  
 SELECT TIN IN PC TAIL AREA: 100 MICROINCHES (2.54 MICROMETERS) MIN.  
 WITH OVERALL NICKEL UNDERPLATE: 50 MICROINCHES (127 MICROMETERS) MIN.  
 3) PRODUCT SPECIFICATION AND PROCESSING PARAMETERS: PS-43860-003.  
 4) PACKAGING SPECIFICATION:  
 CONNECTOR ASSEMBLIES IN THERMOFORMED TRAYS PER MOLEX PACKAGING SPECIFICATION PK-44248-004.  
 5) ALL UNTOLERANCED DIMENSIONS ARE SHOWN FOR REFERENCE ONLY.  
 6) CONFORMS TO FCC REGULATION PART 68.5 FOR MODULAR JACKS.  
 7) MODJACKS AVAILABLE WITH EITHER SNAP-FIT OR PRESS-FIT PEGS.  
 THIS DRAWING SHOWS SNAP-FIT PEGS.  
 8) PCB LAYOUT AND PANEL CUT-OUT SHOWN ON SHEETS (5) AND (6).  
 9) THIS PART CONFORMS TO CLASS B REQUIREMENTS OF COSMETIC SPECIFICATION PS-45499-002.

UNSHIELDED

SEE SHEET 1 IEC NO: UCP2013-4879 DRAWN: WANGWEN 2013/05/09 CHKD: J.BELL 2013/05/09 APPR: F.S.MITH 2013/06/07	QUALITY SYMBOLS	GENERAL TOLERANCES (UNLESS SPECIFIED)	DIMENSION STYLE	SCALE	DESIGN UNITS	THIRD ANGLE PROJECTION	
	∇=0 ∇=0 ∇=0	mm INCH 4 PLACES ± --- ± --- 3 PLACES ± --- ± .010 2 PLACES ± 0.25 ± --- 1 PLACE ± --- ± --- 0 PLACE ± --- ± ---	IN/MM DRAWN BY DATE MMAYO 98/10/06 CHECKED BY DATE J.ROBERTS 98/10/06 APPROVED BY DATE J.ROBERTS 98/10/06	4:1 TITLE GANGED INVERTED MODJACK ASSEMBLY	MATERIAL NO. SEE CHART	DOCUMENT NO. SD-44248-001	SHEET NO. 3 OF 6
	ANGULAR ±1/2° DRAFT WHERE APPLICABLE MUST REMAIN WITHIN DIMENSIONS						THIS DRAWING CONTAINS INFORMATION THAT IS PROPRIETARY TO MOLEX INCORPORATED AND SHOULD NOT BE USED WITHOUT WRITTEN PERMISSION
	moxle						

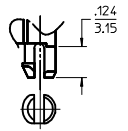

**SNAP-FIT PEG OPTION**

SCALE: NTS. SEE NOTE #7

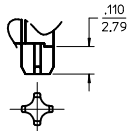

**PRESS-FIT PEG OPTION**

SCALE: NTS. SEE NOTE #7

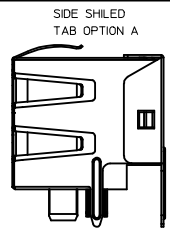

SIDE SHIELDED TAB OPTION A

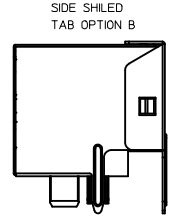

SIDE SHIELDED TAB OPTION B

(8) CIRCUIT HOUSING(S)								
X = NOT TOOLED	ASSEMBLY MATERIAL NUMBER	NUMBER OF CIRCUITS	NUMBER OF PORTS	PEG STYLE	SIDE SHIELD TAB OPTION	DIM -A-	DIM -B-	DIM -C-
	44248-0085	8	2	SNAP-FIT	A	1.274/32.36	1.120/28.45	.469/11.92
	44248-0086	8	4	SNAP-FIT	A	2.514/63.86	2.360/59.94	.469/11.92
	44248-0089	8	2	PRESS-FIT	A	1.274/32.36	1.120/28.45	.469/11.92
	44248-0090	8	4	PRESS-FIT	A	2.514/63.86	2.360/59.94	.469/11.92
X	44248-0119	8	8	PRESS FIT	B	2.514/63.86	2.360/59.94	.469/11.92

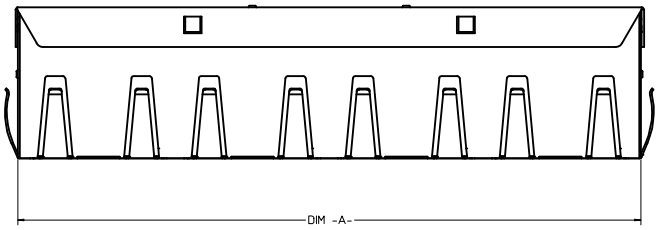

(6) CIRCUIT HOUSING(S)								
ASSEMBLY MATERIAL NUMBER	NUMBER OF CIRCUITS	NUMBER OF PORTS	PEG STYLE	SIDE SHIELD TAB OPTION	DIM -A-	DIM -B-	DIM -C-	
44248-0093	6	2	SNAP-FIT	A	1.274/32.36	1.120/28.45	.389/9.88	
44248-0094	4	2	SNAP-FIT	A	1.274/32.36	1.120/28.45	.389/9.88	
44248-0095	6	4	SNAP-FIT	A	2.514/63.86	2.360/59.94	.389/9.88	
44248-0096	4	4	SNAP-FIT	A	2.514/63.86	2.360/59.94	.389/9.88	
44248-0101	6	2	PRESS-FIT	A	1.274/32.36	1.120/28.45	.389/9.88	
44248-0102	4	2	PRESS-FIT	A	1.274/32.36	1.120/28.45	.389/9.88	
44248-0103	6	4	PRESS-FIT	A	2.514/63.86	2.360/59.94	.389/9.88	
44248-0104	4	4	PRESS-FIT	A	2.514/63.86	2.360/59.94	.389/9.88	

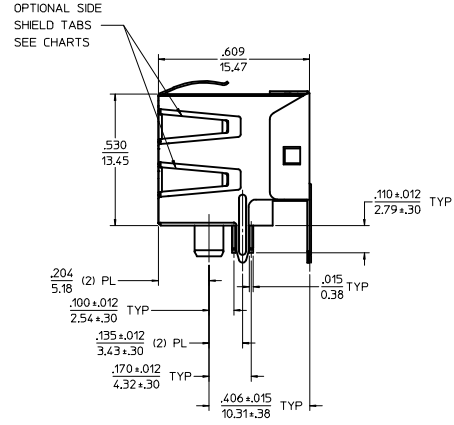
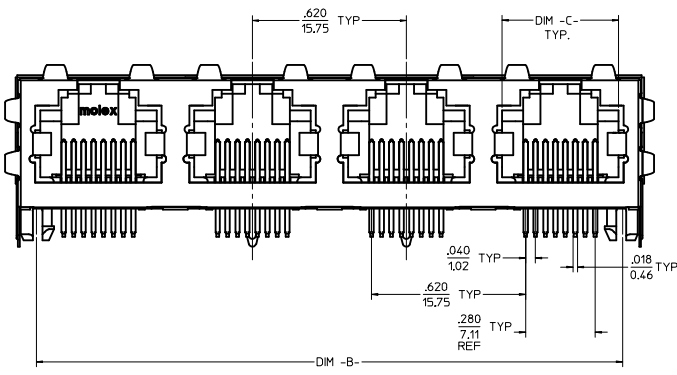

OPTIONAL SIDE SHIELD TABS SEE CHARTS

- NOTES:
- MATERIAL: HOUSING: POLYESTER(PBT), GLASS FILLED, UL94V-0, COLOR: BLACK  
TERMINALS: PHOSPHOR BRONZE  
SHIELD: BRASS
  - FINISH: SELECT GOLD IN CONTACT AREA: 50 MICRONS (1.27 MICROMETERS) MIN., SELECT TIN IN PC TAIL AREA: 100 MICRONS (2.54 MICROMETERS) MIN., WITH OVERALL NICKEL UNDERPLATE: 50 MICRONS (1.27 MICROMETERS) MIN.  
SHIELD: 100 MICRONS (2.54 MICROMETERS) NICKEL OVER 50 MICRONS (1.27 MICROMETERS) COPPER UNDERPLATE PCB GROUND TABS DIPPED IN TIN
  - PRODUCT SPECIFICATION AND PROCESSING PARAMETERS: PS-43860-003.
  - PACKAGING SPECIFICATION: CONNECTOR ASSEMBLIES IN THERMOFORMED TRAYS PER MOLEX PACKAGING SPECIFICATION PK-44248-004.
  - ALL UNTOLERANCED DIMENSIONS ARE SHOWN FOR REFERENCE ONLY. CONFORMS TO FCC REGULATION PART 68.5 FOR MODULAR JACKS.
  - MODJACKS AVAILABLE WITH EITHER SNAP-FIT OR PRESS-FIT PEGS. THIS DRAWING SHOWS SNAP-FIT PEGS.
  - PCB LAYOUT AND PANEL CUT-OUT SHOWN ON SHEETS (5) AND (6).
  - THIS PART CONFORMS TO CLASS B REQUIREMENTS OF COSMETIC SPECIFICATION PS-45499-002.

SHIELDED

SEE SHEET 1 ILEC NO: UCP2013-4879 DRAWN BY: DRYNANNGUEN 2013/05/09 CHYD.BELL 2013/05/09 APPROVED BY: APPREHENSITH 2013/06/07	QUALITY SYMBOLS ∇=0 ∇=0 ∇=0	GENERAL TOLERANCES (UNLESS SPECIFIED) mm INCH 4 PLACES ±.--- ±.--- 3 PLACES ±.--- ±.010 2 PLACES ±0.25 ±.--- 1 PLACE ±.--- ±.--- 0 PLACE ±.--- ±.---	DIMENSION STYLE IN/MM DRAWN BY: MMAYO DATE: 98/10/06 CHECKED BY: JROBERTS DATE: 98/10/06 APPROVED BY: JROBERTS DATE: 98/10/06	SCALE: 4:1 DESIGN UNITS: INCH THIRD ANGLE PROJECTION	TITLE: GANGED INVERTED MODJACK ASSEMBLY
		ANGULAR ±1/2° DRAFT WHERE APPLICABLE MUST REMAIN WITHIN DIMENSIONS	MATERIAL NO: SEE CHART	DOCUMENT NO: SD-44248-001	SHEET NO: 4 OF 6

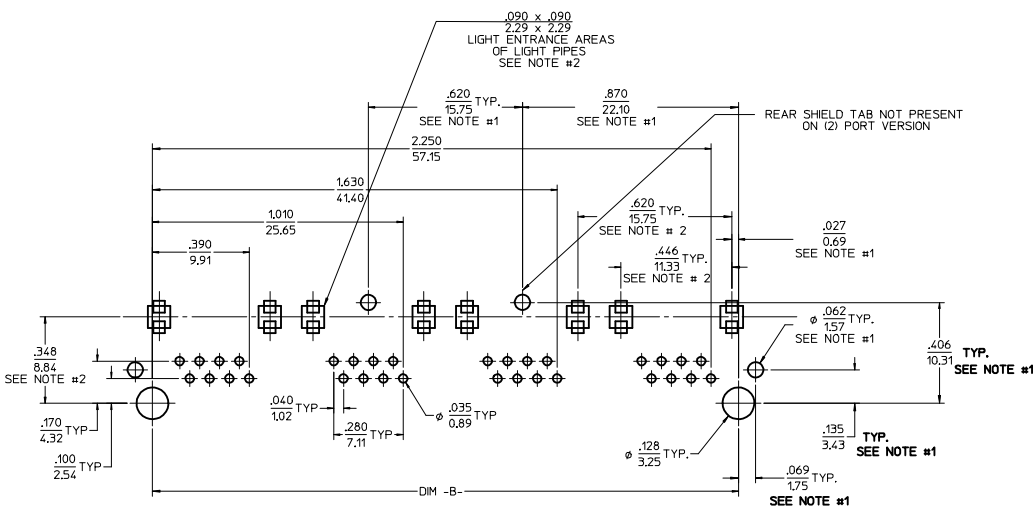

8 CIRCUIT PCB LAYOUT: COMPONENT SIDE  
 RECOMMENDED PCB THICKNESS: .062/157  
 TOLERANCE  $\pm .003/.076$  UNLESS OTHERWISE SPECIFIED

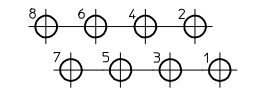
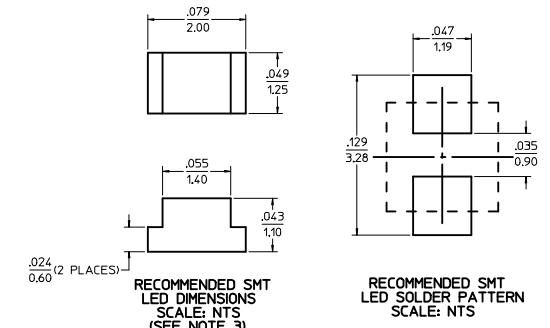

TYPICAL PC TERMINAL HOLE LAYOUT  
 (8) CIRCUIT CONFIGURATION  
 SCALE: 10:1

- NOTES:
- 1) DIMENSIONS MARKED "SEE NOTE #1" REFER TO ASSEMBLIES WITH THE SHIELDING OPTION INCLUDED
  - 2) DIMENSIONS MARKED "SEE NOTE #2" REFER TO ASSEMBLIES WITH THE LIGHT PIPE OPTION INCLUDED
  - 3) FOR CROSS REFERENCE OF RECOMMENDED LEADS SEE MOLEX WEB SITE.

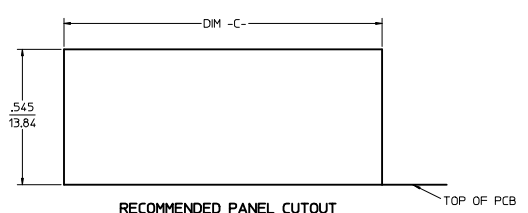

NUMBER OF PORTS	DIM -B-	DIM -C-
2	1.120/28.45	1.280/32.51
4	2.360/59.94	2.520/64.01

SEE SHEET 1 IEC NO: LUCP2013-4879 DRAWN BY: CHYKJIBELL CHECKED BY: CHYKJIBELL APPROVED BY: APPR:FSM:TH 2013/05/09 2013/05/09 2013/06/07	QUALITY SYMBOLS	GENERAL TOLERANCES (UNLESS SPECIFIED)	DIMENSION STYLE	SCALE	DESIGN UNITS	THIRD ANGLE PROJECTION	
	$\nabla=0$ $\nabla=0$ $\nabla=0$	4 PLACES $\pm$ --- $\pm$ INCH 3 PLACES $\pm$ --- $\pm$ .010 2 PLACES $\pm$ 0.25 $\pm$ --- 1 PLACE $\pm$ --- $\pm$ --- 0 PLACE $\pm$ --- $\pm$ ---	IN/MM 4:1 INCH	DRAWN BY: MMAYO DATE: 98/10/06 CHECKED BY: JROBERTS DATE: 98/10/06 APPROVED BY: JROBERTS DATE: 98/10/06			
	DRAFT WHERE APPLICABLE MUST REMAIN WITHIN DIMENSIONS ANGULAR $\pm 1/2^\circ$	MATERIAL NO: N/A DOCUMENT NO: SD-44248-001					TITLE: GANGED INVERTED MODJACK ASSEMBLY SHEET NO: 5 OF 6

