

TABLE OF CONTENTS	
SHEET NO.	SHEET DESCRIPTION
1	NOTES AND BOM
2	CONFIGURATIONS
3-4	KEY CONFIGURATIONS
5	BLADE SEALED ASSEMBLY
6	SYSTEM PACKAGING
7	BACKSHELL NOTES
8	BACKSHELL
9	BACKSHELL CONFIGURATIONS

NOTES: VALID UNLESS OTHERWISE SPECIFIED

1. GENERAL:
 a. APPLICATION SPECIFICATION SEE: AS-33472-100
 -CONTAINS: PRODUCT INTRODUCTION, PRODUCT SUMMARY, CONNECTOR ASSEMBLY, PACKAGING INFORMATION, CONNECTOR MATING, SERVICE INSTRUCTIONS, ELECTRICAL CONTINUITY CHECKING, CRIMPING, AND TROUBLESHOOTING.
 -DESIGNED TO MATE WITH RECEPTACLE SEALED ASSEMBLY AS SPECIFIED IN THE MATING CONNECTOR DRAWINGS CHART.
 +DENOTES DRAWINGS THAT CAN BE ACCESSED AT <http://ewcap.uscarteams.org/>.
 -ASSEMBLY SHIPPED WITH PLR IN PRE-LOCK POSITION (SEE PLR PRE-LOCK VIEW SHEET 5).

MATING CONNECTOR DRAWINGS	
DESCRIPTION	MOLEX INLINE
2X2	SD-33472-0001
2X3	SD-33472-0001
2X4	SD-33472-0001
2X6	SD-33472-0001
2X8	SD-33472-0001
2X10	SD-33472-0001

b. PRODUCT SPECIFICATION SEE:
 -STANDARD CONFIGURATION: PS-33472-000
 -UL V0 CONFIGURATION: TBD
 CONTAINS: PRODUCT INTRODUCTION, PRODUCT SUMMARY, RATINGS (CURRENT, TEMPERATURE, SEALING, AND FLAMMABILITY), TERMINALS, WIRE DIAMETER RANGE, PRODUCT VALIDATION, AND PRODUCT DEVIATIONS.

c. PACKAGING SPECIFICATION PER MOLEX DRAWING: PK-31300-635

d. PARTS MUST BE IN COMPLIANCE TO MOLEX CHEMICAL SUBSTANCES FOR PRODUCTS AND PACKAGING SPECIFICATION: QEHS-699000-300

e. DATA MUST BE SUBMITTED UNDER THE MOLEX PART NUMBER TO IMS (COMPANY ID#13255)

2. DESIGN - MATERIALS:
 a. FOR BILL OF MATERIALS SEE:
 -STANDARD CONFIGURATION: SD-33482-0002
 -UL V0 CONFIGURATION: SD-160084-0002

3. DESIGN - GEOMETRY:
 a. THE 3-D CAD DATA IS BASIC (WITHOUT TOLERANCE) AND MASTER FOR THIS PART WITH THE EXCEPTION OF UNDERLINED DIMENSIONS. DIMENSIONAL INFORMATION NOT SHOWN ON THIS DRAWING IS DEFINED BY THE DATA FILE AT ITS LATEST REVISION.
 b. GEOMETRIC DIMENSIONS AND TOLERANCES PER ASME Y14.5M-2009
 c. EDGES AND UNDIMENSIONED DETAILS PER ISO13715
 d. CORNERS SHOWN AS SHARP TO BE R 0.2 MAX.
 e. LETTERING SHALL BE 0.15 MAX RAISED IN 0.25 MAX RECESS PAD. THIS INCLUDES RECYCLING CODE, CAVITY ID, VENDOR IDENTIFICATION, AND CUSTOMER MATERIAL NUMBER.
 f. VISUAL DEFECTS SHALL MEET COSMETIC STANDARD PS-45499-002 (Class B).
 g. LASER MARKING:
 1. PART NUMBER
 2. DAY OF THE YEAR
 3. SHIFT
 4. YEAR
 FOR ADDITIONAL INFORMATION SEE SECTION 5 UNDER PROCEDURES IN ES-34735-008.

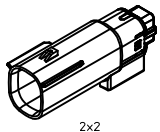

2x2

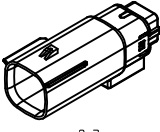

2x3

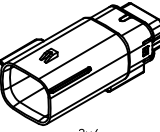

2x4

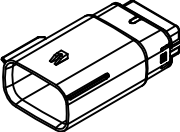

2x6

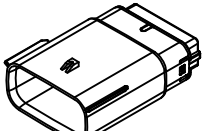

2x8

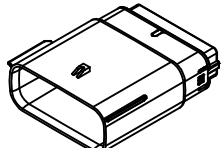

2x10

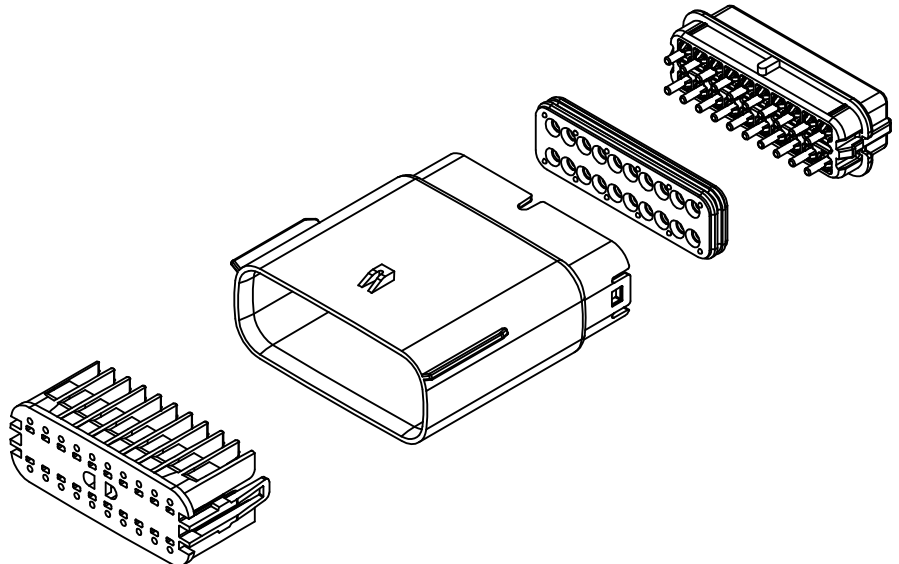

REV	REV DESCRIPTION
D	MINOR GEOMETRY CHANGE FOR UL V0
C3	ADD 2X4
C2	ADD 2X3
C1	ADD UL V0 CONFIGURATIONS
C	ADD 2X8
B1	ADD 2X6 BACKSHELL INFO
B	ADD 2X6
A	INITIAL RELEASE

INSPECTION NUMBER LOG
LAST NUMBER: 9
ADDED:
REMOVED:

ENTER DESCRIPTION EEC NO: UAUZ016-1539 DRWNB/BTANG 2016/05/16 CHKD: APPR:KDEKOSKI 2016/05/24	QUALITY SYMBOLS	GENERAL TOLERANCES (UNLESS SPECIFIED)	DIMENSION STYLE MM ONLY	DRAWN BY DATE	TITLE
	▽=0	4 PLACES ± --- ± ---	APPROFIT T 2014/04/28	MX150 BLADE DUAL ROW SEALED ASSEMBLY MAT SEAL molex DOCUMENT NO. SD-33482-0001 SHEET NO. 1 OF 9	
	▽=0	3 PLACES ± --- ± ---	CHECKED BY DATE		
	▽=0	2 PLACES ± 0.10 ± ---	KBORUSZEWSKI 2014/04/29		
▽=0	1 PLACE ± 0.2 ± ---	APPROVED BY DATE			
▽=0	0 PLACE ± --- ± ---	ANGULAR ± 1 °	VKOSHY 2014/05/14	SEE NOTE 2a.	
DRAFT WHERE APPLICABLE MUST REMAIN WITHIN DIMENSIONS		MATERIAL NO.		THIS DRAWING CONTAINS INFORMATION THAT IS PROPRIETARY TO MOLEX AND SHOULD NOT BE USED WITHOUT WRITTEN PERMISSION	

SHEET DESCRIPTION

CONFIGURATIONS

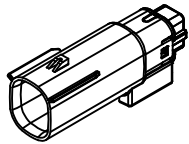

2X2 - STANDARD (STD)

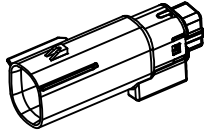

2X2 - UL V0+

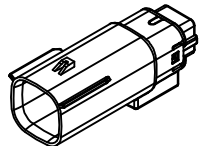

2X3 - STANDARD (STD)

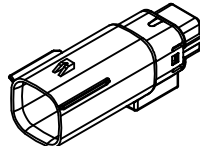

2X3 - LENGTHENED

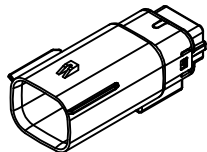

2X4 - STANDARD (STD)

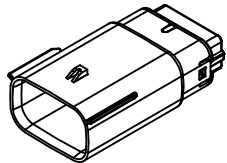

2X6 - STANDARD (STD)

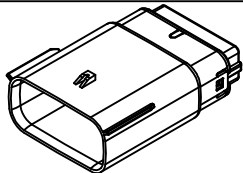

2X8 - STANDARD (STD)

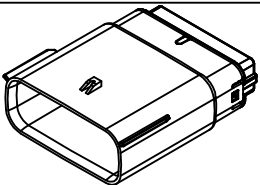

2X10 - STANDARD (STD)

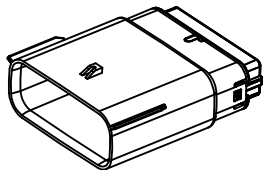

2X10 - UL V0+

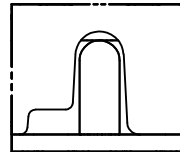

UL V0 UNIQUE FEATURE

Partial1
SCALE 10:1

* MINOR GEOMETRY CHANGE THAN STANDARD CONFIGURATION.
SEE NOTE 2a FOR MORE INFORMATION

ENTER DESCRIPTION EC NO: UAU2016-1539 DRWN:BTANG 2016/05/16 CHKD: APPR:KDEKOSKI 2016/05/24 REV:	QUALITY SYMBOLS	GENERAL TOLERANCES (UNLESS SPECIFIED)	DIMENSION STYLE MM ONLY	SCALE 1.5:1	DESIGN UNITS METRIC	THIRD ANGLE PROJECTION
	▽=0	4 PLACES ± --- ± ---	DRAWN BY DATE APPROFIT 2014/04/28	TITLE MX150 BLADE DUAL ROW SEALED ASSEMBLY MAT SEAL		
	▽=0	3 PLACES ± --- ± ---	CHECKED BY DATE KBORUSZEWSKI 2014/04/29			
	▽=0	2 PLACES ± 0.10 ± ---	APPROVED BY DATE VKOSHY 2014/05/14	DOCUMENT NO. SD-33482-0001	SHEET NO. 2 OF 9	
	ANGULAR ± 1 °	DRAFT WHERE APPLICABLE MUST REMAIN WITHIN DIMENSIONS	SEE NOTE 2a.	THIS DRAWING CONTAINS INFORMATION THAT IS PROPRIETARY TO MOLEX INCORPORATED AND SHOULD NOT BE USED WITHOUT WRITTEN PERMISSION		

SHEET DESCRIPTION

KEY CONFIGURATIONS

2X2

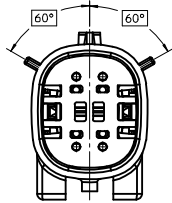

KEY A

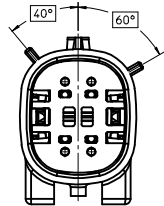

KEY B

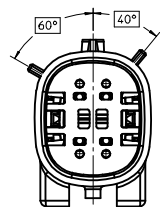

KEY C

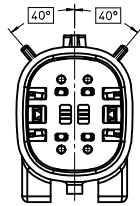

KEY D

2X3

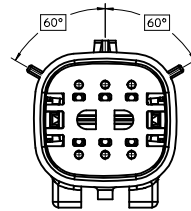

KEY A

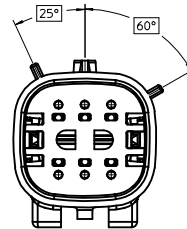

KEY B

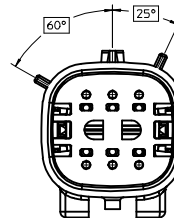

KEY C

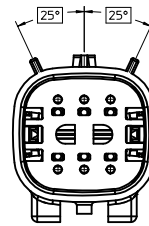

KEY D

2X4

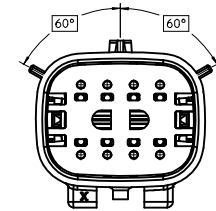

KEY A

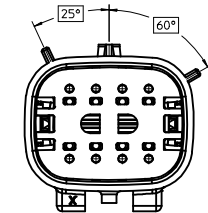

KEY B

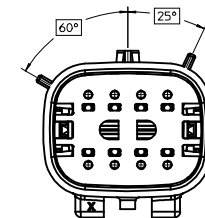

KEY C

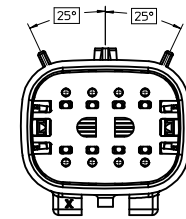

KEY D

ENTER DESCRIPTION EEC NO: UAU2016-1539 D DRYN&BTANG 2016/05/16 CHKD: APPR:KCEKOSKI 2016/05/24	QUALITY SYMBOLS ▽=0 ▽=0.10 ▽=0.2	GENERAL TOLERANCES (UNLESS SPECIFIED)		DIMENSION STYLE MM ONLY	SCALE 3:1	DESIGN UNITS METRIC	THIRD ANGLE PROJECTION
		4 PLACES ± --- ± --- 3 PLACES ± --- ± --- 2 PLACES ± 0.10 ± --- 1 PLACE ± 0.2 ± --- 0 PLACE ± --- ± ---	mm INCH ± --- ± --- ± 0.10 ± --- ± 0.2 ± --- ± --- ± ---	DRAWN BY APROFFITT DATE 2014/04/28	CHECKED BY KBORUSZEWSKI DATE 2014/04/29	APPROVED BY VKOSHY DATE 2014/05/14	MATERIAL NO. SEE NOTE 2a.
DRAFT WHERE APPLICABLE MUST REMAIN WITHIN DIMENSIONS		ANGULAR ± 1 °		THIS DRAWING CONTAINS INFORMATION THAT IS PROPRIETARY TO MOLEX INCORPORATED AND SHOULD NOT BE USED WITHOUT WRITTEN PERMISSION			

SHEET DESCRIPTION
KEY CONFIGURATIONS CONT.

2X6

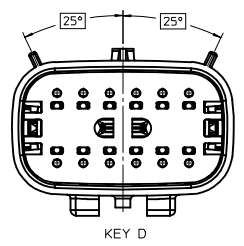
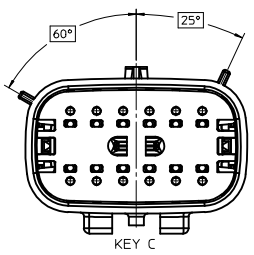
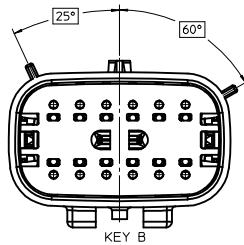
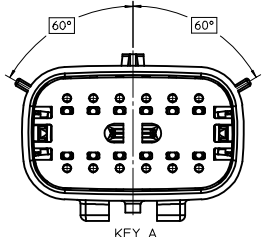

2X8

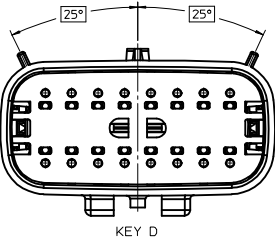
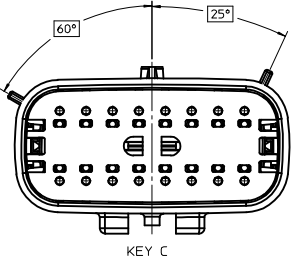
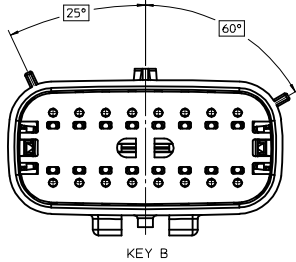
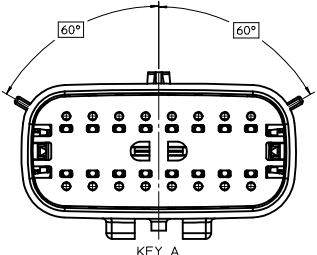

2X10

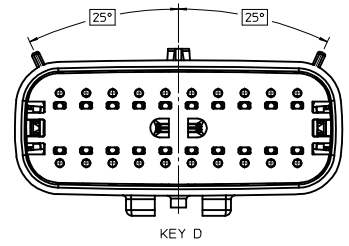
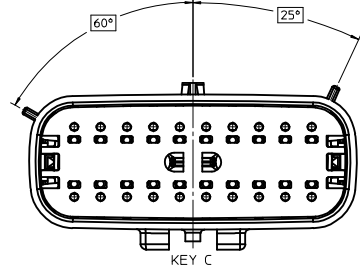
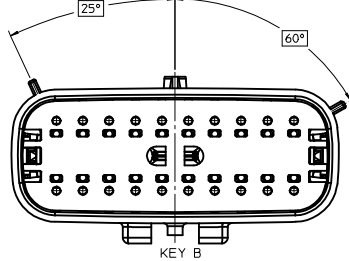
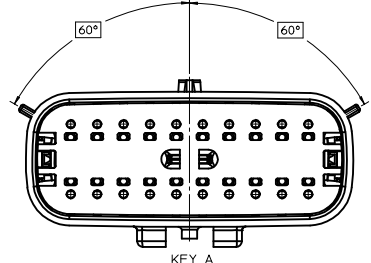

ENTER DESCRIPTION EC NO: UAU2016-1539 DORWAIBTANG 2016/05/16 CHKD: APPR:KDEKOSKI 2016/05/24	QUALITY SYMBOLS ▽=0 ▽=0 ▽=0	GENERAL TOLERANCES (UNLESS SPECIFIED)		DIMENSION STYLE MM ONLY	SCALE 3:1	DESIGN UNITS METRIC	THIRD ANGLE PROJECTION
		4 PLACES ± --- ± --- 3 PLACES ± --- ± --- 2 PLACES ± 0.10 ± --- 1 PLACE ± 0.2 ± --- 0 PLACE ± --- ± ---	mm INCH ANGULAR ± 1 °	DRAWN BY DATE APPROFIT 2014/04/28 CHECKED BY DATE KBORUSZEWSKI 2014/04/29 APPROVED BY DATE VKOSHY 2014/05/14	MATERIAL NO. SEE NOTE 2a.	TITLE MX150 BLADE DUAL ROW SEALED ASSEMBLY MAT SEAL molex	DOCUMENT NO. SD-33482-0001
DRAFT WHERE APPLICABLE MUST REMAIN WITHIN DIMENSIONS		THIS DRAWING CONTAINS INFORMATION THAT IS PROPRIETARY TO MOLEX INCORPORATED AND SHOULD NOT BE USED WITHOUT WRITTEN PERMISSION					

SHEET DESCRIPTION

BLADE SEALED ASSEMBLY

CHARTED DIMENSIONS

DESCRIPTION	DIMENSIONS				
	A	B	C	D	E
2X2	15.54	1.75	24.40	54.45	22.23
2X3 STANDARD	19.04	3.50	26.21	54.45	22.23
2X3 LENGTHENED	19.04	3.50	26.21	56.45	22.23
2X4	22.54	1.75	27.21	54.45	22.23
2X6	29.54	1.75	32.27	54.45	22.23
2X8	36.54	1.75	38.88	54.45	22.23
2X10	43.64	1.75	45.65	54.45	22.05

OPTIONAL LASER MARKING ON THIS SURFACE SEE NOTE 3g.

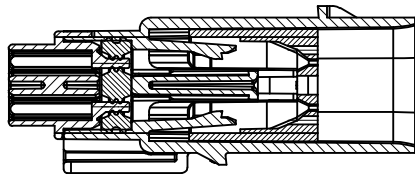
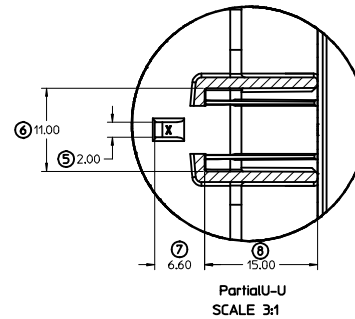
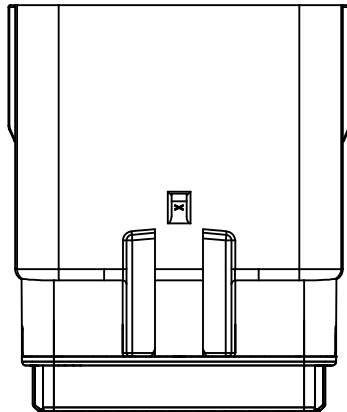
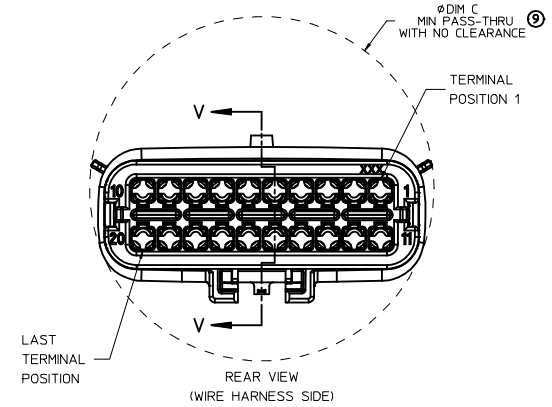
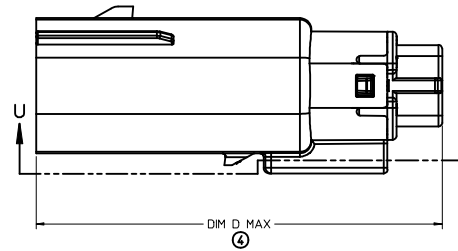
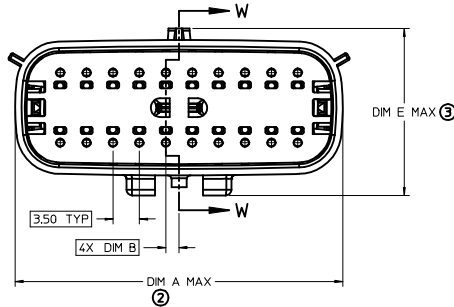
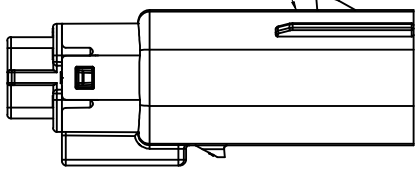

PRIMARY LOCK REINFORCEMENT (PLR) SHOWN IN PRE-STAGED POSITION
SECTION W-W

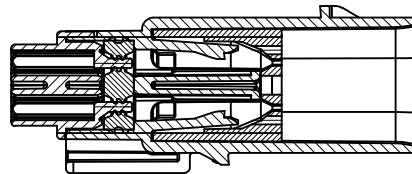

PRIMARY LOCK REINFORCEMENT (PLR) SHOWN IN FINAL-LOCK POSITION
SECTION V-V

ENTER DESCRIPTION EEC NO: UAU2016-0539 D DRYNGBANG 2016/05/16 CHYK: APPR:KEKOSKI 2016/05/24	QUALITY SYMBOLS ∇=0 ∇=1 ∇=2	GENERAL TOLERANCES (UNLESS SPECIFIED)		DIMENSION STYLE MM ONLY	SCALE 3:1	DESIGN UNITS METRIC	THIRD ANGLE PROJECTION		
		4 PLACES ± --- ± ---	3 PLACES ± --- ± ---	2 PLACES ± 0.10 ± ---	1 PLACE ± 0.2 ± ---	0 PLACE ± --- ± ---	DRAWN BY APROFFITT DATE 2014/04/28	CHECKED BY KBORUSZEWSKI DATE 2014/04/29	APPROVED BY VKOSHY DATE 2014/05/14
		ANGULAR ± 1 °		DRAFT WHERE APPLICABLE MUST REMAIN WITHIN DIMENSIONS		MATERIAL NO. SEE NOTE 2a.	DOCUMENT NO. SD-33482-0001	SHEET NO. 5 OF 9	
		THIS DRAWING CONTAINS INFORMATION THAT IS PROPRIETARY TO MOLEX INCORPORATED AND SHOULD NOT BE USED WITHOUT WRITTEN PERMISSION							

SHEET DESCRIPTION

SYSTEM PACKAGING

CHARTED DIMENSIONS				
CKT	BLADE CONFIGURATION	RECEPTACLE CONFIGURATION	DIMENSIONS	
			K	L
2X2	STANDARD	STANDARD	72.78	28.00
		LENGTHENED	77.21	
2X3	STANDARD	W/O CLIPSLOT	72.78	30.50
		W/ CLIPSLOT		28.00
	LENGTHENED	W/O CLIPSLOT	74.79	30.50
		W/ CLIPSLOT		28.00
2X4	STANDARD	STANDARD	72.78	29.50
2X6	STANDARD	STANDARD	72.79	35.58
2X8	STANDARD	STANDARD	72.67	42.25
2X10	STANDARD	STANDARD	72.78	49.05

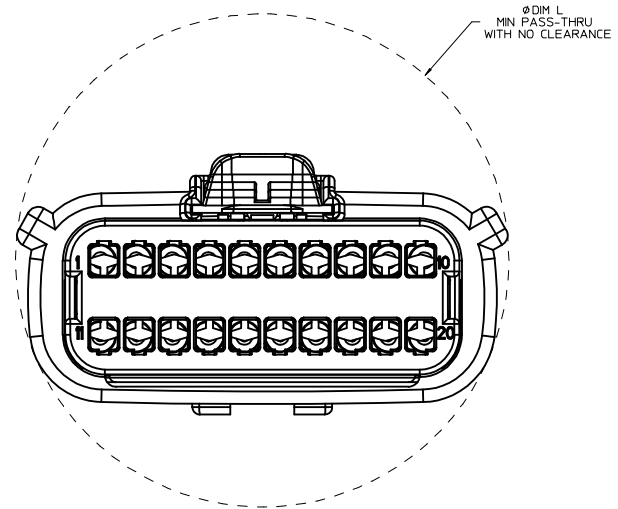
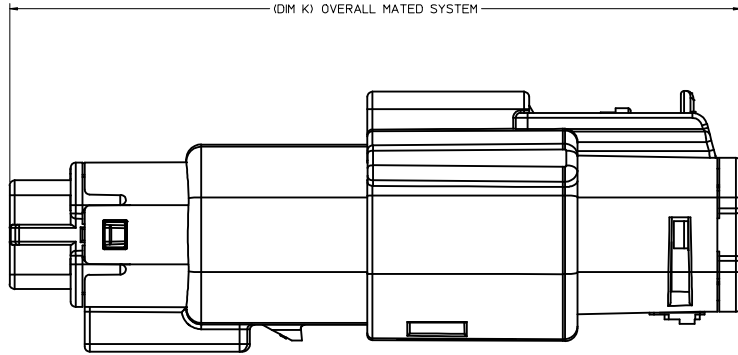

ENTER DESCRIPTION EC NO: UA02016-1539 D DRAINABTANG 2016/05/16 CHKD: APPR:KDEKOSKI 2016/05/24	QUALITY SYMBOLS	GENERAL TOLERANCES (UNLESS SPECIFIED)	DIMENSION STYLE	SCALE	DESIGN UNITS	THIRD ANGLE PROJECTION
	▽=0	mm INCH	MM ONLY	4:1	METRIC	
	▽=0	4 PLACES ± --- ± ---	DRAWN BY DATE	TITLE		
	▽=0	3 PLACES ± --- ± ---	APPROFFITT 2014/04/28	MX150 BLADE DUAL ROW SEALED ASSEMBLY MAT SEAL		
▽=0	2 PLACES ± 0.10 ± ---	CHECKED BY DATE	molex			
	1 PLACE ± 0.2 ± ---	KBORUSZEWSKI 2014/04/29	DOCUMENT NO. SD-33482-0001			
	0 PLACE ± --- ± ---	APPROVED BY DATE	SHEET NO. 6 OF 9			
	ANGULAR ± 1 °	VKOSHY 2014/05/14	SEE NOTE 2a.			
	DRAFT WHERE APPLICABLE MUST REMAIN WITHIN DIMENSIONS	MATERIAL NO.	THIS DRAWING CONTAINS INFORMATION THAT IS PROPRIETARY TO MOLEX INCORPORATED AND SHOULD NOT BE USED WITHOUT WRITTEN PERMISSION			

SHEET DESCRIPTION
BACKSHELL NOTES

BACKSHELL NOTES: VALID UNLESS OTHERWISE SPECIFIED

1. GENERAL:
 a. APPLICATION SPECIFICATION SEE: AS-34951-001
 -DESIGNED TO MATE WITH BLADE SEALED ASSEMBLY SPECIFIED IN MOLEX DRAWING SD-33482-0001.
 -SYSTEM TO BE USED WITH WIRE WITHIN DIAMETER RANGE OF 1.2mm TO 2.69mm.
 -COMPONENTS ARE OPTIONAL AND MUST BE PURCHASED SEPERATELY.
 -BACKSHELL DESIGN IS OWNED BY SCHLEMMER.
 -FOR ADDITIONAL INFORMATION SEE THE BACKSHELL COMPONENT DRAWING SD-34950-0001.

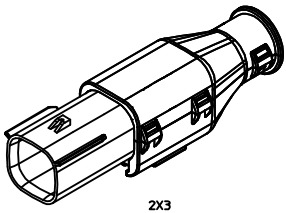

2X3

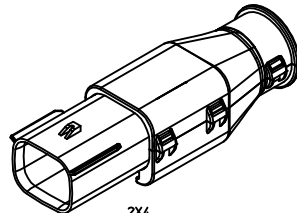

2X4

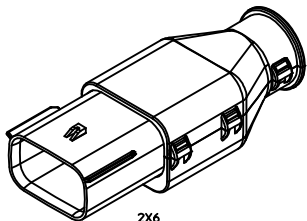

2X6

BACKSHELL CUSTOMER MODEL NUMBER LEGEND

- 34950-XXXX
- CUSTOMER MODEL COMPONENTS
 - 0 - BACKSHELL ONLY
 - 1 - BACKSHELL & MX150 HOUSING KEY A ASSEMBLY
 - 2 - BACKSHELL & MX150 HOUSING KEY B ASSEMBLY
 - 3 - BACKSHELL & MX150 HOUSING KEY C ASSEMBLY
 - 4 - BACKSHELL & MX150 HOUSING KEY D ASSEMBLY
 - BACKSHELL FEATURES
 - 1 - WITH RIBS
 - 2 - WITHOUT RIBS
 - MX150 CIRCUIT SIZE 04, 06, 08, 12, 16, 20

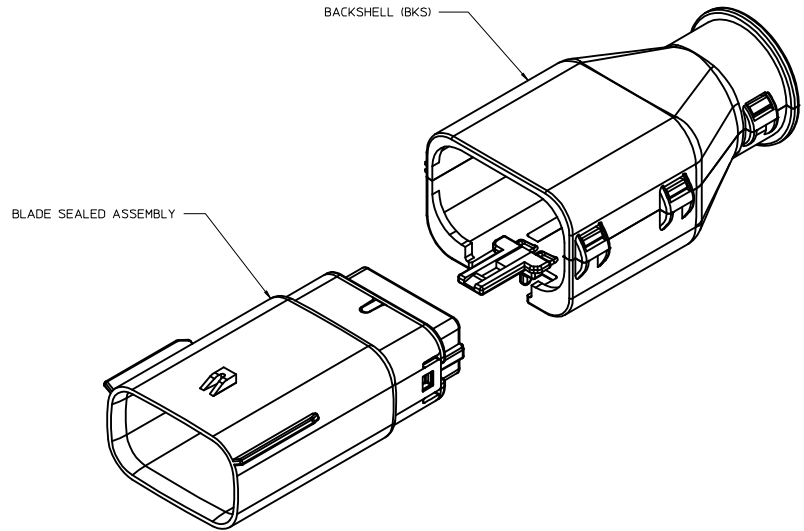

ENTER DESCRIPTION EC NO: UAU2016-1539 DRAWN BY: DRW:RBTANG 2016/05/16 CHKD: APPR:KOEKOSKI 2016/05/24 D REV	QUALITY SYMBOLS	GENERAL TOLERANCES (UNLESS SPECIFIED)	DIMENSION STYLE	SCALE	DESIGN UNITS	THIRD ANGLE PROJECTION
		mm INCH	MM ONLY	4:1	METRIC	
	▽=0	4 PLACES ± --- ± ---	DRAWN BY DATE	TITLE		
	▽=0	3 PLACES ± --- ± ---	APPROFIT 2014/04/28	MX150 BLADE DUAL ROW SEALED ASSEMBLY MAT SEAL		
▽=0	2 PLACES ± 0.10 ± ---	CHECKED BY DATE	molex DOCUMENT NO. SD-33482-0001 SHEET NO. 7 OF 9			
▽=0	1 PLACE ± 0.2 ± ---	KBORUSZEWSKI 2014/04/29				
▽=0	0 PLACE ± --- ± ---	APPROVED BY DATE				
	ANGULAR ± 1 °	VKOSHY 2014/05/14				
	DRAFT WHERE APPLICABLE MUST REMAIN WITHIN DIMENSIONS	MATERIAL NO.	SEE NOTE 2a.			
		SIZE	THIS DRAWING CONTAINS INFORMATION THAT IS PROPRIETARY TO MOLEX INCORPORATED AND SHOULD NOT BE USED WITHOUT WRITTEN PERMISSION			

SHEET DESCRIPTION

BACKSHELL

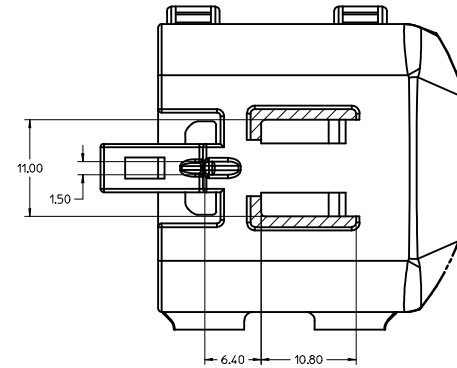
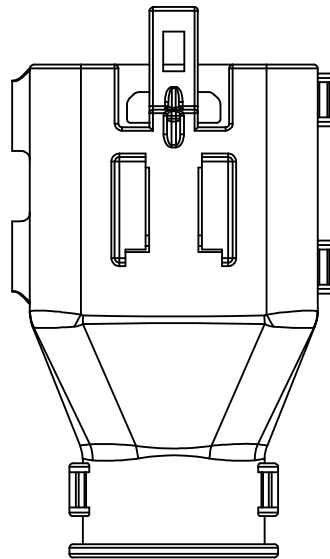
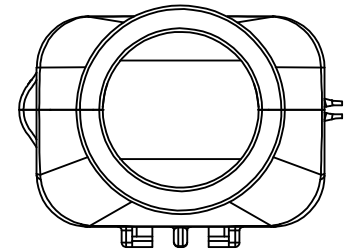
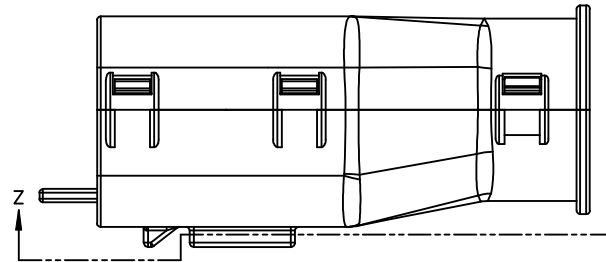
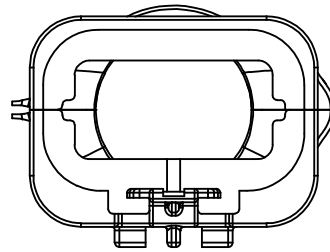
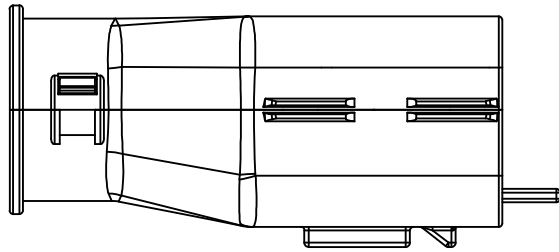

Partial Z-Z
SCALE 35:1

ENTER DESCRIPTION EC NO: UA02016-1539 D DRAINABTANG 2016/05/16 CHKD: APPR:KDEKOSKI 2016/05/24	QUALITY SYMBOLS ∇=0 ∇=0 ∇=0	GENERAL TOLERANCES (UNLESS SPECIFIED) mm INCH 4 PLACES ± --- ± --- 3 PLACES ± --- ± --- 2 PLACES ± 0.10 ± --- 1 PLACE ± 0.2 ± --- 0 PLACE ± --- ± ---	DIMENSION STYLE MM ONLY	SCALE 3.5:1	DESIGN UNITS METRIC	THIRD ANGLE PROJECTION	
	DRAWN BY DATE APPROFFITT 2014/04/28	CHECKED BY DATE KBORUSZEWSKI 2014/04/29	APPROVED BY DATE VKOSHY 2014/05/14	MATERIAL NO. SEE NOTE 2a.	DOCUMENT NO. SD-33482-0001	SHEET NO. 8 OF 9	THIS DRAWING CONTAINS INFORMATION THAT IS PROPRIETARY TO MOLEX INCORPORATED AND SHOULD NOT BE USED WITHOUT WRITTEN PERMISSION
	ANGULAR ± 1 ° DRAFT WHERE APPLICABLE MUST REMAIN WITHIN DIMENSIONS	SEE NOTE 2a.					
	THIS DRAWING CONTAINS INFORMATION THAT IS PROPRIETARY TO MOLEX INCORPORATED AND SHOULD NOT BE USED WITHOUT WRITTEN PERMISSION						

MX150 BLADE
DUAL ROW SEALED ASSEMBLY
MAT SEAL



SHEET DESCRIPTION
BACKSHELL CONFIGURATIONS

CHARTED DIMENSIONS							
CKT	BLADE CONFIGURATION	RECEPTACLE CONFIGURATION	DIMENSIONS				
			M	N	P	R	S
2X3	STANDARD	STANDARD	106.83	32.75	31.75	29.00	29.50
	LENGTHENED	STANDARD	108.71				
2X4	STANDARD	STANDARD	106.83	33.50	31.90	30.70	30.70
2X6	STANDARD	STANDARD	106.83	37.84	37.27	35.83	36.83

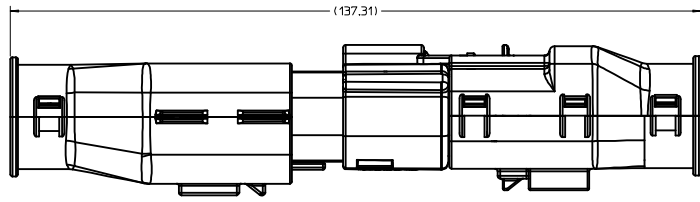

OVERALL MATED SYSTEM WITH BLADE AND RECEPTACLE BACKSHELL

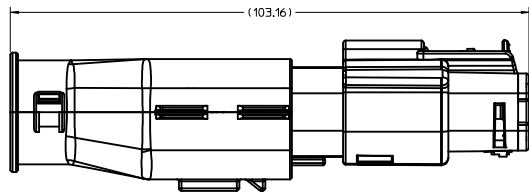
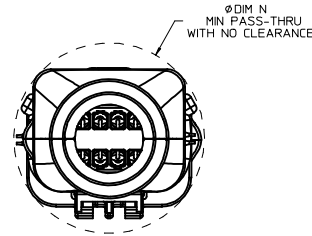

OVERALL MATED SYSTEM WITH BLADE BACKSHELL

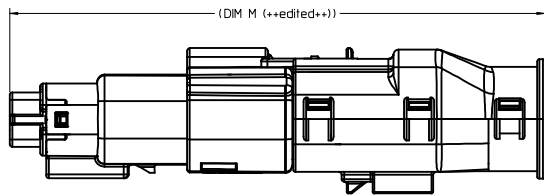
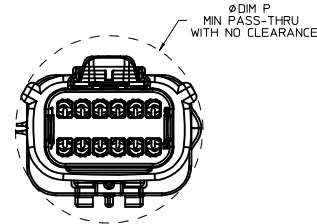

OVERALL MATED SYSTEM WITH RECEPTACLE BACKSHELL

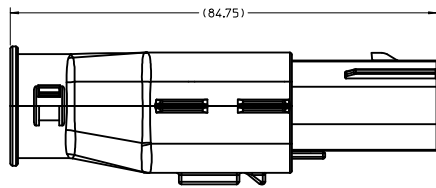
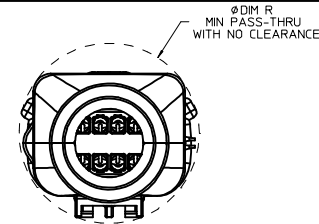

BLADE SEALED ASSEMBLY WITH BLADE BACKSHELL

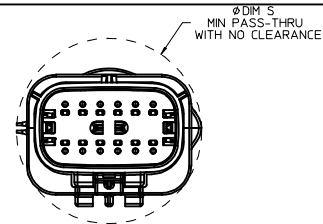

ENTER DESCRIPTION EC NO: UAU2016-1539 D: DRWN:BTANG 2016/05/16 CHKD: APPR:KDKOSKI 2016/05/24	QUALITY SYMBOLS ∇=0 ∇=0 ∇=0	GENERAL TOLERANCES (UNLESS SPECIFIED) mm INCH 4 PLACES ± --- ± --- 3 PLACES ± --- ± --- 2 PLACES ± 0.10 ± --- 1 PLACE ± 0.2 ± --- 0 PLACE ± --- ± --- ANGULAR ± 1 ° DRAFT WHERE APPLICABLE MUST REMAIN WITHIN DIMENSIONS	DIMENSION STYLE MM ONLY	SCALE 2:1	DESIGN UNITS METRIC	THIRD ANGLE PROJECTION	
	DRAWN BY APPROFFITT	DATE 2014/04/28	CHECKED BY KBORUSZEWSKI	DATE 2014/04/29	APPROVED BY VKOSHY	DATE 2014/05/14	TITLE MX150 BLADE DUAL ROW SEALED ASSEMBLY MAT SEAL molex
	MATERIAL NO. SEE NOTE 2a.	DOCUMENT NO. SD-33482-0001	SHEET NO. 9 OF 9	THIS DRAWING CONTAINS INFORMATION THAT IS PROPRIETARY TO MOLEX INCORPORATED AND SHOULD NOT BE USED WITHOUT WRITTEN PERMISSION			
	SIZE 1						

MX150 2X2 BLADE SEALED ASSEMBLY MAT SEAL
BOM AND PIN OUT SHEET

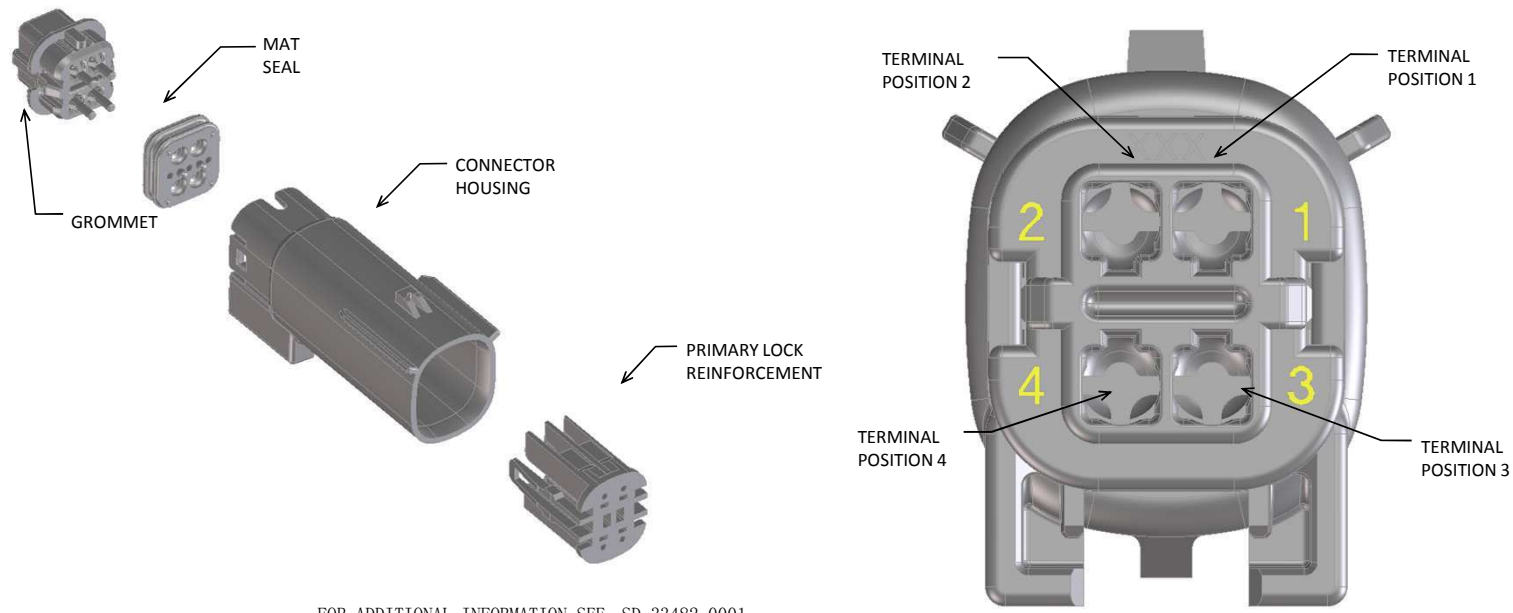

ABBREVIATION	DESCRIPTION	COLOR	MATERIAL
A-BLK	HOUSING, KEYING OPTION A	BLACK	SPS/NYLON GF20
B-LG	HOUSING, KEYING OPTION B	LIGHT GRAY	SPS/NYLON GF20
C-BR	HOUSING, KEYING OPTION C	BROWN	SPS/NYLON GF20
D-GR	HOUSING, KEYING OPTION D	GREEN	SPS/NYLON GF20
C-DG	HOUSING, KEYING OPTION C	DARK GRAY	SPS/NYLON GF20
D-SG	HOUSING, KEYING OPTION D	STONE GRAY	SPS/NYLON GF20
A-YW	HOUSING, KEYING OPTION A	YELLOW	SPS/NYLON GF20
GCP	GROMMET CAP (PLUGGED)	BLACK	SPS/NYLON GF20
GCO	GROMMET CAP (OPEN)	BLACK	SPS/NYLON GF20
PLR	PLR	NATURAL	SPS/NYLON GF20
M	MAT SEAL	ROYAL BLUE	INHERENTLY LUBRICATED SILICONE

FOR ADDITIONAL INFORMATION SEE SD-33482-0001

ASSEMBLY DESCRIPTION	ASSEMBLY PART NUMBER	COMPONENT				BLOCKED TERMINALS											STATUS	COMMENTS	OPTIONAL ATTACHMENTS SOLD SEPERATELY			
		THE PRESENCE OF AN ABBREVIATION INDICATES THE PRESENCE OF THAT COMPONENT.				CAVITY WITH A NUMBER INDICATES BLOCKED TERMINAL POSITION CAVITY WITHOUT A NUMBER INDICATES OPEN TERMINAL POSITION													BACKSHELL WITH RIBS	BACKSHELL WITHOUT RIBS		
		HOUSING KEY/COLOR	GROMMET CAP	PLR	MAT SEAL	1	2	3	4													
KEY A, BLACK	33482-4001	A-BLK	GCO	PLR	M															SALEABLE		
KEY B, LIGHT GRAY	33482-4002	B-LG	GCO	PLR	M															SALEABLE		
KEY C, BROWN	33482-4003	C-BR	GCO	PLR	M															NOT RECOMMENDED	SEE 33482-4103	
KEY D, GREEN	33482-4004	D-GR	GCO	PLR	M															NOT RECOMMENDED	SEE 33482-4104	
KEY A, BLACK	33482-4006	A-BLK	GCP	PLR	M		2													SALEABLE		
KEY B, LIGHT GRAY	33482-4007	B-LG	GCP	PLR	M		2													SALEABLE		
KEY C, BROWN	33482-4008	C-BR	GCP	PLR	M		2													NOT RECOMMENDED	SEE 33482-4105	
KEY D, GREEN	33482-4009	D-GR	GCP	PLR	M		2													NOT RECOMMENDED	SEE 33482-4106	
KEY A, BLACK	33482-4011	A-BLK	GCP	PLR	M		2	3												SALEABLE		
KEY B, LIGHT GRAY	33482-4012	B-LG	GCP	PLR	M		2	3												SALEABLE		
KEY C, BROWN	33482-4013	C-BR	GCP	PLR	M		2	3												NOT RECOMMENDED	SEE 33482-4107	
KEY D, GREEN	33482-4014	D-GR	GCP	PLR	M		2	3												NOT RECOMMENDED	SEE 33482-4108	
KEY A, BLACK	33482-4016	A-BLK	GCP	PLR	M	1	2	3	4											SALEABLE		
KEY B, LIGHT GRAY	33482-4017	B-LG	GCP	PLR	M	1	2	3	4											SALEABLE		
KEY C, BROWN	33482-4018	C-BR	GCP	PLR	M	1	2	3	4											NOT RECOMMENDED	SEE 33482-4109	
KEY D, GREEN	33482-4019	D-GR	GCP	PLR	M	1	2	3	4											NOT RECOMMENDED	SEE 33482-4110	
KEY A, BLACK	33482-4021	A-BLK	GCP	PLR	M	1	2	3												SALEABLE		
KEY A, BLACK	33482-4022	A-BLK	GCP	PLR	M				4											SALEABLE		
KEY A, BLACK	33482-4023	A-BLK	GCP	PLR	M			3	4											SALEABLE		
KEY A, BLACK	33482-4024	A-BLK	GCP	PLR	M			3												SALEABLE		
KEY A, BLACK	33482-4025	A-BLK	GCP	PLR	M	1	2													SALEABLE		
KEY C, DARK GRAY	33482-4103	C-DG	GCO	PLR	M															SALEABLE		
KEY D, STONE GRAY	33482-4104	D-SG	GCO	PLR	M															SALEABLE		
KEY C, DARK GRAY	33482-4105	C-DG	GCP	PLR	M		2													SALEABLE		
KEY D, STONE GRAY	33482-4106	D-SG	GCP	PLR	M		2													SALEABLE		
KEY C, DARK GRAY	33482-4107	C-DG	GCP	PLR	M		2	3												SALEABLE		
KEY D, STONE GRAY	33482-4108	D-SG	GCP	PLR	M		2	3												SALEABLE		
KEY C, DARK GRAY	33482-4109	C-DG	GCP	PLR	M	1	2	3	4											SALEABLE		
KEY D, STONE GRAY	33482-4110	D-SG	GCP	PLR	M	1	2	3	4											SALEABLE		
KEY A, BLACK	33482-4111	A-BLK	GCP	PLR	M		2		4											SALEABLE		
KEY A, YELLOW	33482-4112	A-YW	GCO	PLR	M															SALEABLE		
KEY B, LIGHT GRAY	33482-4113	B-LG	GCP	PLR	M	1														SALEABLE		
KEY A, BLACK	33482-4115	A-BLK	GCP	PLR	M	1		3												SALEABLE		
KEY C, DARK GRAY	33482-4116	C-DG	GCP	PLR	M		2		4											SALEABLE		
KEY B, LIGHT GRAY	33482-4117	B-LG	GCP	PLR	M		2		4											SALEABLE		

**MX150 2X3 BLADE SEALED ASSEMBLY MAT SEAL
BOM AND PIN OUT SHEET**

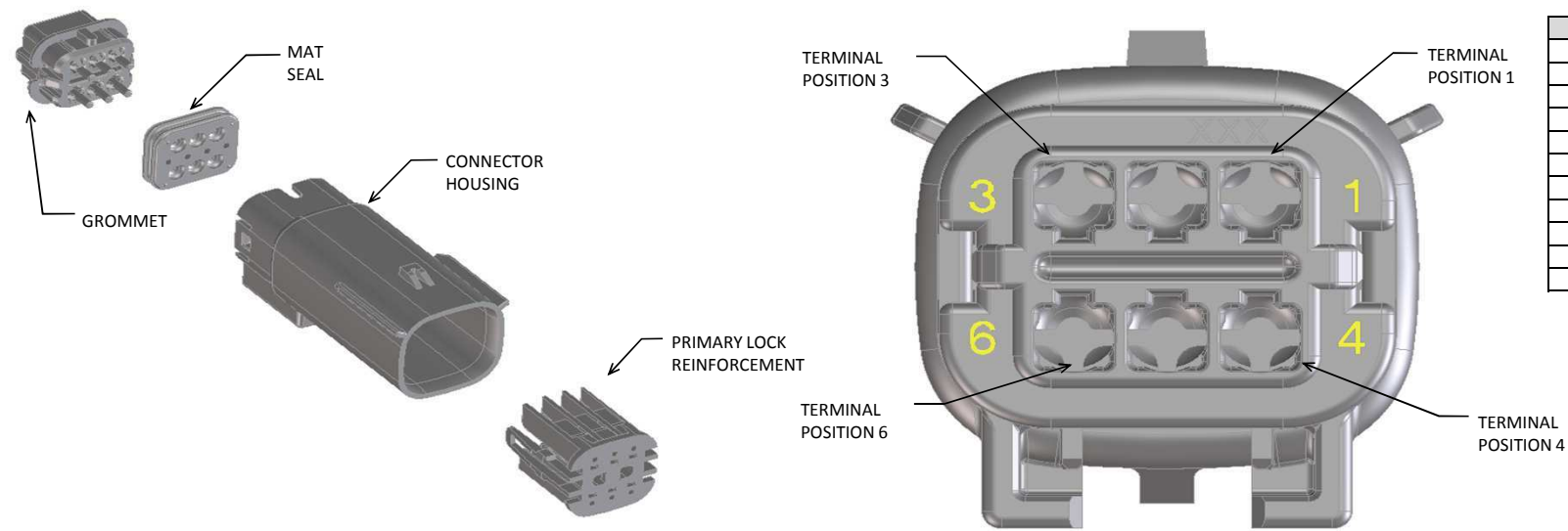

ABBREVIATION	DESCRIPTION	COLOR	MATERIAL
A-BLK	HOUSING, KEYING OPTION A	BLACK	SPS/NYLON GF20
B-LG	HOUSING, KEYING OPTION B	LIGHT GRAY	SPS/NYLON GF20
C-BR	HOUSING, KEYING OPTION C	BROWN	SPS/NYLON GF20
D-GR	HOUSING, KEYING OPTION D	GREEN	SPS/NYLON GF20
C-DG	HOUSING, KEYING OPTION C	DARK GRAY	SPS/NYLON GF20
D-SG	HOUSING, KEYING OPTION D	STONE GRAY	SPS/NYLON GF20
A-YW	HOUSING, KEYING OPTION A	YELLOW	SPS/NYLON GF20
GC	GROMMET CAP (STANDARD)	BLACK	SPS/NYLON GF20
GCL	GROMMET CAP (LENGTHENED)	BLACK	SPS/NYLON GF20
PLR	PLR	NATURAL	SPS/NYLON GF20
M	MAT SEAL	ROYAL BLUE	INHERENTLY LUBRICATED SILICONE

FOR ADDITIONAL INFORMATION SEE SD-33482-0001

ASSEMBLY DESCRIPTION	ASSEMBLY PART NUMBER	COMPONENT				BLOCKED TERMINALS												STATUS	COMMENTS	OPTIONAL ATTACHMENTS SOLD SEPERATELY			
		THE PRESENCE OF AN ABBREVIATION INDICATES THE PRESENCE OF THAT COMPONENT.				CAVITY WITH A NUMBER INDICATES BLOCKED TERMINAL POSITION CAVITY WITHOUT A NUMBER INDICATES OPEN TERMINAL POSITION														BACKSHELL WITH RIBS	BACKSHELL WITHOUT RIBS		
		HOUSING KEY/COLOR	GROMMET CAP	PLR	MAT SEAL	1	2	3	4	5	6												
KEY A, BLACK	33482-3601	A-BLK	GC	PLR	M															SALEABLE		34950-0610	34950-0620
KEY B, LIGHT GRAY	33482-3602	B-LG	GC	PLR	M															SALEABLE		34950-0610	34950-0620
KEY C, BROWN	33482-3603	C-BR	GC	PLR	M															NOT RECOMMENDED	SEE 33482-3628	34950-0610	34950-0620
KEY D, GREEN	33482-3604	D-GR	GC	PLR	M															NOT RECOMMENDED	SEE 33482-3629	34950-0610	34950-0620
VOID KEY	33482-3605																						
KEY A, BLACK	33482-3606	A-BLK	GC	PLR	M					3										SALEABLE		34950-0610	34950-0620
KEY B, LIGHT GRAY	33482-3607	B-LG	GC	PLR	M					3										SALEABLE		34950-0610	34950-0620
KEY C, BROWN	33482-3608	C-BR	GC	PLR	M					3										NOT RECOMMENDED	SEE 33482-3638	34950-0610	34950-0620
KEY D, GREEN	33482-3609	D-GR	GC	PLR	M					3										NOT RECOMMENDED	SEE 33482-3641	34950-0610	34950-0620
VOID KEY	33482-3610																						
KEY A, BLACK	33482-3611	A-BLK	GC	PLR	M					3	4									SALEABLE		34950-0610	34950-0620
KEY B, LIGHT GRAY	33482-3612	B-LG	GC	PLR	M					3	4									SALEABLE		34950-0610	34950-0620
KEY C, BROWN	33482-3613	C-BR	GC	PLR	M					3	4									NOT RECOMMENDED	SEE 33482-3642	34950-0610	34950-0620
KEY D, GREEN	33482-3614	D-GR	GC	PLR	M					3	4									NOT RECOMMENDED	SEE 33482-3643	34950-0610	34950-0620
VOID KEY	33482-3615																						
KEY A, BLACK	33482-3616	A-BLK	GC	PLR	M					3										SALEABLE		34950-0610	34950-0620
KEY A, BLACK	33482-3617	A-BLK	GC	PLR	M						2									SALEABLE		34950-0610	34950-0620
KEY A, BLACK	33482-3618	A-BLK	GC	PLR	M									5	6					SALEABLE		34950-0610	34950-0620
KEY A, BLACK	33482-3619	A-BLK	GC	PLR	M						2	3	4	5						SALEABLE		34950-0610	34950-0620
KEY A, BLACK	33482-3620	A-BLK	GC	PLR	M						1	2	3	4	5	6				SALEABLE		34950-0610	34950-0620
KEY A, BLACK	33482-3621	A-BLK	GC	PLR	M						1			4	5					SALEABLE		34950-0610	34950-0620
KEY A, BLACK	33482-3622	A-BLK	GC	PLR	M									4	5	6				SALEABLE		34950-0610	34950-0620
KEY A, BLACK	33482-3623	A-BLK	GC	PLR	M										5					SALEABLE		34950-0610	34950-0620
KEY A, BLACK	33482-3624	A-BLK	GC	PLR	M											6				SALEABLE		34950-0610	34950-0620
KEY B, LIGHT GRAY	33482-3625	B-LG	GC	PLR	M						1				5					SALEABLE		34950-0610	34950-0620
KEY A, BLACK	33482-3626	A-BLK	GC	PLR	M						1	2	3	4						SALEABLE		34950-0610	34950-0620
KEY A, BLACK	33482-3627	A-BLK	GC	PLR	M							2	3		5	6				SALEABLE		34950-0610	34950-0620
KEY C, DARK GRAY	33482-3628	C-DG	GC	PLR	M															SALEABLE		34950-0610	34950-0620
KEY D, STONE GRAY	33482-3629	D-SG	GC	PLR	M															SALEABLE		34950-0610	34950-0620
KEY A, BLACK	33482-3630	A-BLK	GC	PLR	M							3				6				SALEABLE		34950-0610	34950-0620
KEY A, BLACK	33482-3631	A-BLK	GCL	PLR	M															SALEABLE		34950-0610	34950-0620
KEY B, LIGHT GRAY	33482-3632	B-LG	GCL	PLR	M															SALEABLE		34950-0610	34950-0620
KEY C, DARK GRAY	33482-3633	C-DG	GCL	PLR	M															SALEABLE		34950-0610	34950-0620
KEY D, STONE GRAY	33482-3634	D-SG	GCL	PLR	M															SALEABLE		34950-0610	34950-0620
KEY C, DARK GRAY	33482-3635	C-DG	GCL	PLR	M															SALEABLE		34950-0610	34950-0620
KEY A, BLACK	33482-3636	A-BLK	GCL	PLR	M															SALEABLE		34950-0610	34950-0620
KEY A, BLACK	33482-3637	A-BLK	GC	PLR	M							2				6				SALEABLE		34950-0610	34950-0620
KEY C, DARK GRAY	33482-3638	C-DG	GC	PLR	M															SALEABLE		34950-0610	34950-0620
KEY A, BLACK	33482-3639	A-BLK	GCL	PLR	M						1	2	3	4	5	6				SALEABLE		34950-0610	34950-0620
KEY A, BLACK	33482-3640	A-BLK	GC	PLR	M															SALEABLE		34950-0610	34950-0620
KEY D, STONE GRAY	33482-3641	D-SG	GC	PLR	M															SALEABLE		34950-0610	34950-0620
KEY C, DARK GRAY	33482-3642	C-DG	GC	PLR	M															SALEABLE		34950-0610	34950-0620
KEY D, STONE GRAY	33482-3643	D-SG	GC	PLR	M															SALEABLE		34950-0610	34950-0620
KEY A, YELLOW	33482-3644	A-YW	GC	PLR	M															SALEABLE		34950-0610	34950-0620
KEY A, BLACK	33482-3645	A-BLK	GC	PLR	M															SALEABLE		34950-0610	34950-0620
KEY A, BLACK	33482-3646	A-BLK	GC	PLR	M							2	3							SALEABLE		34950-0610	34950-0620
KEY B, LIGHT GRAY	33482-3647	B-LG	GC	PLR	M							2	3							SALEABLE		34950-0610	34950-0620
KEY C, DARK GRAY	33482-3648	C-DG	GC	PLR	M															SALEABLE		34950-0610	34950-0620
KEY A, BLACK	33482-3649	A-BLK	GC	PLR	M															SALEABLE		34950-0610	34950-0620

**MX150 2X3 BLADE SEALED ASSEMBLY MAT SEAL
BOM AND PIN OUT SHEET**

ASSEMBLY DESCRIPTION	ASSEMBLY PART NUMBER	COMPONENT				BLOCKED TERMINALS										STATUS	COMMENTS	OPTIONAL ATTACHMENTS SOLD SEPERATELY		
		THE PRESENCE OF AN ABBREVIATION INDICATES THE PRESENCE OF THAT COMPONENT.				CAVITY WITH A NUMBER INDICATES BLOCKED TERMINAL POSITION CAVITY WITHOUT A NUMBER INDICATES OPEN TERMINAL POSITION												BACKSHELL WITH RIBS	BACKSHELL WITHOUT RIBS	
		HOUSING KEY/COLOR	GROMMET CAP	PLR	MAT SEAL	1	2	3	4	5	6									
KEY A, BLACK	33482-3650	A-BLK	GC	PLR	M	1		3		5							SALEABLE		34950-0610	34950-0620
KEY A, BLACK	33482-3651	A-BLK	GC	PLR	M		2		4		6						SALEABLE		34950-0610	34950-0620
KEY A, BLACK	33482-3652	A-BLK	GC	PLR	M	1					6						SALEABLE		34950-0610	34950-0620

MX150 2X4 BLADE SEALED ASSEMBLY MAT SEAL
BOM AND PIN OUT SHEET

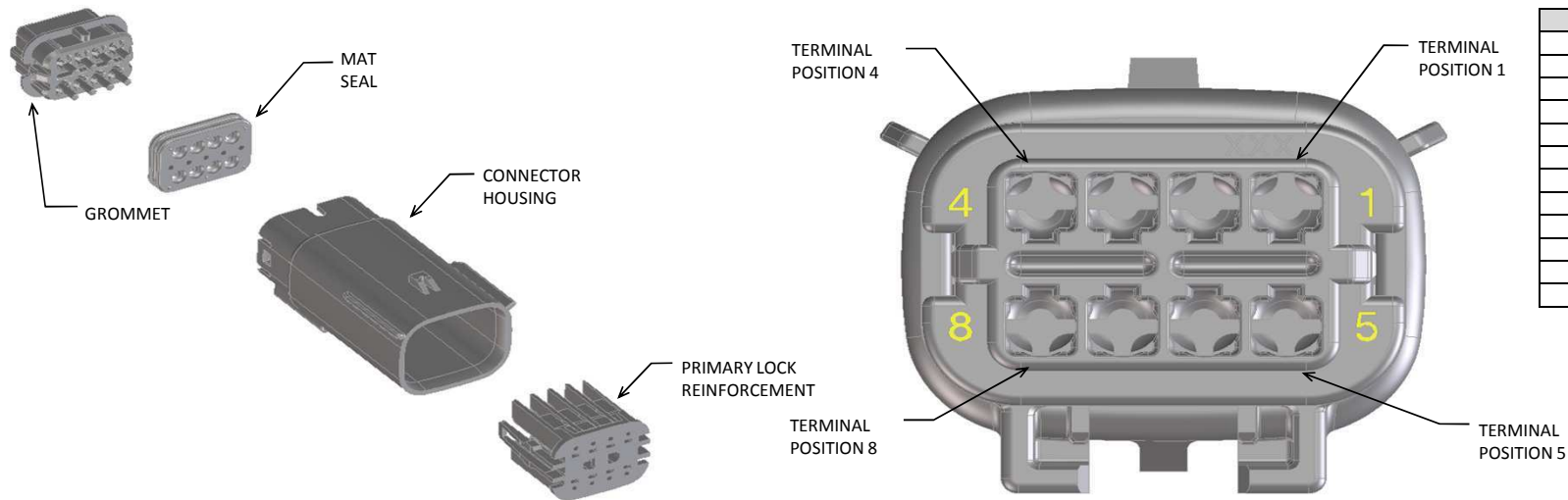

ABBREVIATION	DESCRIPTION	COLOR	MATERIAL
A-BLK	HOUSING, KEYING OPTION A	BLACK	SPS/NYLON GF20
B-LG	HOUSING, KEYING OPTION B	LIGHT GRAY	SPS/NYLON GF20
C-BR	HOUSING, KEYING OPTION C	BROWN	SPS/NYLON GF20
D-GR	HOUSING, KEYING OPTION D	GREEN	SPS/NYLON GF20
C-DG	HOUSING, KEYING OPTION C	DARK GRAY	SPS/NYLON GF20
D-SG	HOUSING, KEYING OPTION D	STONE GRAY	SPS/NYLON GF20
A-YW	HOUSING, KEYING OPTION A	YELLOW	SPS/NYLON GF20
GCP	GROMMET CAP (PLUGGED)	BLACK	SPS/NYLON GF20
GCO	GROMMET CAP (OPEN)	BLACK	SPS/NYLON GF20
PLR	PLR	NATURAL	SPS/NYLON GF20
M-R	MAT SEAL	RUST RED	INHERENTLY LUBRICATED SILICONE
M-B	MAT SEAL	ROYAL BLUE	INHERENTLY LUBRICATED SILICONE

FOR ADDITIONAL INFORMATION SEE SD-33482-0001

ASSEMBLY DESCRIPTION	ASSEMBLY PART NUMBER	COMPONENT				BLOCKED TERMINALS								STATUS	COMMENTS	OPTIONAL ATTACHMENTS SOLD SEPERATELY				
		THE PRESENCE OF AN ABBREVIATION INDICATES THE PRESENCE OF THAT COMPONENT.				CAVITY WITH A NUMBER INDICATES BLOCKED TERMINAL POSITION CAVITY WITHOUT A NUMBER INDICATES OPEN TERMINAL POSITION										BACKSHELL WITH RIBS	BACKSHELL WITHOUT RIBS			
		HOUSING KEY/COLOR	GROMMET CAP	PLR	MAT SEAL	1	2	3	4	5	6	7	8							
KEY A, BLACK	33482-0801	A-BLK	GCO	PLR	M-R											PLANNED OBSOLESCENCE	SEE 33482-4801	34950-0810	34950-0820	
KEY B, LIGHT GRAY	33482-0802	B-LG	GCO	PLR	M-R												PLANNED OBSOLESCENCE	SEE 33482-4802	34950-0810	34950-0820
KEY C, BROWN	33482-0803	C-BR	GCO	PLR	M-R												PLANNED OBSOLESCENCE	SEE 33482-4803	34950-0810	34950-0820
KEY D, GREEN	33482-0804	D-GR	GCO	PLR	M-R												PLANNED OBSOLESCENCE	SEE 33482-4804	34950-0810	34950-0820
VOID KEY	33482-0805																			
KEY A, BLACK	33482-0806	A-BLK	GCP	PLR	M-R				4								PLANNED OBSOLESCENCE	SEE 33482-4806	34950-0810	34950-0820
KEY B, LIGHT GRAY	33482-0807	B-LG	GCP	PLR	M-R				4								PLANNED OBSOLESCENCE	SEE 33482-4807	34950-0810	34950-0820
KEY C, BROWN	33482-0808	C-BR	GCP	PLR	M-R				4								PLANNED OBSOLESCENCE	SEE 33482-4808	34950-0810	34950-0820
KEY D, GREEN	33482-0809	D-GR	GCP	PLR	M-R				4								PLANNED OBSOLESCENCE	SEE 33482-4809	34950-0810	34950-0820
VOID KEY	33482-0810																			
KEY A, BLACK	33482-0811	A-BLK	GCP	PLR	M-R				4	5							PLANNED OBSOLESCENCE	SEE 33482-4811	34950-0810	34950-0820
KEY B, LIGHT GRAY	33482-0812	B-LG	GCP	PLR	M-R				4	5							PLANNED OBSOLESCENCE	SEE 33482-4812	34950-0810	34950-0820
KEY C, BROWN	33482-0813	C-BR	GCP	PLR	M-R				4	5							PLANNED OBSOLESCENCE	SEE 33482-4813	34950-0810	34950-0820
KEY D, GREEN	33482-0814	D-GR	GCP	PLR	M-R				4	5							PLANNED OBSOLESCENCE	SEE 33482-4814	34950-0810	34950-0820
VOID KEY	33482-0815																			
KEY A, BLACK	33482-0816	A-BLK	GCP	PLR	M-R	1			4	5							PLANNED OBSOLESCENCE	SEE 33482-4816	34950-0810	34950-0820
KEY B, LIGHT GRAY	33482-0817	B-LG	GCP	PLR	M-R	1			4	5							PLANNED OBSOLESCENCE	SEE 33482-4817	34950-0810	34950-0820
KEY C, BROWN	33482-0818	C-BR	GCP	PLR	M-R	1			4	5							PLANNED OBSOLESCENCE	SEE 33482-4818	34950-0810	34950-0820
KEY D, GREEN	33482-0819	D-GR	GCP	PLR	M-R	1			4	5							PLANNED OBSOLESCENCE	SEE 33482-4819	34950-0810	34950-0820
VOID KEY	33482-0820																			
KEY A, BLACK	33482-0821	A-BLK	GCP	PLR	M-R	1			4	5				8			PLANNED OBSOLESCENCE	SEE 33482-4821	34950-0810	34950-0820
KEY B, LIGHT GRAY	33482-0822	B-LG	GCP	PLR	M-R	1			4	5				8			PLANNED OBSOLESCENCE	SEE 33482-4822	34950-0810	34950-0820
KEY C, BROWN	33482-0823	C-BR	GCP	PLR	M-R	1			4	5				8			PLANNED OBSOLESCENCE	SEE 33482-4823	34950-0810	34950-0820
KEY D, GREEN	33482-0824	D-GR	GCP	PLR	M-R	1			4	5				8			PLANNED OBSOLESCENCE	SEE 33482-4824	34950-0810	34950-0820
VOID KEY	33482-0825																			
KEY A, BLACK	33482-0826	A-BLK	GCP	PLR	M-R	1	2	3				6	7	8			PLANNED OBSOLESCENCE	SEE 33482-4826	34950-0810	34950-0820
KEY A, BLACK	33482-0827	A-BLK	GCP	PLR	M-R									8			PLANNED OBSOLESCENCE	SEE 33482-4827	34950-0810	34950-0820
KEY A, BLACK	33482-0828	A-BLK	GCP	PLR	M-R			3		5							PLANNED OBSOLESCENCE	SEE 33482-4828	34950-0810	34950-0820
KEY A, BLACK	33482-0829	A-BLK	GCP	PLR	M-R		2	3	4	5	6	7					PLANNED OBSOLESCENCE	SEE 33482-4829	34950-0810	34950-0820
KEY A, BLACK	33482-0830	A-BLK	GCP	PLR	M-R						6						PLANNED OBSOLESCENCE	SEE 33482-4830	34950-0810	34950-0820
KEY A, BLACK	33482-0831	A-BLK	GCP	PLR	M-R				3		5	6					PLANNED OBSOLESCENCE	SEE 33482-4831	34950-0810	34950-0820
KEY A, BLACK	33482-0832	A-BLK	GCP	PLR	M-R					5	6		8				PLANNED OBSOLESCENCE	SEE 33482-4832	34950-0810	34950-0820
KEY A, BLACK	33482-0833	A-BLK	GCP	PLR	M-R	1		3		5							PLANNED OBSOLESCENCE	SEE 33482-4833	34950-0810	34950-0820
KEY A, BLACK	33482-0834	A-BLK	GCP	PLR	M-R	1	2	3	4	5	6	7	8				PLANNED OBSOLESCENCE	SEE 33482-4834	34950-0810	34950-0820
KEY A, BLACK	33482-0835	A-BLK	GCP	PLR	M-R							7	8				PLANNED OBSOLESCENCE	SEE 33482-4835	34950-0810	34950-0820
KEY A, BLACK	33482-0836	A-BLK	GCP	PLR	M-R		2	3			6	7	8				PLANNED OBSOLESCENCE	SEE 33482-4836	34950-0810	34950-0820
KEY A, BLACK	33482-0837	A-BLK	GCP	PLR	M-R	1			4								PLANNED OBSOLESCENCE	SEE 33482-4837	34950-0810	34950-0820
KEY A, BLACK	33482-0838	A-BLK	GCP	PLR	M-R		2	3		5	6	7	8				PLANNED OBSOLESCENCE	SEE 33482-4838	34950-0810	34950-0820
KEY B, LIGHT GRAY	33482-0839	B-LG	GCP	PLR	M-R								8				PLANNED OBSOLESCENCE	SEE 33482-4839	34950-0810	34950-0820
KEY A, BLACK	33482-0840	A-BLK	GCP	PLR	M-R		2	3		5	6		8				PLANNED OBSOLESCENCE	SEE 33482-4840	34950-0810	34950-0820
KEY A, BLACK	33482-0841	A-BLK	GCP	PLR	M-R						6	7					PLANNED OBSOLESCENCE	SEE 33482-4841	34950-0810	34950-0820
KEY A, BLACK	33482-0842	A-BLK	GCP	PLR	M-R							7					PLANNED OBSOLESCENCE	SEE 33482-4842	34950-0810	34950-0820
KEY A, BLACK	33482-0843	A-BLK	GCP	PLR	M-R				4			7					PLANNED OBSOLESCENCE	SEE 33482-4843	34950-0810	34950-0820
KEY A, BLACK	33482-0844	A-BLK	GCP	PLR	M-R			3			6						PLANNED OBSOLESCENCE	SEE 33482-4844	34950-0810	34950-0820
KEY A, BLACK	33482-0845	A-BLK	GCP	PLR	M-R		2	3	4	5	6						PLANNED OBSOLESCENCE	SEE 33482-4845	34950-0810	34950-0820
KEY A, BLACK	33482-0846	A-BLK	GCP	PLR	M-R				4	5		7	8				PLANNED OBSOLESCENCE	SEE 33482-4846	34950-0810	34950-0820
KEY B, LIGHT GRAY	33482-0847	B-LG	GCP	PLR	M-R	1	2	3	4	5	6	7	8				PLANNED OBSOLESCENCE	SEE 33482-4847	34950-0810	34950-0820
KEY A, BLACK	33482-0848	A-BLK	GCP	PLR	M-R	1				5							PLANNED OBSOLESCENCE	SEE 33482-4848	34950-0810	34950-0820

MX150 2X4 BLADE SEALED ASSEMBLY MAT SEAL
BOM AND PIN OUT SHEET

Table with columns: ASSEMBLY DESCRIPTION, ASSEMBLY PART NUMBER, COMPONENT (HOUSING KEY/COLOR, GROMMET CAP, PLR, MAT SEAL), BLOCKED TERMINALS (1-8), STATUS, COMMENTS, OPTIONAL ATTACHMENTS SOLD SEPERATELY (BACKSHELL WITH RIBS, BACKSHELL WITHOUT RIBS).

MX150 2X4 BLADE SEALED ASSEMBLY MAT SEAL
BOM AND PIN OUT SHEET

ASSEMBLY DESCRIPTION	ASSEMBLY PART NUMBER	COMPONENT				BLOCKED TERMINALS												STATUS	COMMENTS	OPTIONAL ATTACHMENTS SOLD SEPERATELY	
		THE PRESENCE OF AN ABBREVIATION INDICATES THE PRESENCE OF THAT COMPONENT.				CAVITY WITH A NUMBER INDICATES BLOCKED TERMINAL POSITION CAVITY WITHOUT A NUMBER INDICATES OPEN TERMINAL POSITION														BACKSHELL WITH RIBS	BACKSHELL WITHOUT RIBS
		HOUSING KEY/COLOR	GROMMET CAP	PLR	MAT SEAL	1	2	3	4	5	6	7	8								
KEY A, BLACK	33482-4841	A-BLK	GCP	PLR	M-B						6	7					SALEABLE		34950-0810	34950-0820	
KEY A, BLACK	33482-4842	A-BLK	GCP	PLR	M-B							7					SALEABLE		34950-0810	34950-0820	
KEY A, BLACK	33482-4843	A-BLK	GCP	PLR	M-B				4			7					SALEABLE		34950-0810	34950-0820	
KEY A, BLACK	33482-4844	A-BLK	GCP	PLR	M-B			3			6						SALEABLE		34950-0810	34950-0820	
KEY A, BLACK	33482-4845	A-BLK	GCP	PLR	M-B		2	3	4	5	6						SALEABLE		34950-0810	34950-0820	
KEY A, BLACK	33482-4846	A-BLK	GCP	PLR	M-B				4	5			7	8			SALEABLE		34950-0810	34950-0820	
KEY B, LIGHT GRAY	33482-4847	B-LG	GCP	PLR	M-B	1	2	3	4	5	6	7	8				SALEABLE		34950-0810	34950-0820	
KEY A, BLACK	33482-4848	A-BLK	GCP	PLR	M-B	1				5							SALEABLE		34950-0810	34950-0820	
KEY B, LIGHT GRAY	33482-4849	B-LG	GCP	PLR	M-B	1					6						SALEABLE		34950-0810	34950-0820	
KEY A, YELLOW	33482-4850	A-YW	GCP	PLR	M-B	1			4								SALEABLE		34950-0810	34950-0820	
KEY A, YELLOW	33482-4851	A-YW	GCO	PLR	M-B												SALEABLE		34950-0810	34950-0820	
KEY C, DARK GRAY	33482-4852	C-DG	GCO	PLR	M-B												SALEABLE		34950-0810	34950-0820	
KEY D, STONE GRAY	33482-4853	D-SG	GCO	PLR	M-B												SALEABLE		34950-0810	34950-0820	
KEY A, BLACK	33482-4854	A-BLK	GCP	PLR	M-B	1	2	3	4								SALEABLE		34950-0810	34950-0820	
KEY A, BLACK	33482-4855	A-BLK	GCP	PLR	M-B	1	2			5	6	7	8				SALEABLE		34950-0810	34950-0820	
KEY A, BLACK	33482-4856	A-BLK	GCP	PLR	M-B	1	2										SALEABLE		34950-0810	34950-0820	
KEY A, BLACK	33482-4857	A-BLK	GCP	PLR	M-B	1	2	3		5							SALEABLE		34950-0810	34950-0820	
KEY A, BLACK	33482-4858	A-BLK	GCP	PLR	M-B	1	2	3	4	5			8				SALEABLE		34950-0810	34950-0820	
KEY A, BLACK	33482-4859	A-BLK	GCP	PLR	M-B	1		3		5	6	7					SALEABLE		34950-0810	34950-0820	
KEY A, BLACK	33482-4860	A-BLK	GCP	PLR	M-B	1	2	3	4	5	6						SALEABLE		34950-0810	34950-0820	
KEY A, BLACK	33482-4861	A-BLK	GCP	PLR	M-B	1	2	3			6						SALEABLE		34950-0810	34950-0820	
KEY A, BLACK	33482-4862	A-BLK	GCP	PLR	M-B	1					6						SALEABLE		34950-0810	34950-0820	
KEY A, BLACK	33482-4863	A-BLK	GCP	PLR	M-B	1					6	7	8				SALEABLE		34950-0810	34950-0820	
KEY A, BLACK	33482-4864	A-BLK	GCP	PLR	M-B			3	4	5	6	7	8				SALEABLE		34950-0810	34950-0820	
KEY A, BLACK	33482-4865	A-BLK	GCP	PLR	M-B				4			7	8				SALEABLE		34950-0810	34950-0820	
KEY A, BLACK	33482-4866	A-BLK	GCP	PLR	M-B				4	5	6	7	8				SALEABLE		34950-0810	34950-0820	
KEY A, BLACK	33482-4867	A-BLK	GCP	PLR	M-B		2	3	4		6	7	8				SALEABLE		34950-0810	34950-0820	
KEY A, BLACK	33482-4868	A-BLK	GCP	PLR	M-B					5	6	7					SALEABLE		34950-0810	34950-0820	
KEY A, BLACK	33482-4869	A-BLK	GCP	PLR	M-B			3	4								SALEABLE		34950-0810	34950-0820	
KEY A, BLACK	33482-4870	A-BLK	GCP	PLR	M-B						6	7	8				SALEABLE		34950-0810	34950-0820	
KEY B, LIGHT GRAY	33482-4871	B-LG	GCP	PLR	M-B							7	8				SALEABLE		34950-0810	34950-0820	
KEY A, BLACK	33482-4872	A-BLK	GCP	PLR	M-B	1							8				SALEABLE		34950-0810	34950-0820	
KEY A, BLACK	33482-4873	A-BLK	GCP	PLR	M-B						6		8				SALEABLE		34950-0810	34950-0820	
KEY A, BLACK	33482-4874	A-BLK	GCP	PLR	M-B		2			5							SALEABLE		34950-0810	34950-0820	
KEY A, BLACK	33482-4875	A-BLK	GCP	PLR	M-B					5							SALEABLE		34950-0810	34950-0820	
KEY B, LIGHT GRAY	33482-4876	B-LG	GCP	PLR	M-B	1		3					8				SALEABLE		34950-0810	34950-0820	
KEY B, LIGHT GRAY	33482-4877	B-LG	GCP	PLR	M-B			3					8				SALEABLE		34950-0810	34950-0820	
KEY B, LIGHT GRAY	33482-4878	B-LG	GCP	PLR	M-B	1											SALEABLE		34950-0810	34950-0820	
KEY A, BLACK	33482-4879	A-BLK	GCP	PLR	M-B	1	2	3	4	5		7					SALEABLE		34950-0810	34950-0820	
KEY A, BLACK	33482-4880	A-BLK	GCP	PLR	M-B	1											SALEABLE		34950-0810	34950-0820	
KEY A, BLACK	33482-4881	A-BLK	GCP	PLR	M-B					5			8				SALEABLE		34950-0810	34950-0820	
KEY A, BLACK	33482-4882	A-BLK	GCP	PLR	M-B				4		6						SALEABLE		34950-0810	34950-0820	
KEY A, BLACK	33482-4883	A-BLK	GCP	PLR	M-B	1						7					SALEABLE		34950-0810	34950-0820	

MX150 2X6 BLADE SEALED ASSY MAT SEAL
BOM AND PIN OUT SHEET

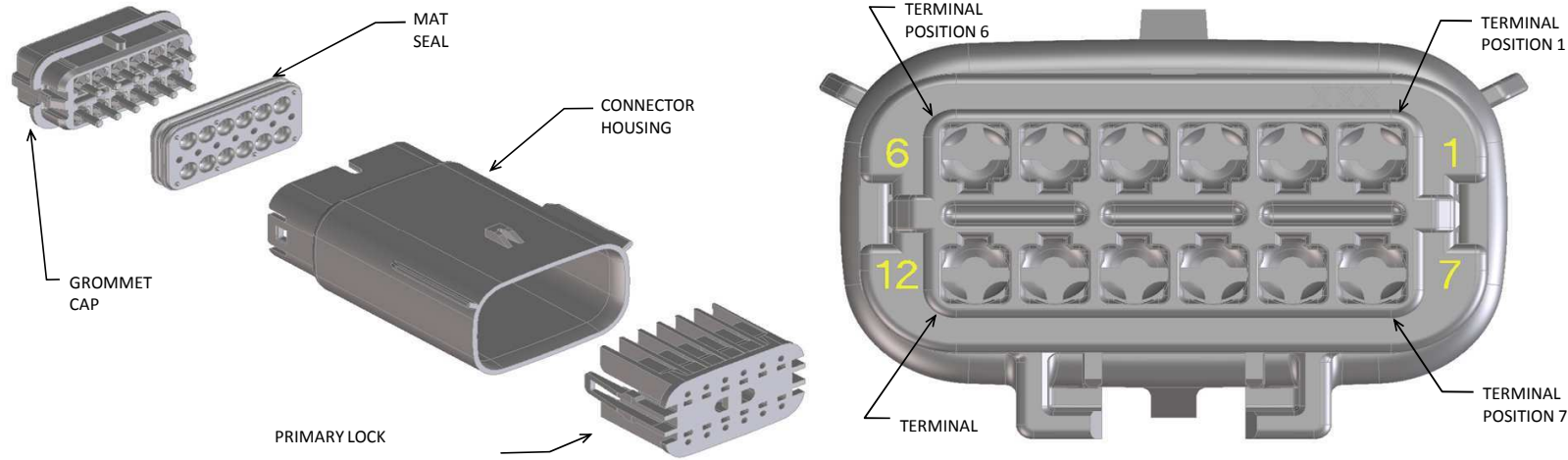

ABBREVIATION	DESCRIPTION	COLOR	MATERIAL
A-BLK	HOUSING, KEYING OPTION A	BLACK	SPS/NYLON GF20
B-LG	HOUSING, KEYING OPTION B	LIGHT GRAY	SPS/NYLON GF20
C-BR	HOUSING, KEYING OPTION C	BROWN	SPS/NYLON GF20
D-GR	HOUSING, KEYING OPTION D	GREEN	SPS/NYLON GF20
A-YL	HOUSING, KEYING OPTION A	YELLOW	SPS/NYLON GF20
C-DG	HOUSING, KEYING OPTION C	DARK GRAY	SPS/NYLON GF20
D-SG	HOUSING, KEYING OPTION D	STONE GRAY	SPS/NYLON GF20
GCP	GROMMET CAP (PLUGGED)	BLACK	SPS/NYLON GF20
PLR	PLR	NATURAL	SPS/NYLON GF20
M-R	MAT SEAL	RUST RED	INHERENTLY LUBRICATED SILICONE
M-B	MAT SEAL	ROYAL BLUE	INHERENTLY LUBRICATED SILICONE

FOR ADDITIONAL INFORMATION SEE SD-33482-0001

ASSEMBLY DESCRIPTION	ASSEMBLY PART NUMBER	COMPONENT				BLOCKED TERMINALS												STATUS	COMMENTS	OPTIONAL ATTACHMENTS SOLD SEPERATELY		
		THE PRESENCE OF AN ABBREVIATION INDICATES THE PRESENCE OF THAT COMPONENT.				CAVITY WITH A NUMBER INDICATES BLOCKED TERMINAL POSITION CAVITY WITHOUT A NUMBER INDICATES OPEN TERMINAL POSITION														BACKSHELL WITH RIBS	BACKSHELL WITHOUT RIBS	
		HOUSING KEY/COLOR	GROMMET CAP	PLR	MAT SEAL	1	2	3	4	5	6	7	8	9	10	11	12					
KEY A, BLACK	33482-1201	A-BLK	GCP	PLR	M-R														PLANNED OBSOLESCE	SEE 33482-6201	34950-1210	34950-1220
KEY B, LIGHT GRAY	33482-1202	B-LG	GCP	PLR	M-R														PLANNED OBSOLESCE	SEE 33482-6202	34950-1210	34950-1220
KEY C, BROWN	33482-1203	C-BR	GCP	PLR	M-R														PLANNED OBSOLESCE	SEE 33482-6203	34950-1210	34950-1220
KEY D, GREEN	33482-1204	D-GR	GCP	PLR	M-R														PLANNED OBSOLESCE	SEE 33482-6204	34950-1210	34950-1220
VOID KEY	33482-1205																					
KEY A, BLACK	33482-1206	A-BLK	GCP	PLR	M-R						6								PLANNED OBSOLESCE	SEE 33482-6206	34950-1210	34950-1220
KEY B, LIGHT GRAY	33482-1207	B-LG	GCP	PLR	M-R						6								PLANNED OBSOLESCE	SEE 33482-6207	34950-1210	34950-1220
KEY C, BROWN	33482-1208	C-BR	GCP	PLR	M-R						6								PLANNED OBSOLESCE	SEE 33482-6208	34950-1210	34950-1220
KEY D, GREEN	33482-1209	D-GR	GCP	PLR	M-R						6								PLANNED OBSOLESCE	SEE 33482-6209	34950-1210	34950-1220
VOID KEY	33482-1210																					
KEY A, BLACK	33482-1211	A-BLK	GCP	PLR	M-R						6	7							PLANNED OBSOLESCE	SEE 33482-6211	34950-1210	34950-1220
KEY B, LIGHT GRAY	33482-1212	B-LG	GCP	PLR	M-R						6	7							PLANNED OBSOLESCE	SEE 33482-6212	34950-1210	34950-1220
KEY C, BROWN	33482-1213	C-BR	GCP	PLR	M-R						6	7							PLANNED OBSOLESCE	SEE 33482-6213	34950-1210	34950-1220
KEY D, GREEN	33482-1214	D-GR	GCP	PLR	M-R						6	7							PLANNED OBSOLESCE	SEE 33482-6214	34950-1210	34950-1220
VOID KEY	33482-1215																					
KEY A, BLACK	33482-1216	A-BLK	GCP	PLR	M-R	1					6	7							PLANNED OBSOLESCE	SEE 33482-6216	34950-1210	34950-1220
KEY B, LIGHT GRAY	33482-1217	B-LG	GCP	PLR	M-R	1					6	7							PLANNED OBSOLESCE	SEE 33482-6217	34950-1210	34950-1220
KEY C, BROWN	33482-1218	C-BR	GCP	PLR	M-R	1					6	7							PLANNED OBSOLESCE	SEE 33482-6218	34950-1210	34950-1220
KEY D, GREEN	33482-1219	D-GR	GCP	PLR	M-R	1					6	7							PLANNED OBSOLESCE	SEE 33482-6219	34950-1210	34950-1220
VOID KEY	33482-1220																					
KEY A, BLACK	33482-1221	A-BLK	GCP	PLR	M-R	1					6	7					12		PLANNED OBSOLESCE	SEE 33482-6221	34950-1210	34950-1220
KEY B, LIGHT GRAY	33482-1222	B-LG	GCP	PLR	M-R	1					6	7					12		PLANNED OBSOLESCE	SEE 33482-6222	34950-1210	34950-1220
KEY C, BROWN	33482-1223	C-BR	GCP	PLR	M-R	1					6	7					12		PLANNED OBSOLESCE	SEE 33482-6223	34950-1210	34950-1220
KEY D, GREEN	33482-1224	D-GR	GCP	PLR	M-R	1					6	7					12		PLANNED OBSOLESCE	SEE 33482-6224	34950-1210	34950-1220
VOID KEY	33482-1225																					
KEY A, BLACK	33482-1226	A-BLK	GCP	PLR	M-R						6						12		PLANNED OBSOLESCE	SEE 33482-6226	34950-1210	34950-1220
KEY A, BLACK	33482-1227	A-BLK	GCP	PLR	M-R	1	2	3	4	5	6	7	8	9	10	11	12		PLANNED OBSOLESCE	SEE 33482-6227	34950-1210	34950-1220
KEY B, LIGHT GRAY	33482-1228	B-LG	GCP	PLR	M-R	1	2	3	4	5	6	7	8	9	10	11	12		PLANNED OBSOLESCE	SEE 33482-6228	34950-1210	34950-1220
KEY C, BROWN	33482-1229	C-BR	GCP	PLR	M-R	1	2	3	4	5	6	7	8	9	10	11	12		PLANNED OBSOLESCE	SEE 33482-6229	34950-1210	34950-1220
KEY D, GREEN	33482-1230	D-GR	GCP	PLR	M-R	1	2	3	4	5	6	7	8	9	10	11	12		PLANNED OBSOLESCE	SEE 33482-6230	34950-1210	34950-1220
VOID KEY	33482-1231																					
KEY A, BLACK	33482-1232	A-BLK	GCP	PLR	M-R		2	3					8				11		PLANNED OBSOLESCE	SEE 33482-6232	34950-1210	34950-1220
KEY A, BLACK	33482-1233	A-BLK	GCP	PLR	M-R		2	3			5	6	7	8			11		PLANNED OBSOLESCE	SEE 33482-6233	34950-1210	34950-1220
KEY A, BLACK	33482-1234	A-BLK	GCP	PLR	M-R						6	7							PLANNED OBSOLESCE	SEE 33482-6234	34950-1210	34950-1220
KEY A, BLACK	33482-1235	A-BLK	GCP	PLR	M-R		2	3			6	7	8			10	11		PLANNED OBSOLESCE	SEE 33482-6235	34950-1210	34950-1220
KEY B, LIGHT GRAY	33482-1236	B-LG	GCP	PLR	M-R	1					5	6	7	8	9	10			PLANNED OBSOLESCE	SEE 33482-6236	34950-1210	34950-1220
KEY A, BLACK	33482-1237	A-BLK	GCP	PLR	M-R														PLANNED OBSOLESCE	SEE 33482-6237	34950-1210	34950-1220
KEY B, LIGHT GRAY	33482-1238	B-LG	GCP	PLR	M-R		2							9	10				PLANNED OBSOLESCE	SEE 33482-6238	34950-1210	34950-1220
KEY A, BLACK	33482-1239	A-BLK	GCP	PLR	M-R	1					5	6	7	8	9	10	11		PLANNED OBSOLESCE	SEE 33482-6239	34950-1210	34950-1220
KEY A, BLACK	33482-1240	A-BLK	GCP	PLR	M-R		2	3					8	9	10	11			PLANNED OBSOLESCE	SEE 33482-6240	34950-1210	34950-1220
KEY A, BLACK	33482-1241	A-BLK	GCP	PLR	M-R								7	8	9	10	11		PLANNED OBSOLESCE	SEE 33482-6241	34950-1210	34950-1220
KEY A, BLACK	33482-1242	A-BLK	GCP	PLR	M-R								7	8					PLANNED OBSOLESCE	SEE 33482-6242	34950-1210	34950-1220
KEY A, BLACK	33482-1243	A-BLK	GCP	PLR	M-R		2							9	10				PLANNED OBSOLESCE	SEE 33482-6243	34950-1210	34950-1220
KEY A, BLACK	33482-1244	A-BLK	GCP	PLR	M-R		2				4								PLANNED OBSOLESCE	SEE 33482-6244	34950-1210	34950-1220
KEY A, BLACK	33482-1245	A-BLK	GCP	PLR	M-R									9	10	11	12		PLANNED OBSOLESCE	SEE 33482-6245	34950-1210	34950-1220
KEY A, BLACK	33482-1246	A-BLK	GCP	PLR	M-R												11		PLANNED OBSOLESCE	SEE 33482-6246	34950-1210	34950-1220
KEY A, BLACK	33482-1247	A-BLK	GCP	PLR	M-R		2	3	4				7	8					PLANNED OBSOLESCE	SEE 33482-6247	34950-1210	34950-1220
KEY A, BLACK	33482-1248	A-BLK	GCP	PLR	M-R	1			3	4	5	6	7	8					PLANNED OBSOLESCE	SEE 33482-6248	34950-1210	34950-1220
KEY A, BLACK	33482-1249	A-BLK	GCP	PLR	M-R										10	11	12		PLANNED OBSOLESCE	SEE 33482-6249	34950-1210	34950-1220
KEY A, BLACK	33482-1250	A-BLK	GCP	PLR	M-R					4	5	6	7	8	9				PLANNED OBSOLESCE	SEE 33482-6250	34950-1210	34950-1220
KEY A, BLACK	33482-1251	A-BLK	GCP	PLR	M-R		2			4	5				10	11			PLANNED OBSOLESCE	SEE 33482-6251	34950-1210	34950-1220
KEY A, BLACK	33482-1252	A-BLK	GCP	PLR	M-R								7						PLANNED OBSOLESCE	SEE 33482-6252	34950-1210	34950-1220
KEY A, BLACK	33482-1253	A-BLK	GCP	PLR	M-R		2	3	4	5	6	7	8			10	11	12	PLANNED OBSOLESCE	SEE 33482-6253	34950-1210	34950-1220
KEY A, BLACK	33482-1254	A-BLK	GCP	PLR	M-R		2	3	4	5					10	11	12		PLANNED OBSOLESCE	SEE 33482-6254	34950-1210	34950-1220

MX150 2X6 BLADE SEALED ASSY MAT SEAL
BOM AND PIN OUT SHEET

ASSEMBLY DESCRIPTION	ASSEMBLY PART NUMBER	COMPONENT				BLOCKED TERMINALS												STATUS	COMMENTS	OPTIONAL ATTACHMENTS SOLD SEPERATELY			
		THE PRESENCE OF AN ABBREVIATION INDICATES THE PRESENCE OF THAT COMPONENT.				CAVITY WITH A NUMBER INDICATES BLOCKED TERMINAL POSITION CAVITY WITHOUT A NUMBER INDICATES OPEN TERMINAL POSITION														BACKSHELL WITH RIBS	BACKSHELL WITHOUT RIBS		
		HOUSING KEY/COLOR	GROMMET CAP	PLR	MAT SEAL	1	2	3	4	5	6	7	8	9	10	11	12						
KEY A, BLACK	33482-1255	A-BLK	GCP	PLR	M-R		2	3	4	5	6	7		9	10	11	12	PLANNED OBSOLESCENCE	SEE 33482-6255	34950-1210	34950-1220		
KEY A, BLACK	33482-1256	A-BLK	GCP	PLR	M-R	1					6	7						PLANNED OBSOLESCENCE	SEE 33482-6256	34950-1210	34950-1220		
KEY A, BLACK	33482-1257	A-BLK	GCP	PLR	M-R									9	10		12	PLANNED OBSOLESCENCE	SEE 33482-6257	34950-1210	34950-1220		
KEY A, BLACK	33482-1258	A-BLK	GCP	PLR	M-R		2	3								11		PLANNED OBSOLESCENCE	SEE 33482-6258	34950-1210	34950-1220		
KEY A, BLACK	33482-1259	A-BLK	GCP	PLR	M-R	1	2	3	4	5				9	10	11	12	PLANNED OBSOLESCENCE	SEE 33482-6259	34950-1210	34950-1220		
KEY A, BLACK	33482-1260	A-BLK	GCP	PLR	M-R										11	12		PLANNED OBSOLESCENCE	SEE 33482-6260	34950-1210	34950-1220		
KEY C, DARK GRAY	33482-1261	C-DG	GCP	PLR	M-R													PLANNED OBSOLESCENCE	SEE 33482-6261	34950-1210	34950-1220		
KEY D, STONE GRAY	33482-1262	D-SG	GCP	PLR	M-R													PLANNED OBSOLESCENCE	SEE 33482-6262	34950-1210	34950-1220		
KEY C, DARK GRAY	33482-1263	C-DG	GCP	PLR	M-R	1	2	3	4	5	6	7	8	9	10	11	12	PLANNED OBSOLESCENCE	SEE 33482-6263	34950-1210	34950-1220		
KEY D, STONE GRAY	33482-1264	D-SG	GCP	PLR	M-R	1	2	3	4	5	6	7	8	9	10	11	12	PLANNED OBSOLESCENCE	SEE 33482-6264	34950-1210	34950-1220		
KEY A, BLACK	33482-1265	A-BLK	GCP	PLR	M-R						6	7	8	9	10	11		PLANNED OBSOLESCENCE	SEE 33482-6265	34950-1210	34950-1220		
KEY A, BLACK	33482-1266	A-BLK	GCP	PLR	M-R	1	2	3	4	5	6	7				12		PLANNED OBSOLESCENCE	SEE 33482-6266	34950-1210	34950-1220		
KEY A, BLACK	33482-1267	A-BLK	GCP	PLR	M-R			3	4	5	6	7						PLANNED OBSOLESCENCE	SEE 33482-6267	34950-1210	34950-1220		
KEY A, BLACK	33482-1268	A-BLK	GCP	PLR	M-R			3	4	5	6	7	8	9	10	11		PLANNED OBSOLESCENCE	SEE 33482-6268	34950-1210	34950-1220		
KEY A, BLACK	33482-1269	A-BLK	GCP	PLR	M-R	1	2	3	4	5			8	9	10	11	12	PLANNED OBSOLESCENCE	SEE 33482-6269	34950-1210	34950-1220		
KEY A, BLACK	33482-1270	A-BLK	GCP	PLR	M-R		2		4				7	8	9	10		PLANNED OBSOLESCENCE	SEE 33482-6270	34950-1210	34950-1220		
KEY A, BLACK	33482-1271	A-BLK	GCP	PLR	M-R		2						7	8	9			PLANNED OBSOLESCENCE	SEE 33482-6271	34950-1210	34950-1220		
KEY A, BLACK	33482-1272	A-BLK	GCP	PLR	M-R		2						7	8	9	10		PLANNED OBSOLESCENCE	SEE 33482-6272	34950-1210	34950-1220		
KEY A, BLACK	33482-1273	A-BLK	GCP	PLR	M-R								8					PLANNED OBSOLESCENCE	SEE 33482-6273	34950-1210	34950-1220		
KEY A, BLACK	33482-1274	A-BLK	GCP	PLR	M-R	1			3	4	5	6			8	10	11	12	PLANNED OBSOLESCENCE	SEE 33482-6274	34950-1210	34950-1220	
KEY A, BLACK	33482-1275	A-BLK	GCP	PLR	M-R				4					8		10		PLANNED OBSOLESCENCE	SEE 33482-6275	34950-1210	34950-1220		
KEY A, BLACK	33482-1276	A-BLK	GCP	PLR	M-R	1	2	3	4		6			8		10	11	12	PLANNED OBSOLESCENCE	SEE 33482-6276	34950-1210	34950-1220	
KEY A, BLACK	33482-1277	A-BLK	GCP	PLR	M-R	1	2	3							11	12		PLANNED OBSOLESCENCE	SEE 33482-6277	34950-1210	34950-1220		
KEY A, BLACK	33482-1278	A-BLK	GCP	PLR	M-R						6					12		PLANNED OBSOLESCENCE	SEE 33482-6278	34950-1210	34950-1220		
KEY A, BLACK	33482-1279	A-BLK	GCP	PLR	M-R	1	2	3	4	5			7	8	9	10	11		PLANNED OBSOLESCENCE	SEE 33482-6279	34950-1210	34950-1220	
KEY A, BLACK	33482-1280	A-BLK	GCP	PLR	M-R	1	2	3	4	5	6			9				PLANNED OBSOLESCENCE	SEE 33482-6280	34950-1210	34950-1220		
KEY A, BLACK	33482-1281	A-BLK	GCP	PLR	M-R		2		4		6			8		10	11		PLANNED OBSOLESCENCE	SEE 33482-6281	34950-1210	34950-1220	
KEY A, BLACK	33482-1282	A-BLK	GCP	PLR	M-R	1	2	3	4	5	6			9	10	11	12		PLANNED OBSOLESCENCE	SEE 33482-6282	34950-1210	34950-1220	
KEY A, BLACK	33482-1283	A-BLK	GCP	PLR	M-R						6			9	10	11	12		PLANNED OBSOLESCENCE	SEE 33482-6283	34950-1210	34950-1220	
KEY A, BLACK	33482-1284	A-BLK	GCP	PLR	M-R	1			3	4	5	6	7	8		10	11	12		PLANNED OBSOLESCENCE	SEE 33482-6284	34950-1210	34950-1220
KEY D, STONE GRAY	33482-1285	D-SG	GCP	PLR	M-R	1					6	7						PLANNED OBSOLESCENCE	SEE 33482-6285	34950-1210	34950-1220		
KEY A, BLACK	33482-1286	A-BLK	GCP	PLR	M-R		2	3					7	8	9			PLANNED OBSOLESCENCE	SEE 33482-6286	34950-1210	34950-1220		
KEY A, BLACK	33482-1287	A-BLK	GCP	PLR	M-R	1							7					PLANNED OBSOLESCENCE	SEE 33482-6287	34950-1210	34950-1220		
KEY A, BLACK	33482-1288	A-BLK	GCP	PLR	M-R	1							6					PLANNED OBSOLESCENCE	SEE 33482-6288	34950-1210	34950-1220		
KEY A, BLACK	33482-1289	A-BLK	GCP	PLR	M-R	1	2	3	4	5	6			8				PLANNED OBSOLESCENCE	SEE 33482-6289	34950-1210	34950-1220		
KEY A, BLACK	33482-1290	A-BLK	GCP	PLR	M-R	1							7				12	PLANNED OBSOLESCENCE	SEE 33482-6290	34950-1210	34950-1220		
KEY A, BLACK	33482-1291	A-BLK	GCP	PLR	M-R	1	2	3	4	5	6	7	8				12	PLANNED OBSOLESCENCE	SEE 33482-6291	34950-1210	34950-1220		
KEY A, BLACK	33482-1292	A-BLK	GCP	PLR	M-R									9				PLANNED OBSOLESCENCE	SEE 33482-6292	34950-1210	34950-1220		
KEY A, BLACK	33482-1293	A-BLK	GCP	PLR	M-R				3	4				9	10	11	12	PLANNED OBSOLESCENCE	SEE 33482-6293	34950-1210	34950-1220		
KEY A, BLACK	33482-1294	A-BLK	GCP	PLR	M-R	1	2				5	6	7	8				PLANNED OBSOLESCENCE	SEE 33482-6294	34950-1210	34950-1220		
KEY A, BLACK	33482-1295	A-BLK	GCP	PLR	M-R	1	2				5	6	7	8		11	12	PLANNED OBSOLESCENCE	SEE 33482-6295	34950-1210	34950-1220		
KEY A, BLACK	33482-1296	A-BLK	GCP	PLR	M-R	1	2	3	4	5	6	7	8	9	10			PLANNED OBSOLESCENCE	SEE 33482-6296	34950-1210	34950-1220		
KEY A, BLACK	33482-1297	A-BLK	GCP	PLR	M-R				4		6				10	11	12	PLANNED OBSOLESCENCE	SEE 33482-6297	34950-1210	34950-1220		
KEY A, BLACK	33482-1298	A-BLK	GCP	PLR	M-R						6				11	12		PLANNED OBSOLESCENCE	SEE 33482-6298	34950-1210	34950-1220		
KEY A, BLACK	33482-1299	A-BLK	GCP	PLR	M-R	1	2						7	8				PLANNED OBSOLESCENCE	SEE 33482-6299	34950-1210	34950-1220		
KEY A, BLACK	33482-1300	A-BLK	GCP	PLR	M-R	1	2	3						8		10	11	12	PLANNED OBSOLESCENCE	SEE 33482-6300	34950-1210	34950-1220	
KEY A, BLACK	33482-1301	A-BLK	GCP	PLR	M-R	1	2						7	8			12	PLANNED OBSOLESCENCE	SEE 33482-6301	34950-1210	34950-1220		
KEY B, LIGHT GRAY	33482-1302	B-LG	GCP	PLR	M-R										10	11		PLANNED OBSOLESCENCE	SEE 33482-6302	34950-1210	34950-1220		
KEY A, BLACK	33482-1303	A-BLK	GCP	PLR	M-R	1	2	3	4				7	8	9	10		12	PLANNED OBSOLESCENCE	SEE 33482-6303	34950-1210	34950-1220	
KEY A, BLACK	33482-1304	A-BLK	GCP	PLR	M-R	1	2	3	4				7	8	9	10		PLANNED OBSOLESCENCE	SEE 33482-6304	34950-1210	34950-1220		
KEY B, LIGHT GRAY	33482-1305	B-LG	GCP	PLR	M-R										10	11	12	PLANNED OBSOLESCENCE	SEE 33482-6305	34950-1210	34950-1220		
KEY B, LIGHT GRAY	33482-1306	B-LG	GCP	PLR	M-R	1	2	3	4	5	6	7	8	9	10	11	12	PLANNED OBSOLESCENCE	SEE 33482-6306	34950-1210	34950-1220		
KEY A, BLACK	33482-1307	A-BLK	GCP	PLR	M-R	1	2	3	4	5			7	8				PLANNED OBSOLESCENCE	SEE 33482-6307	34950-1210	34950-1220		
KEY A, BLACK	33482-1308	A-BLK	GCP	PLR	M-R								7	8	9	10	11	12	PLANNED OBSOLESCENCE	SEE 33482-6308	34950-1210	34950-1220	
KEY A, BLACK	33482-1309	A-BLK	GCP	PLR	M-R	1								8		10	11		PLANNED OBSOLESCENCE	SEE 33482-6309	34950-1210	34950-1220	
KEY A, BLACK	33482-1310	A-BLK	GCP	PLR	M-R	1			4							11		PLANNED OBSOLESCENCE	SEE 33482-6310	34950-1210	34950-1220		
KEY A, BLACK	33482-1311	A-BLK	GCP	PLR	M-R	1	2		4	5	6	7		9	10	11	12	PLANNED OBSOLESCENCE	SEE 33482-6311	34950-1210	34950-1220		
KEY A, BLACK	33482-1312	A-BLK	GCP	PLR	M-R								8	9				PLANNED OBSOLESCENCE	SEE 33482-6312	34950-1210	34950-1220		
KEY A, BLACK	33482-1313	A-BLK	GCP	PLR	M-R				3	4	5	6		8	9	10	11		PLANNED OBSOLESCENCE	SEE 33482-6313	34950-1210	34950-1220	
KEY A, BLACK	33482-1314	A-BLK	GCP	PLR	M-R				3			6	7	8	9	10		PLANNED OBSOLESCENCE	SEE 33482-6314	34950-1210	34950-1220		
KEY A, BLACK	33482-1315	A-BLK	GCP	PLR	M-R						6	7	8	9				PLANNED OBSOLESCENCE	SEE 33482-6315	34950-1210	34950-1220		
KEY A, BLACK	33482-1316	A-BLK	GCP	PLR	M-R						5	6	7	8				PLANNED OBSOLESCENCE	SEE 33482-6316	34950-1210	34950-1220		
KEY A, BLACK	33482-1317	A-BLK	GCP	PLR	M-R	1	2									11		PLANNED OBSOLESCENCE	SEE 33482-6317	34950-1210	34950-1220		
KEY A, BLACK	33482-1318	A-BLK	GCP	PLR	M-R	1	2	3	4	5	6	7	8					PLANNED OBSOLESCENCE	SEE 33482-6318	34950-1210	34950-1220		
KEY A, BLACK	33482-1319	A-BLK	GCP	PLR	M-R	1	2	3	4	5	6	7	8	9				PLANNED OBSOLESCENCE	SEE 33482-6319	34950-1210	34950-1220		
KEY C, DARK GRAY	33482-1320	C-DG	GCP	PLR	M-R	1					6	7						PLANNED OBSOLESCENCE	SEE 33482-6320	34950-1210	34950-1220		
KEY C, BROWN	33482-1321	C-BR	GCP	PLR	M-R	1	2	3	4	5	6							PLANNED OBSOLESCENCE	SEE 33482-6321	34950-1210	34950-1220		
KEY C, BROWN	33482-1322	C-BR	GCP	PLR	M-R	1	2				5	6											

MX150 2X6 BLADE SEALED ASSY MAT SEAL
BOM AND PIN OUT SHEET

Table with columns: ASSEMBLY DESCRIPTION, ASSEMBLY PART NUMBER, COMPONENT (HOUSING KEY/COLOR, GROMMET CAP, PLR, MAT SEAL), BLOCKED TERMINALS (1-12), STATUS, COMMENTS, and OPTIONAL ATTACHMENTS SOLD SEPERATELY (BACKSHELL WITH RIBS, BACKSHELL WITHOUT RIBS). Rows list various assembly parts like KEY A, BLACK and KEY B, LIGHT GRAY with their respective specifications and terminal positions.

MX150 2X6 BLADE SEALED ASSY MAT SEAL
BOM AND PIN OUT SHEET

Table with columns: ASSEMBLY DESCRIPTION, ASSEMBLY PART NUMBER, COMPONENT (HOUSING KEY/COLOR, GROMMET CAP, PLR, MAT SEAL), BLOCKED TERMINALS (1-12), STATUS, COMMENTS, and OPTIONAL ATTACHMENTS SOLD SEPERATELY (BACKSHELL WITH RIBS, BACKSHELL WITHOUT RIBS).

MX150 2X6 BLADE SEALED ASSY MAT SEAL
BOM AND PIN OUT SHEET

ASSEMBLY DESCRIPTION	ASSEMBLY PART NUMBER	COMPONENT				BLOCKED TERMINALS												STATUS	COMMENTS	OPTIONAL ATTACHMENTS SOLD SEPERATELY		
		THE PRESENCE OF AN ABBREVIATION INDICATES THE PRESENCE OF THAT COMPONENT.				CAVITY WITH A NUMBER INDICATES BLOCKED TERMINAL POSITION CAVITY WITHOUT A NUMBER INDICATES OPEN TERMINAL POSITION														BACKSHELL WITH RIBS	BACKSHELL WITHOUT RIBS	
		HOUSING KEY/COLOR	GROMMET CAP	PLR	MAT SEAL	1	2	3	4	5	6	7	8	9	10	11	12					
KEY A, BLACK	33482-6413	A-BLK	GCP	PLR	M-B	1		3		5						11		SALEABLE		34950-1210	34950-1220	
KEY A, BLACK	33482-6414	A-BLK	GCP	PLR	M-B	1		3		5			8		10		11		SALEABLE		34950-1210	34950-1220
KEY A, BLACK	33482-6415	A-BLK	GCP	PLR	M-B		2	3		5	6	7		9		11	12		SALEABLE		34950-1210	34950-1220
KEY A, BLACK	33482-6416	A-BLK	GCP	PLR	M-B	1			4	5	6		8		10		12		SALEABLE		34950-1210	34950-1220
KEY A, BLACK	33482-6417	A-BLK	GCP	PLR	M-B	1			4	5			8		10		12		SALEABLE		34950-1210	34950-1220
KEY A, BLACK	33482-6418	A-BLK	GCP	PLR	M-B	1	2	3	4	5			8		10	11	12		SALEABLE		34950-1210	34950-1220
KEY A, BLACK	33482-6419	A-BLK	GCP	PLR	M-B		2	3		5	6	7		9	10	11	12		SALEABLE		34950-1210	34950-1220
KEY A, BLACK	33482-6420	A-BLK	GCP	PLR	M-B	1	2	3	4				8	9					SALEABLE		34950-1210	34950-1220
KEY A, BLACK	33482-6421	A-BLK	GCP	PLR	M-B		2	3						9					SALEABLE		34950-1210	34950-1220
KEY A, BLACK	33482-6422	A-BLK	GCP	PLR	M-B								8		10	11			SALEABLE		34950-1210	34950-1220
KEY A, BLACK	33482-6423	A-BLK	GCP	PLR	M-B	1		3		5						11			SALEABLE		34950-1210	34950-1220
KEY A, BLACK	33482-6424	A-BLK	GCP	PLR	M-B	1		3		5			8		10	11			SALEABLE		34950-1210	34950-1220
KEY A, BLACK	33482-6425	A-BLK	GCP	PLR	M-B		2		4		6	7	8	9	10	11	12		SALEABLE		34950-1210	34950-1220
KEY A, BLACK	33482-6426	A-BLK	GCP	PLR	M-B				3	4						11	12		SALEABLE		34950-1210	34950-1220
KEY A, BLACK	33482-6427	A-BLK	GCP	PLR	M-B				3	4				9	10	11	12		SALEABLE		34950-1210	34950-1220
KEY A, BLACK	33482-6428	A-BLK	GCP	PLR	M-B	1	2			5	6	7	8	9	10				SALEABLE		34950-1210	34950-1220
KEY A, BLACK	33482-6429	A-BLK	GCP	PLR	M-B								9	10					SALEABLE		34950-1210	34950-1220
KEY A, BLACK	33482-6430	A-BLK	GCP	PLR	M-B				3	4	5	6		8	9				SALEABLE		34950-1210	34950-1220
KEY B, LIGHT GRAY	33482-6431	B-LG	GCP	PLR	M-B	1	2	3	4				8			11	12		SALEABLE		34950-1210	34950-1220
KEY B, LIGHT GRAY	33482-6432	B-LG	GCP	PLR	M-B	1	2	3	4				8						SALEABLE		34950-1210	34950-1220
KEY A, BLACK	33482-6433	A-BLK	GCP	PLR	M-B										10	11	12		SALEABLE		34950-1210	34950-1220
KEY B, LIGHT GRAY	33482-6434	B-LG	GCP	PLR	M-B							7	8	9			12		SALEABLE		34950-1210	34950-1220
KEY A, BLACK	33482-6435	A-BLK	GCP	PLR	M-B							7	8	9	10	11	12		SALEABLE		34950-1210	34950-1220
KEY A, BLACK	33482-6436	A-BLK	GCP	PLR	M-B		2						8	9	10	11	12		SALEABLE		34950-1210	34950-1220
KEY A, BLACK	33482-6437	A-BLK	GCP	PLR	M-B		2						8	9					SALEABLE		34950-1210	34950-1220

MX150 2X8 BLADE SEALED ASSY MAT SEAL
BOM AND PIN OUT SHEET

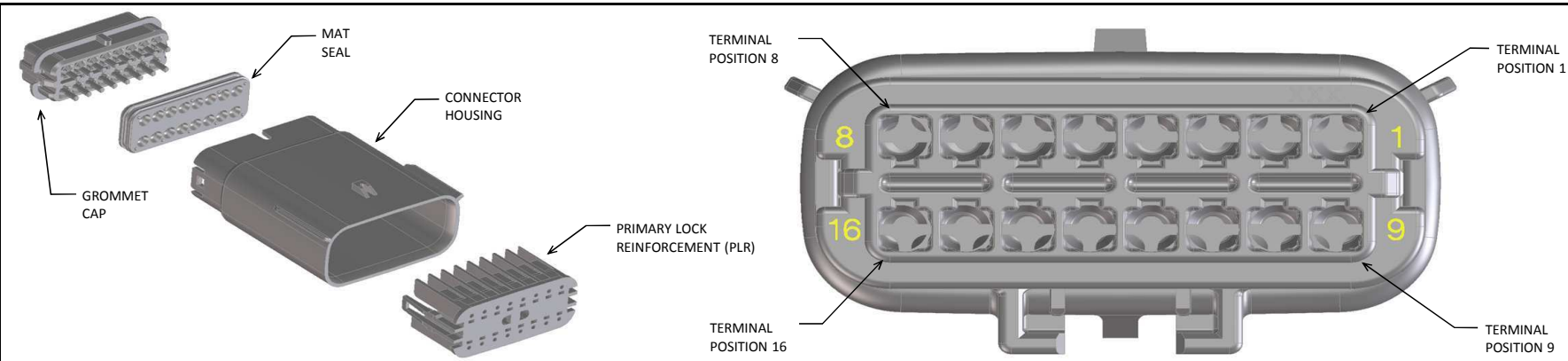

ABBREVIATION	DESCRIPTION	COLOR	MATERIAL
A-BLK	HOUSING, KEYING OPTION A	BLACK	SPS/NYLON GF20
B-LG	HOUSING, KEYING OPTION B	LIGHT GRAY	SPS/NYLON GF20
C-BR	HOUSING, KEYING OPTION C	BROWN	SPS/NYLON GF20
D-GR	HOUSING, KEYING OPTION D	GREEN	SPS/NYLON GF20
C-DG	HOUSING, KEYING OPTION C	DARK GRAY	SPS/NYLON GF20
D-SG	HOUSING, KEYING OPTION D	STONE GRAY	SPS/NYLON GF20
A-YW	HOUSING, KEYING OPTION A	YELLOW	SPS/NYLON GF20
GCP	GROMMET CAP (PLUGGED)	BLACK	SPS/NYLON GF20
PLR	PLR	NATURAL	SPS/NYLON GF20
M-R	MAT SEAL	RUST RED	INHERENTLY LUBRICATED SILICONE
M-B	MAT SEAL	ROYAL BLUE	INHERENTLY LUBRICATED SILICONE

FOR ADDITIONAL INFORMATION SEE SD-33482-0001

ASSEMBLY DESCRIPTION	ASSEMBLY PART NUMBER	COMPONENT				BLOCKED TERMINALS																STATUS	COMMENTS	OPTIONAL ATTACHMENTS SOLD SEPARATELY									
		THE PRESENCE OF AN ABBREVIATION INDICATES THE PRESENCE OF THAT COMPONENT.				CAVITY WITH A NUMBER INDICATES BLOCKED TERMINAL POSITION CAVITY WITHOUT A NUMBER INDICATES OPEN TERMINAL POSITION																		BACKSHELL WITH RIBS	BACKSHELL WITHOUT RIBS								
		HOUSING KEY/COLOR	GROMMET CAP	PLR	MAT SEAL	1	2	3	4	5	6	7	8	9	10	11	12	13	14	15	16												
KEY A, BLACK	33482-1601	A-BLK	GCP	PLR	M-R																						PLANNED OBSOLESCENCE	SEE 33482-8601					
KEY B, LIGHT GRAY	33482-1602	B-LG	GCP	PLR	M-R																							PLANNED OBSOLESCENCE	SEE 33482-8602				
KEY C, BROWN	33482-1603	C-BR	GCP	PLR	M-R																							PLANNED OBSOLESCENCE	SEE 33482-8603				
KEY D, GREEN	33482-1604	D-GR	GCP	PLR	M-R																							PLANNED OBSOLESCENCE	SEE 33482-8604				
VOID KEY	33482-1605																																
KEY A, BLACK	33482-1606	A-BLK	GCP	PLR	M-R								8															PLANNED OBSOLESCENCE	SEE 33482-8606				
KEY B, LIGHT GRAY	33482-1607	B-LG	GCP	PLR	M-R								8															PLANNED OBSOLESCENCE	SEE 33482-8607				
KEY C, BROWN	33482-1608	C-BR	GCP	PLR	M-R								8															PLANNED OBSOLESCENCE	SEE 33482-8608				
KEY D, GREEN	33482-1609	D-GR	GCP	PLR	M-R								8															PLANNED OBSOLESCENCE	SEE 33482-8609				
VOID KEY	33482-1610												8																				
KEY A, BLACK	33482-1611	A-BLK	GCP	PLR	M-R								8	9														PLANNED OBSOLESCENCE	SEE 33482-8611				
KEY B, LIGHT GRAY	33482-1612	B-LG	GCP	PLR	M-R								8	9														PLANNED OBSOLESCENCE	SEE 33482-8612				
KEY C, BROWN	33482-1613	C-BR	GCP	PLR	M-R								8	9														PLANNED OBSOLESCENCE	SEE 33482-8613				
KEY D, GREEN	33482-1614	D-GR	GCP	PLR	M-R								8	9														PLANNED OBSOLESCENCE	SEE 33482-8614				
VOID KEY	33482-1615												8	9																			
KEY A, BLACK	33482-1616	A-BLK	GCP	PLR	M-R	1							8	9														PLANNED OBSOLESCENCE	SEE 33482-8616				
KEY B, LIGHT GRAY	33482-1617	B-LG	GCP	PLR	M-R	1							8	9														PLANNED OBSOLESCENCE	SEE 33482-8617				
KEY C, BROWN	33482-1618	C-BR	GCP	PLR	M-R	1							8	9														PLANNED OBSOLESCENCE	SEE 33482-8618				
KEY D, GREEN	33482-1619	D-GR	GCP	PLR	M-R	1							8	9														PLANNED OBSOLESCENCE	SEE 33482-8619				
VOID KEY	33482-1620					1							8	9																			
KEY A, BLACK	33482-1621	A-BLK	GCP	PLR	M-R	1	2	3	4	5	6	7	8	9	10	11	12	13	14	15	16							PLANNED OBSOLESCENCE	SEE 33482-8621				
KEY B, LIGHT GRAY	33482-1622	B-LG	GCP	PLR	M-R	1	2	3	4	5	6	7	8	9	10	11	12	13	14	15	16								PLANNED OBSOLESCENCE	SEE 33482-8622			
KEY C, BROWN	33482-1623	C-BR	GCP	PLR	M-R	1	2	3	4	5	6	7	8	9	10	11	12	13	14	15	16								PLANNED OBSOLESCENCE	SEE 33482-8623			
KEY D, GREEN	33482-1624	D-GR	GCP	PLR	M-R	1	2	3	4	5	6	7	8	9	10	11	12	13	14	15	16								PLANNED OBSOLESCENCE	SEE 33482-8624			
VOID KEY	33482-1625					1	2	3	4	5	6	7	8	9	10	11	12	13	14	15	16												
KEY A, BLACK	33482-1626	A-BLK	GCP	PLR	M-R	1																15							PLANNED OBSOLESCENCE	SEE 33482-8626			
KEY B, LIGHT GRAY	33482-1627	B-LG	GCP	PLR	M-R	1																16							PLANNED OBSOLESCENCE	SEE 33482-8627			
KEY C, BROWN	33482-1628	C-BR	GCP	PLR	M-R	1																16							PLANNED OBSOLESCENCE	SEE 33482-8628			
KEY D, GREEN	33482-1629	D-GR	GCP	PLR	M-R	1																16							PLANNED OBSOLESCENCE	SEE 33482-8629			
VOID KEY	33482-1630					1																16							PLANNED OBSOLESCENCE	SEE 33482-8630			
KEY A, BLACK	33482-1631					1																16											
KEY A, BLACK	33482-1632	A-BLK	GCP	PLR	M-R								7	8							12	13	14					PLANNED OBSOLESCENCE	SEE 33482-8632				
KEY A, BLACK	33482-1633	A-BLK	GCP	PLR	M-R					3	4	5									10	11	12	13	14	15	16		PLANNED OBSOLESCENCE	SEE 33482-8633			
KEY A, BLACK	33482-1634	A-BLK	GCP	PLR	M-R																	12	13	14					PLANNED OBSOLESCENCE	SEE 33482-8634			
KEY B, LIGHT GRAY	33482-1635	B-LG	GCP	PLR	M-R																	13	14	15	16				PLANNED OBSOLESCENCE	SEE 33482-8635			
KEY A, BLACK	33482-1636	A-BLK	GCP	PLR	M-R																	13	14	15	16				PLANNED OBSOLESCENCE	SEE 33482-8636			
KEY A, BLACK	33482-1637	A-BLK	GCP	PLR	M-R																	10	11						PLANNED OBSOLESCENCE	SEE 33482-8637			
KEY A, BLACK	33482-1638	A-BLK	GCP	PLR	M-R																	8	9						PLANNED OBSOLESCENCE	SEE 33482-8638			
KEY A, BLACK	33482-1639	A-BLK	GCP	PLR	M-R																			15					PLANNED OBSOLESCENCE	SEE 33482-8639			
KEY A, BLACK	33482-1640	A-BLK	GCP	PLR	M-R								5												16				PLANNED OBSOLESCENCE	SEE 33482-8640			
KEY A, BLACK	33482-1641	A-BLK	GCP	PLR	M-R								5																PLANNED OBSOLESCENCE	SEE 33482-8641			
KEY B, LIGHT GRAY	33482-1642	B-LG	GCP	PLR	M-R																	4				14				PLANNED OBSOLESCENCE	SEE 33482-8642		
KEY A, BLACK	33482-1643	A-BLK	GCP	PLR	M-R																				15	16				PLANNED OBSOLESCENCE	SEE 33482-8643		
KEY B, LIGHT GRAY	33482-1644	B-LG	GCP	PLR	M-R																								PLANNED OBSOLESCENCE	SEE 33482-8644			
KEY B, LIGHT GRAY	33482-1645	B-LG	GCP	PLR	M-R																	4							PLANNED OBSOLESCENCE	SEE 33482-8645			
KEY A, BLACK	33482-1646	A-BLK	GCP	PLR	M-R																	4							PLANNED OBSOLESCENCE	SEE 33482-8646			
KEY A, BLACK	33482-1647	A-BLK	GCP	PLR	M-R																					16			PLANNED OBSOLESCENCE	SEE 33482-8647			
KEY A, BLACK	33482-1648	A-BLK	GCP	PLR	M-R																								PLANNED OBSOLESCENCE	SEE 33482-8648			
KEY B, LIGHT GRAY	33482-1649	B-LG	GCP	PLR	M-R																						16		PLANNED OBSOLESCENCE	SEE 33482-8649			
KEY B, LIGHT GRAY	33482-1650	B-LG	GCP	PLR	M-R																	4							PLANNED OBSOLESCENCE	SEE 33482-8650			
KEY B, LIGHT GRAY	33482-1651	B-LG	GCP	PLR	M-R																								PLANNED OBSOLESCENCE	SEE 33482-8651			
KEY B, LIGHT GRAY	33482-1652	B-LG	GCP	PLR	M-R																	6	7	8					PLANNED OBSOLESCENCE	SEE 33482-8652			
KEY A, BLACK	33482-1653	A-BLK	GCP	PLR	M-R																					14			PLANNED OBSOLESCENCE	SEE 33482-8653			
KEY A, BLACK	33482-1654	A-BLK	GCP	PLR	M-R																					15			PLANNED OBSOLESCENCE	SEE 33482-8654			
KEY B, LIGHT GRAY	33482-1655	B-LG	GCP	PLR	M-R																	4							PLANNED OBSOLESCENCE	SEE 33482-8655			
KEY B, LIGHT GRAY	33482-1656	B-LG	GCP	PLR	M-R																	4							PLANNED OBSOLESCENCE	SEE 33482-8656			
KEY A, BLACK	33482-1657	A-BLK	GCP	PLR	M-R																	1							PLANNED OBSOLESCENCE	SEE 33482-8657			
KEY B, LIGHT GRAY	33482-1658	B-LG	GCP	PLR	M-R																								PLANNED OBSOLESCENCE	SEE 33482-8658			
KEY B, LIGHT GRAY	33482-1659	B-LG	GCP	PLR	M-R																	2							PLANNED OBSOLESCENCE	SEE 33482-8659			
KEY B, LIGHT GRAY	33482-1660	B-LG	G																														

MX150 2X8 BLADE SEALED ASSY MAT SEAL
BOM AND PIN OUT SHEET

Table with columns: ASSEMBLY DESCRIPTION, ASSEMBLY PART NUMBER, COMPONENT (HOUSING KEY/COLOR, GROMMET CAP, PLR, MAT SEAL), BLOCKED TERMINALS (1-16), STATUS, COMMENTS, and OPTIONAL ATTACHMENTS SOLD SEPERATELY (BACKSHELL WITH RIBS, BACKSHELL WITHOUT RIBS).

MX150 2X8 BLADE SEALED ASSY MAT SEAL
BOM AND PIN OUT SHEET

ASSEMBLY DESCRIPTION	ASSEMBLY PART NUMBER	COMPONENT				BLOCKED TERMINALS																STATUS	COMMENTS	OPTIONAL ATTACHMENTS SOLD SEPERATELY				
		THE PRESENCE OF AN ABBREVIATION INDICATES THE PRESENCE OF THAT COMPONENT.				CAVITY WITH A NUMBER INDICATES BLOCKED TERMINAL POSITION CAVITY WITHOUT A NUMBER INDICATES OPEN TERMINAL POSITION																		BACKSHELL WITH RIBS	BACKSHELL WITHOUT RIBS			
		HOUSING KEY/COLOR	GROMMET CAP	PLR	MAT SEAL	1	2	3	4	5	6	7	8	9	10	11	12	13	14	15	16							
KEY A, BLACK	33482-8790	A-BLK	GCP	PLR	M-B	1	2			5		7		9		11	12	13	14	15	16	SALEABLE						
KEY A, BLACK	33482-8791	A-BLK	GCP	PLR	M-B	1	2	3															SALEABLE					
KEY A, BLACK	33482-8792	A-BLK	GCP	PLR	M-B					5		7										16	SALEABLE					
KEY A, BLACK	33482-8793	A-BLK	GCP	PLR	M-B		2	3							10	11							SALEABLE					
KEY A, BLACK	33482-8794	A-BLK	GCP	PLR	M-B	1	2	3		5	6						12	13					SALEABLE					
KEY A, BLACK	33482-8795	A-BLK	GCP	PLR	M-B				3						10			13	14	15			SALEABLE					
KEY A, BLACK	33482-8796	A-BLK	GCP	PLR	M-B							7		9					14	15	16		SALEABLE					
KEY A, BLACK	33482-8797	A-BLK	GCP	PLR	M-B							7	8				12						SALEABLE					
KEY A, BLACK	33482-8798	A-BLK	GCP	PLR	M-B			3							10	11	12	13	14	15	16		SALEABLE					
KEY A, BLACK	33482-8799	A-BLK	GCP	PLR	M-B			3	4	5	6	7			10						15	16	SALEABLE					
KEY A, BLACK	33482-8800	A-BLK	GCP	PLR	M-B	1	2			5								13	14				SALEABLE					
KEY A, BLACK	33482-8801	A-BLK	GCP	PLR	M-B					5		7	8	9	10	11	12	13	14				SALEABLE					
KEY A, BLACK	33482-8802	A-BLK	GCP	PLR	M-B					5								13	14				SALEABLE					
KEY A, BLACK	33482-8803	A-BLK	GCP	PLR	M-B	1	2			5													SALEABLE					
KEY A, BLACK	33482-8804	A-BLK	GCP	PLR	M-B	1	2			5		7	8	9	10	11	12	13	14				SALEABLE					
KEY A, BLACK	33482-8805	A-BLK	GCP	PLR	M-B						6				10	11	12	13	14	15	16		SALEABLE					
KEY A, BLACK	33482-8806	A-BLK	GCP	PLR	M-B						6							13	14	15	16		SALEABLE					
KEY A, BLACK	33482-8807	A-BLK	GCP	PLR	M-B						6							13	14				SALEABLE					
KEY A, BLACK	33482-8808	A-BLK	GCP	PLR	M-B	1	2	3	4	5	6							13	14	15	16		SALEABLE					
KEY A, BLACK	33482-8809	A-BLK	GCP	PLR	M-B	1							8								15		SALEABLE					
KEY A, BLACK	33482-8810	A-BLK	GCP	PLR	M-B	1															15		SALEABLE					
KEY A, BLACK	33482-8811	A-BLK	GCP	PLR	M-B								8					13				16	SALEABLE					
KEY A, BLACK	33482-8812	A-BLK	GCP	PLR	M-B								8				11	12	13			16	SALEABLE					
KEY A, BLACK	33482-8813	A-BLK	GCP	PLR	M-B				4	5	6	7			10					14	15	16	SALEABLE					
KEY A, BLACK	33482-8814	A-BLK	GCP	PLR	M-B							7			10								SALEABLE					
KEY A, BLACK	33482-8815	A-BLK	GCP	PLR	M-B	1				3	5	6					12	13					SALEABLE					
KEY A, BLACK	33482-8816	A-BLK	GCP	PLR	M-B				3		5	6	7		10				13	14	15	16	SALEABLE					
KEY A, BLACK	33482-8817	A-BLK	GCP	PLR	M-B											11	12		14	15	16		SALEABLE					
KEY A, BLACK	33482-8818	A-BLK	GCP	PLR	M-B						6	7	8		10	11	12	13	14	15			SALEABLE					
KEY A, BLACK	33482-8819	A-BLK	GCP	PLR	M-B	1	2					7		9	10	11	12	13	14			16	SALEABLE					
KEY A, BLACK	33482-8820	A-BLK	GCP	PLR	M-B							7		9			12	13	14			16	SALEABLE					
KEY A, BLACK	33482-8821	A-BLK	GCP	PLR	M-B		2	3				7		9	10	11					15	16	SALEABLE					
KEY A, BLACK	33482-8822	A-BLK	GCP	PLR	M-B	1			4	5	6		8				12	13	14				SALEABLE					
KEY B, LIGHT GRAY	33482-8823	B-LG	GCP	PLR	M-B					5	6			9			12	13	14	15			SALEABLE					
KEY A, BLACK	33482-8824	A-BLK	GCP	PLR	M-B							7	8										SALEABLE					
KEY A, BLACK	33482-8825	A-BLK	GCP	PLR	M-B										10			13	14	15	16		SALEABLE					
KEY A, BLACK	33482-8826	A-BLK	GCP	PLR	M-B	1	2	3	4	5	6					11	12						SALEABLE					
KEY A, BLACK	33482-8827	A-BLK	GCP	PLR	M-B				3	4		6	7		9							16	SALEABLE					
KEY A, BLACK	33482-8828	A-BLK	GCP	PLR	M-B							6	7		9							16	SALEABLE					
KEY A, BLACK	33482-8829	A-BLK	GCP	PLR	M-B	1	2		4	5		7	8	9							15	16	SALEABLE					
KEY A, BLACK	33482-8830	A-BLK	GCP	PLR	M-B											11	12	13	14	15			SALEABLE					
KEY A, BLACK	33482-8831	A-BLK	GCP	PLR	M-B												12	13	14				SALEABLE					
KEY B, LIGHT GRAY	33482-8832	B-LG	GCP	PLR	M-B													14	15				SALEABLE					
KEY A, BLACK	33482-8833	A-BLK	GCP	PLR	M-B		2						8		10	11					15	16	SALEABLE					
KEY A, BLACK	33482-8834	A-BLK	GCP	PLR	M-B										10	11						15	SALEABLE					
KEY A, BLACK	33482-8835	A-BLK	GCP	PLR	M-B	1							8		10	11						15	SALEABLE					
KEY A, BLACK	33482-8836	A-BLK	GCP	PLR	M-B	1	2	3	4	5	6	7	8		10	11						15	SALEABLE					
KEY A, BLACK	33482-8837	A-BLK	GCP	PLR	M-B	1							8	9	10	11						15	16	SALEABLE				
KEY A, BLACK	33482-8838	A-BLK	GCP	PLR	M-B									9	10	11						15	16	SALEABLE				
KEY A, BLACK	33482-8839	A-BLK	GCP	PLR	M-B	1	2	3	4	5	6	7	8										SALEABLE					

