

TABLE OF CONTENTS	
SHEET NO.	SHEET DESCRIPTION
1	NOTES AND BOM
2	CONFIGURATIONS
3-4	KEY CONFIGURATIONS
5	BLADE SEALED ASSEMBLY
6	SYSTEM PACKAGING
7	BACKSHELL NOTES
8	BACKSHELL
9	BACKSHELL CONFIGURATIONS

NOTES: VALID UNLESS OTHERWISE SPECIFIED

1. GENERAL:

a. APPLICATION SPECIFICATION SEE: AS-33472-100
 -CONTAINS: PRODUCT INTRODUCTION, PRODUCT SUMMARY, CONNECTOR ASSEMBLY, PACKAGING INFORMATION, CONNECTOR MATING, SERVICE INSTRUCTIONS, ELECTRICAL CONTINUITY CHECKING, CRIMPING, AND TROUBLESHOOTING.
 -DESIGNED TO MATE WITH RECEPTACLE SEALED ASSEMBLY AS SPECIFIED IN THE MATING CONNECTOR DRAWINGS CHART.
 +DENOTES DRAWINGS THAT CAN BE ACCESSED AT <http://ewcap.uscarteams.org/>.
 -ASSEMBLY SHIPPED WITH PLR IN PRE-LOCK POSITION (SEE PLR PRE-LOCK VIEW SHEET 5).

b. PRODUCT SPECIFICATION SEE:
 -STANDARD CONFIGURATION: PS-33472-000
 -UL V0 CONFIGURATION: TBD
 CONTAINS: PRODUCT INTRODUCTION, PRODUCT SUMMARY, RATINGS (CURRENT, TEMPERATURE, SEALING, AND FLAMMABILITY), TERMINALS, WIRE DIAMETER RANGE, PRODUCT VALIDATION, AND PRODUCT DEVIATIONS.

c. PACKAGING SPECIFICATION PER MOLEX DRAWING: PK-31300-635

d. PARTS MUST BE IN COMPLIANCE TO MOLEX CHEMICAL SUBSTANCES FOR PRODUCTS AND PACKAGING SPECIFICATION: QEHS-699000-300

e. DATA MUST BE SUBMITTED UNDER THE MOLEX PART NUMBER TO IMS (COMPANY ID#13255)

2. DESIGN - MATERIALS:

a. FOR BILL OF MATERIALS SEE:
 -STANDARD CONFIGURATION: SD-33482-0002
 -UL V0 CONFIGURATION: SD-160084-0002

3. DESIGN - GEOMETRY:

a. THE 3-D CAD DATA IS BASIC (WITHOUT TOLERANCE) AND MASTER FOR THIS PART WITH THE EXCEPTION OF UNDERLINED DIMENSIONS. DIMENSIONAL INFORMATION NOT SHOWN ON THIS DRAWING IS DEFINED BY THE DATA FILE AT ITS LATEST REVISION.

b. GEOMETRIC DIMENSIONS AND TOLERANCES PER ASME Y14.5M-2009

c. EDGES AND UNDIMENSIONED DETAILS PER ISO13715

d. CORNERS SHOWN AS SHARP TO BE R 0.2 MAX.

e. LETTERING SHALL BE 0.15 MAX RAISED IN 0.25 MAX RECESS PAD. THIS INCLUDES RECYCLING CODE, CAVITY ID, VENDOR IDENTIFICATION, AND CUSTOMER MATERIAL NUMBER.

f. VISUAL DEFECTS SHALL MEET COSMETIC STANDARD PS-45499-002 (Class B).

g. LASER MARKING:
 1. PART NUMBER
 2. DAY OF THE YEAR
 3. SHIFT
 4. YEAR

FOR ADDITIONAL INFORMATION SEE SECTION 5 UNDER PROCEDURES IN ES-34735-008.

MATING CONNECTOR DRAWINGS	
DESCRIPTION	MOLEX INLINE
2X2	SD-33472-041, SD-33472-0001
2X3	SD-33472-061
2X4	SD-33472-081
2X6	SD-33472-0001
2X8	SD-33472-0001
2X10	SD-33472-201, SD-33472-0001

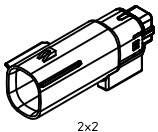

2x2

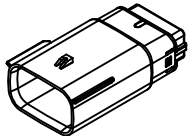

2x6

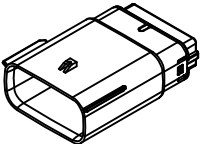

2x8

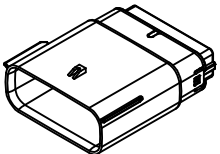

2x10

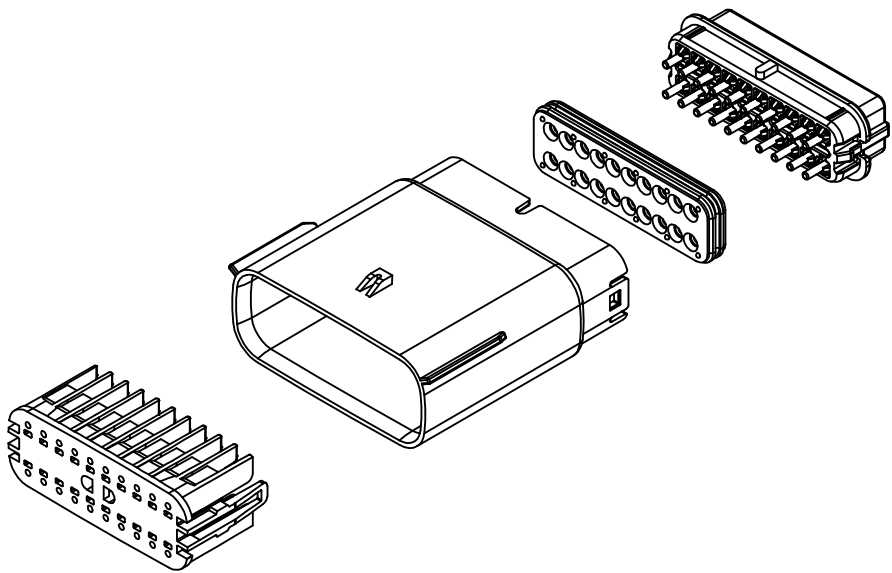

C1	ADD UL V0 CONFIGURATIONS
C	ADD 2X8
B1	ADD 2X6 BACKSHELL INFO
B	ADD 2X6
A	INITIAL RELEASE

INSPECTION NUMBER LOG	ADDED:	REMOVED:
LAST NUMBER: 9		

SCALE	DESIGN UNITS	THIRD ANGLE PROJECTION
1.5:1	METRIC	<input checked="" type="checkbox"/>

ENTER DESCRIPTION IEC NO: UA10205-1759 DRAWN BY: APROFFITT 2015/05/22 CHECKED BY: KBORUSZEWSKI 2015/06/03 APPROVED BY: APPRAVKOSHY 2015/06/04	QUALITY SYMBOLS	GENERAL TOLERANCES (UNLESS SPECIFIED)	DIMENSION STYLE	DRAWN BY	DATE	TITLE
	▽=0	4 PLACES ± --- ± ---	MM ONLY	APROFFITT	2014/04/28	MX150 BLADE DUAL ROW SEALED ASSEMBLY MAT SEAL molex
	▽=0	3 PLACES ± --- ± ---		CHECKED BY	DATE	
	▽=0	2 PLACES ± 0.10 ± ---		KBORUSZEWSKI	2014/04/29	
▽=0	1 PLACE ± 0.2 ± ---		APPROVED BY	DATE		
		0 PLACE ± --- ± ---		VKOSHY	2014/05/14	
		ANGULAR ± 1 °		MATERIAL NO.		DOCUMENT NO.
		DRAFT WHERE APPLICABLE MUST REMAIN WITHIN DIMENSIONS		SEE NOTE 2a.		SD-33482-0001
				SIZE		SHEET NO.
				THIS DRAWING CONTAINS INFORMATION THAT IS PROPRIETARY TO MOLEX INCORPORATED AND SHOULD NOT BE USED WITHOUT WRITTEN PERMISSION		1 OF 9

SHEET DESCRIPTION
CONFIGURATIONS

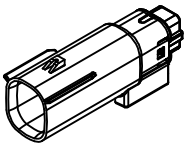

2X2 - STANDARD (STD)

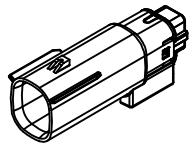

2X2 - UL V0 CONFIGURATION *

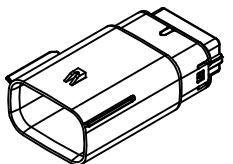

2X6 - STANDARD (STD)

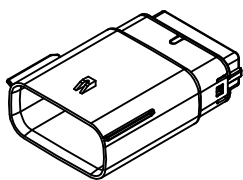

2X8 - STANDARD (STD)

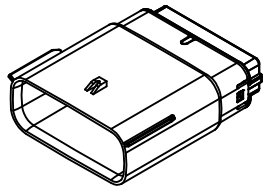

2X10 - STANDARD (STD)

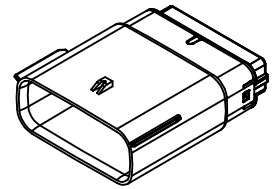

2X10 - UL V0 CONFIGURATION *

* SAME GEOMETRY AS STANDARD CONFIGURATION.
SEE NOTE 2a FOR MORE INFORMATION

ENTER DESCRIPTION EC NO: UAU2015-1759 DRAWN BY: ITT 2015/05/22 CHKD BY: KBORUSZEWSKI 2015/06/03 APPR: VKOSHY 2015/06/04 C1	QUALITY SYMBOLS	GENERAL TOLERANCES (UNLESS SPECIFIED)	DIMENSION STYLE MM ONLY	SCALE 1.5:1	DESIGN UNITS METRIC	THIRD ANGLE PROJECTION
	▽=0	4 PLACES ± --- ± ---	DRAWN BY DATE APPROFF ITT 2014/04/28	TITLE MX150 BLADE DUAL ROW SEALED ASSEMBLY MAT SEAL		
	▽=0.10	3 PLACES ± --- ± ---	CHECKED BY DATE KBORUSZEWSKI 2014/04/29			
	▽=0.2	2 PLACES ± 0.10 ± ---	APPROVED BY DATE VKOSHY 2014/05/14			
▽=0.5	1 PLACE ± 0.2 ± ---	ANGULAR ± 1 °	MATERIAL NO.	DOCUMENT NO.	SHEET NO.	
▽=1	0 PLACE ± --- ± ---	DRAFT WHERE APPLICABLE MUST REMAIN WITHIN DIMENSIONS	SEE NOTE 2a.		2 OF 9	
			THIS DRAWING CONTAINS INFORMATION THAT IS PROPRIETARY TO MOLEX INCORPORATED AND SHOULD NOT BE USED WITHOUT WRITTEN PERMISSION			

SHEET DESCRIPTION
KEY CONFIGURATIONS

2X2

2X3 (SEE E-33482-061)

2X4 (SEE E-33482-061)

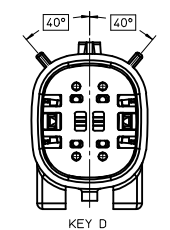
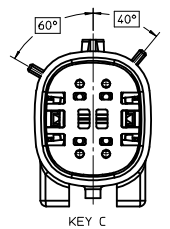
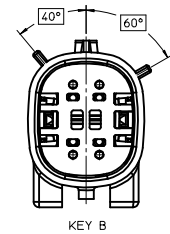
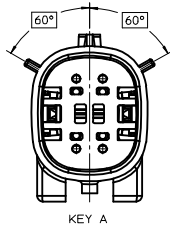

ENTER DESCRIPTION EC NO: UA12015-1759 DRWN: APROFF ITT 2015/05/22 CHKD: KBORUSZEWSKI 2015/06/03 APPR: VKOSHY 2015/06/04	QUALITY SYMBOLS ▽=0 ▽=0 ▽=0	GENERAL TOLERANCES (UNLESS SPECIFIED)		DIMENSION STYLE MM ONLY		SCALE 3:1	DESIGN UNITS METRIC	THIRD ANGLE PROJECTION
		4 PLACES ± --- ± --- 3 PLACES ± --- ± --- 2 PLACES ± 0.10 ± --- 1 PLACE ± 0.2 ± --- 0 PLACE ± --- ± ---	mm INCH ± --- ± --- ± 0.10 ± --- ± 0.2 ± --- ± --- ± ---	DRAWN BY APROFF ITT	DATE 2014/04/28	CHECKED BY KBORUSZEWSKI	DATE 2014/04/29	TITLE MX150 BLADE DUAL ROW SEALED ASSEMBLY MAT SEAL
REV C1	DESCRIPTION DRAFT WHERE APPLICABLE MUST REMAIN WITHIN DIMENSIONS	ANGULAR ± 1 °	MATERIAL NO. SEE NOTE 2a.	APPROVED BY VKOSHY	DATE 2014/05/14	DOCUMENT NO. SD-33482-0001	SHEET NO. 3 OF 9	THIS DRAWING CONTAINS INFORMATION THAT IS PROPRIETARY TO MOLEX INCORPORATED AND SHOULD NOT BE USED WITHOUT WRITTEN PERMISSION

SHEET DESCRIPTION
KEY CONFIGURATIONS CONT.

2X6

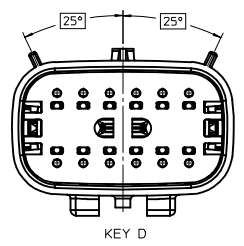
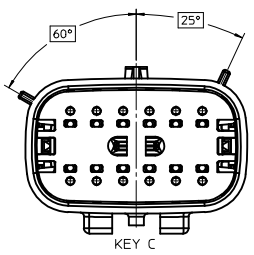
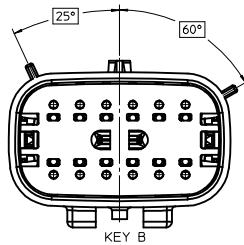
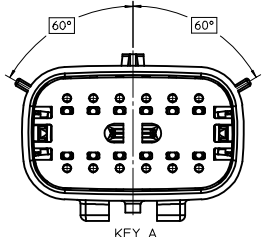

2X8

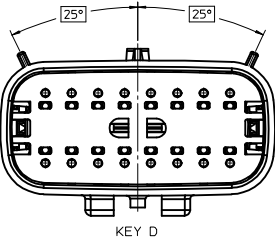
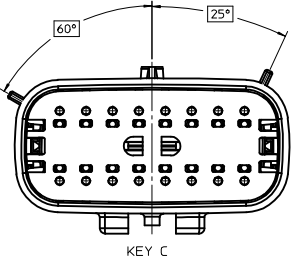
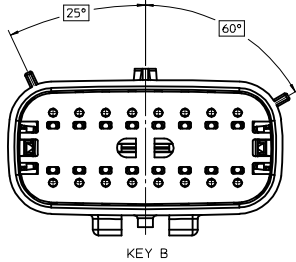
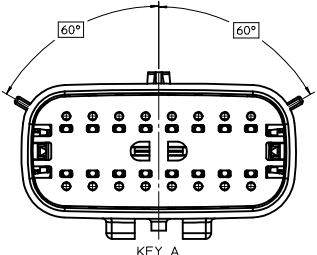

2X10

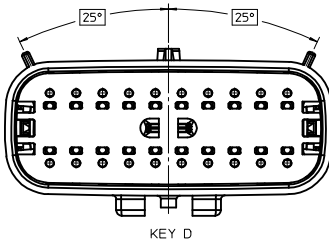
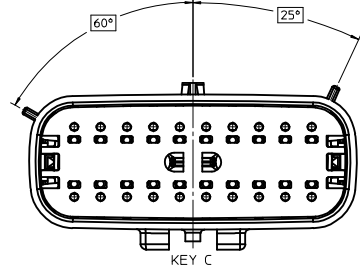
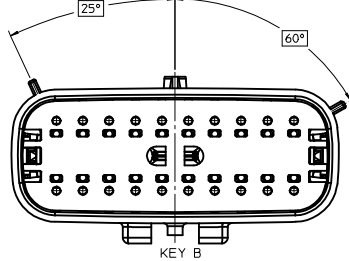
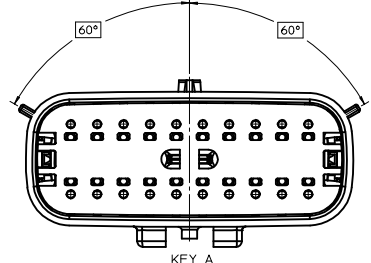

ENTER DESCRIPTION EC NO: UA02015-1759 DRAWN BY: PROFFITT 2015/05/22 CHKD BY: KBORUSZEWSKI 2015/06/03 APPR: WKOSHY 2015/06/04	QUALITY SYMBOLS ∇=0 ∇=0 ∇=0	GENERAL TOLERANCES (UNLESS SPECIFIED)		DIMENSION STYLE MM ONLY	SCALE 3:1	DESIGN UNITS METRIC	THIRD ANGLE PROJECTION		
		4 PLACES ± --- ± ---	3 PLACES ± --- ± ---	2 PLACES ± 0.10 ± ---	1 PLACE ± 0.2 ± ---	0 PLACE ± --- ± ---	DRAWN BY DATE APPROFFITT 2014/04/28		TITLE MX150 BLADE DUAL ROW SEALED ASSEMBLY MAT SEAL
		ANGULAR ± 1 °		DRAFT WHERE APPLICABLE MUST REMAIN WITHIN DIMENSIONS		APPROVED BY DATE KBORUSZEWSKI 2014/04/29		MATERIAL NO. WKOSHY 2014/05/14	
		SEE NOTE 2a.		DOCUMENT NO. SD-33482-0001		SHEET NO. 4 OF 9			

SHEET DESCRIPTION

BLADE SEALED ASSEMBLY

CHARTED DIMENSIONS

DESCRIPTION	DIMENSIONS				
	A	B	C	D	E
2X2	15.54	1.75	24.40	54.45	22.23
2X6	29.54	1.75	32.27	54.45	22.23
2X8	36.54	1.75	38.88	54.45	22.23
2X10	43.64	1.75	45.65	54.45	22.05

OPTIONAL LASER MARKING ON THIS SURFACE SEE NOTE 3g.

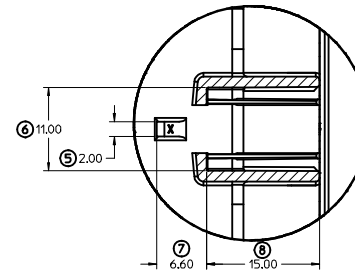
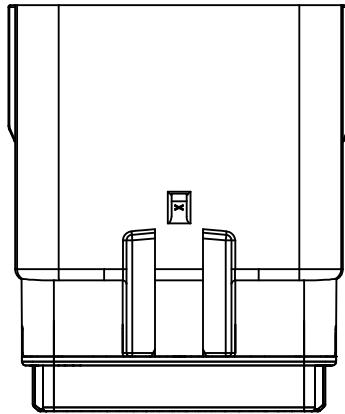
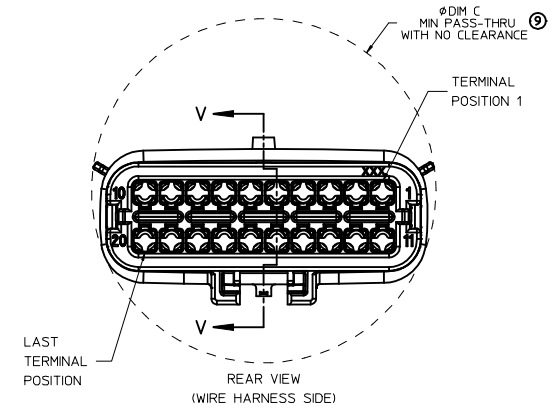
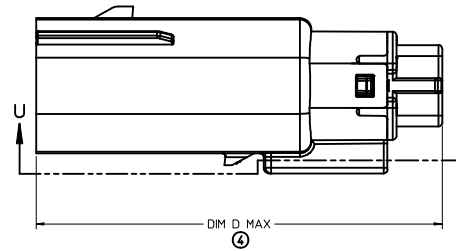
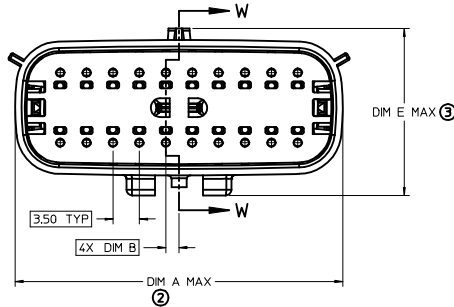
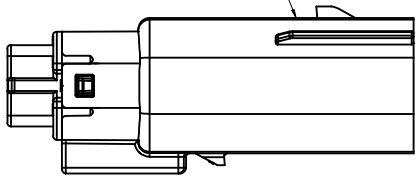

Partial U-U
SCALE 3:1

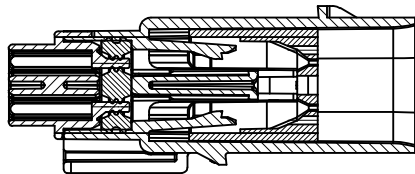

PRIMARY LOCK REINFORCEMENT (PLR) SHOWN
IN PRE-STAGED POSITION
SECTION W-W

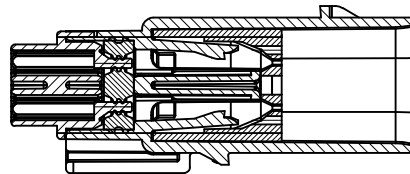

PRIMARY LOCK REINFORCEMENT (PLR) SHOWN
IN FINAL-LOCK POSITION
SECTION V-V

ENTER DESCRIPTION IEC NO: UAU2015-0759 DRAWN BY: ITT CHKD BY: KBORUSZEWSKI APPR: VKOSHY	QUALITY SYMBOLS ∇=0 ∇=0 ∇=0	GENERAL TOLERANCES (UNLESS SPECIFIED)		DIMENSION STYLE MM ONLY		SCALE 3:1	DESIGN UNITS METRIC	THIRD ANGLE PROJECTION	
		4 PLACES ± --- ± ---	3 PLACES ± --- ± ---	2 PLACES ± 0.10 ± ---	1 PLACE ± 0.2 ± ---	0 PLACE ± --- ± ---	DRAWN BY DATE APPROFF ITT 2014/04/28	CHECKED BY DATE KBORUSZEWSKI 2014/04/29	APPROVED BY DATE VKOSHY 2014/05/14
		ANGULAR ± 1 °					MATERIAL NO. SEE NOTE 2a.	DOCUMENT NO. SD-33482-0001	SHEET NO. 5 OF 9
		DRAFT WHERE APPLICABLE MUST REMAIN WITHIN DIMENSIONS					THIS DRAWING CONTAINS INFORMATION THAT IS PROPRIETARY TO MOLEX INCORPORATED AND SHOULD NOT BE USED WITHOUT WRITTEN PERMISSION		

molex

MX150 BLADE
DUAL ROW SEALED ASSEMBLY
MAT SEAL

SHEET DESCRIPTION

SYSTEM PACKAGING

CHARTED DIMENSIONS

CKT	BLADE CONFIGURATION	RECEPTACLE CONFIGURATION	DIMENSIONS	
			K	L
2X2	STANDARD	STANDARD	72.78	28.00
		LENGTHENED	77.21	
2X6	STANDARD	STANDARD	72.79	35.58
2X8	STANDARD	STANDARD	72.67	42.25
2X10	STANDARD	STANDARD	72.78	49.05

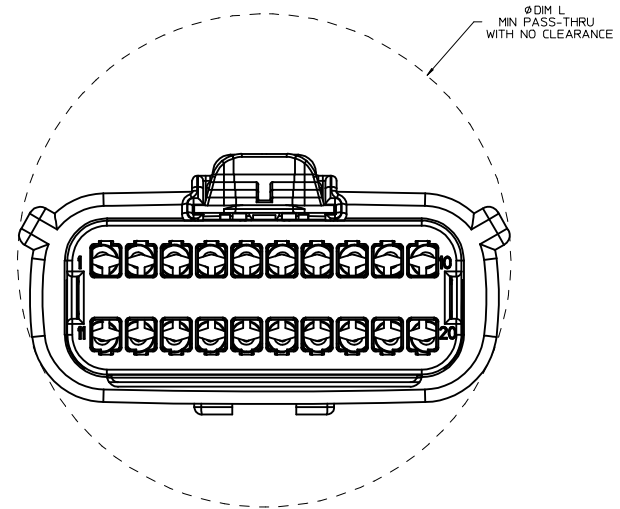
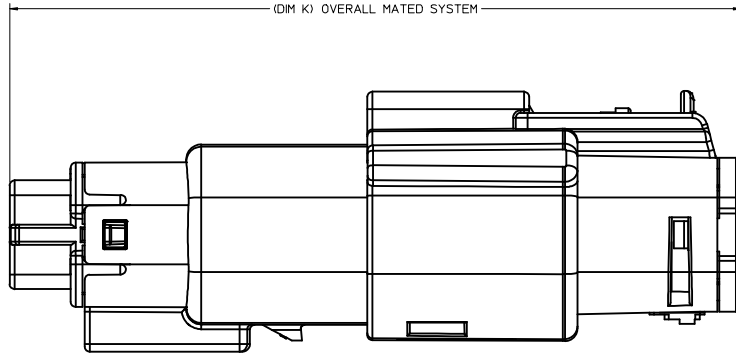

ENTER DESCRIPTION EC NO: UA02015-1759 DRAWN BY: APROFFITT 2015/05/22 CHKD BY: KBORUSZEWSKI 2015/06/03 APPR BY: VKOSHY 2015/06/04	QUALITY SYMBOLS ∇=0 ∇=0 ∇=0	GENERAL TOLERANCES (UNLESS SPECIFIED)		DIMENSION STYLE MM ONLY	SCALE 4:1	DESIGN UNITS METRIC	THIRD ANGLE PROJECTION		
		4 PLACES ± --- ± --- 3 PLACES ± --- ± --- 2 PLACES ± 0.10 ± --- 1 PLACE ± 0.2 ± --- 0 PLACE ± --- ± ---	mm INCH	DRAWN BY DATE APROFFITT 2014/04/28	CHECKED BY DATE KBORUSZEWSKI 2014/04/29	APPROVED BY DATE VKOSHY 2014/05/14	TITLE MX150 BLADE DUAL ROW SEALED ASSEMBLY MAT SEAL		
		ANGULAR ± 1 ° DRAFT WHERE APPLICABLE MUST REMAIN WITHIN DIMENSIONS		MATERIAL NO. SEE NOTE 2a.	DOCUMENT NO. SD-33482-0001	SHEET NO. 6 OF 9			
		THIS DRAWING CONTAINS INFORMATION THAT IS PROPRIETARY TO MOLEX INCORPORATED AND SHOULD NOT BE USED WITHOUT WRITTEN PERMISSION							

SHEET DESCRIPTION
BACKSHELL NOTES

BACKSHELL NOTES: VALID UNLESS OTHERWISE SPECIFIED

1. GENERAL:
 a. APPLICATION SPECIFICATION SEE: AS-34951-001
 -DESIGNED TO MATE WITH BLADE SEALED ASSEMBLY SPECIFIED IN MOLEX DRAWING SD-33482-0001.
 -SYSTEM TO BE USED WITH WIRE WITHIN DIAMETER RANGE OF 1.2mm TO 2.69mm.
 -COMPONENTS ARE OPTIONAL AND MUST BE PURCHASED SEPERATELY.
 -BACKSHELL DESIGN IS OWNED BY SCHLEMMER.
 -FOR ADDITIONAL INFORMATION SEE THE BACKSHELL COMPONENT DRAWING SD-34950-0001.

BACKSHELL CUSTOMER MODEL NUMBER LEGEND

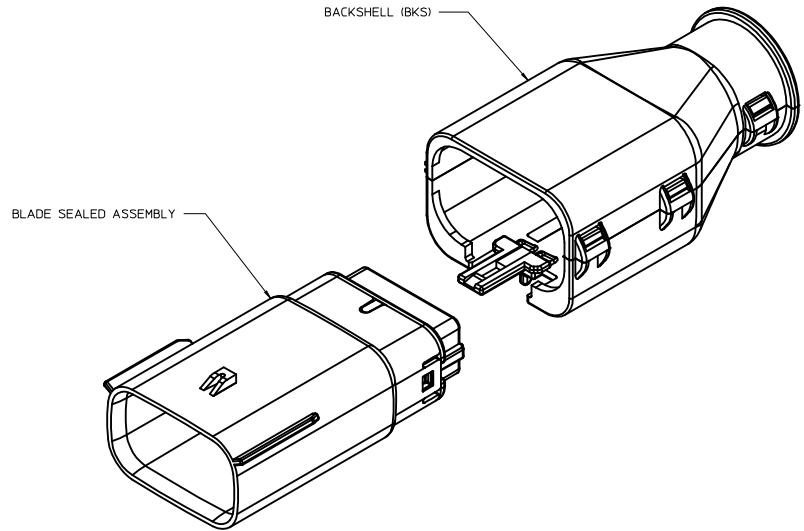
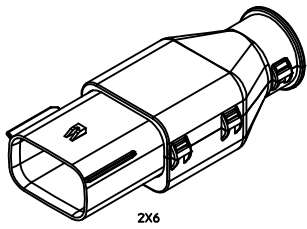
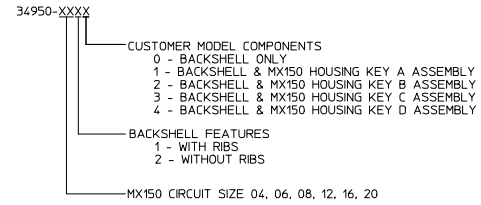

ENTER DESCRIPTION ELEC NO: UAU2015-759 DRAWN BY: PROFFITT 2015/05/22 CHKD BY: KBORUSZEWSKI 2015/06/03 APPR: WKOSHY 2015/06/04	QUALITY SYMBOLS	GENERAL TOLERANCES (UNLESS SPECIFIED)		DIMENSION STYLE MM ONLY		SCALE 4:1	DESIGN UNITS METRIC	THIRD ANGLE PROJECTION
	▽=0	mm	INCH	DRAWN BY	DATE	TITLE		
	▽=0	4 PLACES ± --- ± ---	APPROFFITT	2014/04/28	MX150 BLADE DUAL ROW SEALED ASSEMBLY MAT SEAL			
	▽=0	3 PLACES ± --- ± ---	CHECKED BY	DATE	molex			
▽=0	2 PLACES ± 0.10 ± ---	APPROVED BY	DATE	MATERIAL NO.		DOCUMENT NO.	SHEET NO.	
▽=0	1 PLACE ± 0.2 ± ---	WKOSHY	2014/05/14	SEE NOTE 2a.		SD-33482-0001	7 OF 9	
▽=0	0 PLACE ± --- ± ---	DRAFT WHERE APPLICABLE MUST REMAIN WITHIN DIMENSIONS		THIS DRAWING CONTAINS INFORMATION THAT IS PROPRIETARY TO MOLEX INCORPORATED AND SHOULD NOT BE USED WITHOUT WRITTEN PERMISSION				

SHEET DESCRIPTION

BACKSHELL

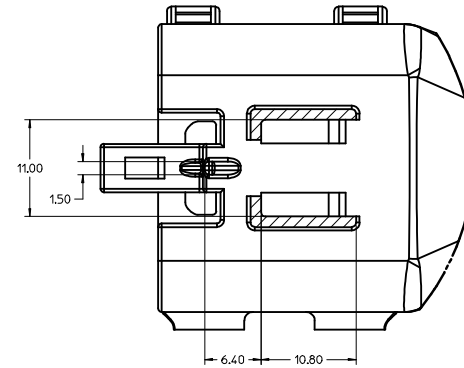
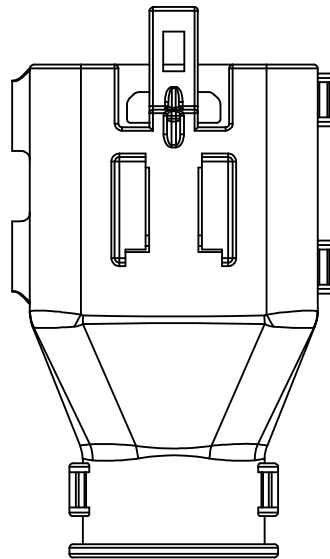
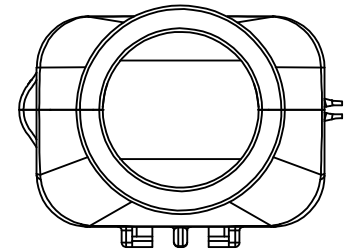
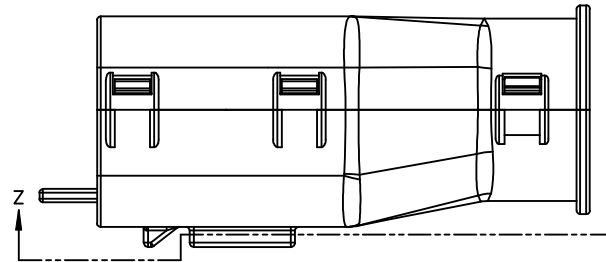
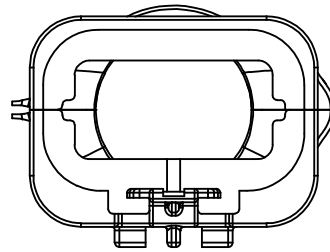
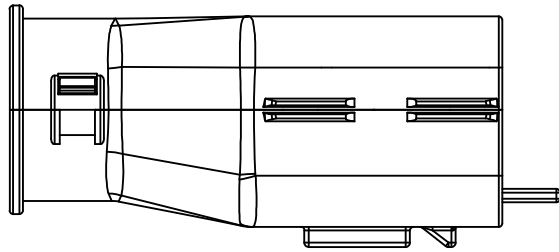

Partial Z-Z
SCALE 35:1

ENTER DESCRIPTION EC NO: UA02015-1759 DRAWN BY: ITT 2015/05/22 CHK: KBORUSZEWSK 2015/06/03 APPR: WKOSHY 2015/06/04	QUALITY SYMBOLS ∇=0 ∇=0 ∇=0	GENERAL TOLERANCES (UNLESS SPECIFIED)		DIMENSION STYLE MM ONLY	SCALE 3.5:1	DESIGN UNITS METRIC	THIRD ANGLE PROJECTION
		4 PLACES ± --- ± ---	mm INCH	DRAWN BY DATE APPROFFITT 2014/04/28	TITLE MX150 BLADE DUAL ROW SEALED ASSEMBLY MAT SEAL		
		3 PLACES ± --- ± ---	2 PLACES ± 0.10 ± ---	CHECKED BY DATE KBORUSZEWSK 2014/04/29	MATERIAL NO. SEE NOTE 2a.		
		1 PLACE ± 0.2 ± ---	0 PLACE ± --- ± ---	APPROVED BY DATE WKOSHY 2014/05/14	DOCUMENT NO. SD-33482-0001	SHEET NO. 8 OF 9	
DRAFT WHERE APPLICABLE MUST REMAIN WITHIN DIMENSIONS		THIS DRAWING CONTAINS INFORMATION THAT IS PROPRIETARY TO MOLEX INCORPORATED AND SHOULD NOT BE USED WITHOUT WRITTEN PERMISSION					

SHEET DESCRIPTION
BACKSHELL CONFIGURATIONS

CHARTED DIMENSIONS							
CKT	BLADE CONFIGURATION	RECEPTACLE CONFIGURATION	DIMENSIONS				
			M	N	P	R	S
2X6	STANDARD	STANDARD	106.83	37.84	37.27	35.83	36.83

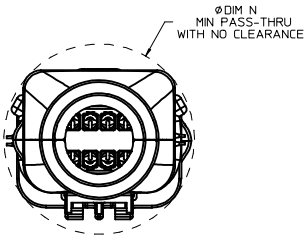
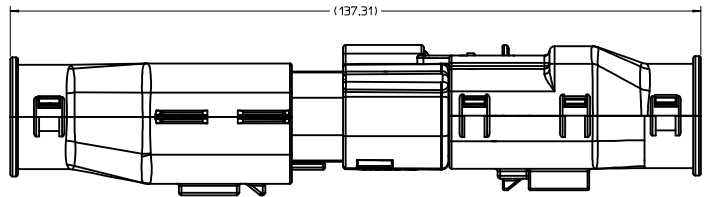

OVERALL MATED SYSTEM WITH BLADE AND RECEPTACLE BACKSHELL

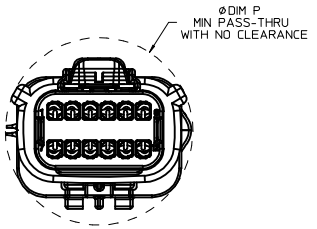
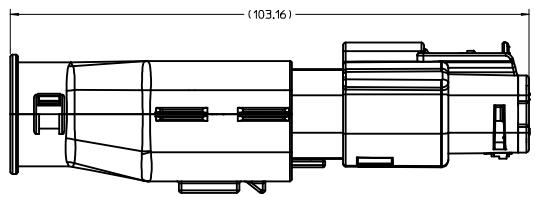

OVERALL MATED SYSTEM WITH BLADE BACKSHELL

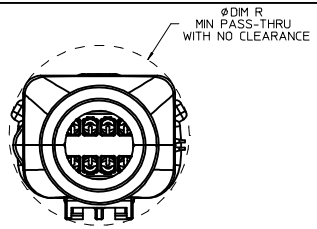
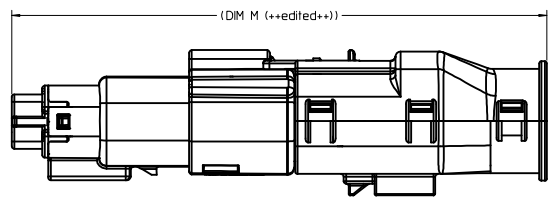

OVERALL MATED SYSTEM WITH RECEPTACLE BACKSHELL

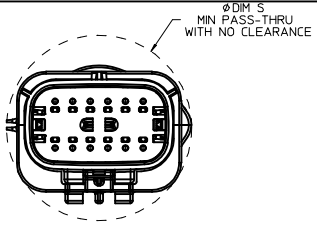
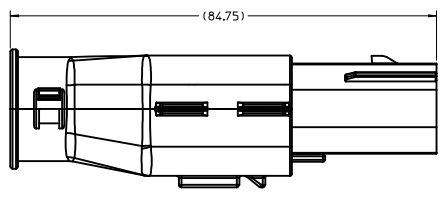

BLADE SEALED ASSEMBLY WITH BLADE BACKSHELL

ENTER DESCRIPTION EC NO: UAU2015-1759 DRAWN BY: APROFFITT 2015/05/22 CHKD BY: KBORUSZEWSKI 2015/06/03 APPR BY: VKOSHY 2015/06/04	QUALITY SYMBOLS ∇=0 ∇=0 ∇=0 ∇=0	GENERAL TOLERANCES (UNLESS SPECIFIED) mm INCH 4 PLACES ± --- ± --- 3 PLACES ± --- ± --- 2 PLACES ± 0.10 ± --- 1 PLACE ± 0.2 ± --- 0 PLACE ± --- ± --- ANGULAR ± 1 ° DRAFT WHERE APPLICABLE MUST REMAIN WITHIN DIMENSIONS	DIMENSION STYLE MM ONLY DRAWN BY: APROFFITT 2014/04/28 CHECKED BY: KBORUSZEWSKI 2014/04/29 APPROVED BY: VKOSHY 2014/05/14	SCALE: 2:1 DESIGN UNITS: METRIC THIRD ANGLE PROJECTION	TITLE: MX150 BLADE DUAL ROW SEALED ASSEMBLY MAT SEAL molex DOCUMENT NO: SD-33482-0001	SHEET NO: 9 OF 9	
							SEE NOTE 2a.
							THIS DRAWING CONTAINS INFORMATION THAT IS PROPRIETARY TO MOLEX INCORPORATED AND SHOULD NOT BE USED WITHOUT WRITTEN PERMISSION
							SIZE: 1

MX150 2X6 BLADE SEALED ASSY MAT SEAL
BOM AND PIN OUT SHEET

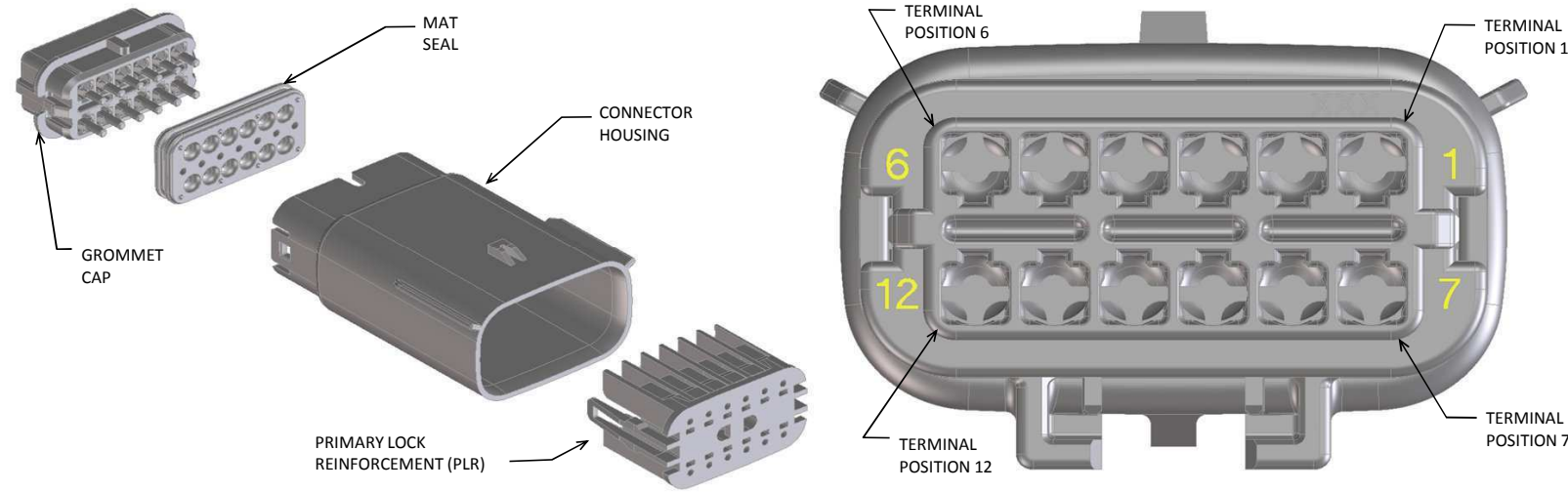

ABBREVIATION	DESCRIPTION	COLOR	MATERIAL
A-BLK	HOUSING, KEYING OPTION A	BLACK	SPS/NYLON GF20
B-LG	HOUSING, KEYING OPTION B	LIGHT GRAY	SPS/NYLON GF20
C-BR	HOUSING, KEYING OPTION C	BROWN	SPS/NYLON GF20
D-GR	HOUSING, KEYING OPTION D	GREEN	SPS/NYLON GF20
A-YL	HOUSING, KEYING OPTION A	YELLOW	SPS/NYLON GF20
C-DG	HOUSING, KEYING OPTION C	DARK GRAY	SPS/NYLON GF20
D-SG	HOUSING, KEYING OPTION D	STONE GRAY	SPS/NYLON GF20
GCP	GROMMET CAP (PLUGGED)	BLACK	SPS/NYLON GF20
PLR	PLR	NATURAL	SPS/NYLON GF20
M	MAT SEAL	RUST RED	INHERENTLY LUBRICATED SILICONE

FOR ADDITIONAL INFORMATION SEE SD-33482-0001

ASSEMBLY DESCRIPTION	ASSEMBLY PART NUMBER	COMPONENT				BLOCKED TERMINALS												STATUS	COMMENTS	OPTIONAL ATTACHMENTS SOLD SEPERATELY		
		HOUSING KEY/COLOR	GROMMET CAP	PLR	MAT SEAL	CAVITY WITH A NUMBER INDICATES BLOCKED TERMINAL POSITION CAVITY WITHOUT A NUMBER INDICATES OPEN TERMINAL POSITION														BACKSHELL WITH RIBS	BACKSHELL WITHOUT RIBS	
						1	2	3	4	5	6	7	8	9	10	11	12					
KEY A, BLACK	33482-1201	A-BLK	GCP	PLR	M														SALEABLE		34950-1210	34950-1220
KEY B, LIGHT GRAY	33482-1202	B-LG	GCP	PLR	M														SALEABLE		34950-1210	34950-1220
KEY C, BROWN	33482-1203	C-BR	GCP	PLR	M														NOT RECOMMENDED	SEE 33482-1261	34950-1210	34950-1220
KEY D, GREEN	33482-1204	D-GR	GCP	PLR	M														NOT RECOMMENDED	SEE 33482-1262	34950-1210	34950-1220
VOID KEY	33482-1205																					
KEY A, BLACK	33482-1206	A-BLK	GCP	PLR	M						6								SALEABLE		34950-1210	34950-1220
KEY B, LIGHT GRAY	33482-1207	B-LG	GCP	PLR	M						6								SALEABLE		34950-1210	34950-1220
KEY C, BROWN	33482-1208	C-BR	GCP	PLR	M						6								NOT RECOMMENDED		34950-1210	34950-1220
KEY D, GREEN	33482-1209	D-GR	GCP	PLR	M						6								NOT RECOMMENDED		34950-1210	34950-1220
VOID KEY	33482-1210																					
KEY A, BLACK	33482-1211	A-BLK	GCP	PLR	M						6	7							SALEABLE		34950-1210	34950-1220
KEY B, LIGHT GRAY	33482-1212	B-LG	GCP	PLR	M						6	7							SALEABLE		34950-1210	34950-1220
KEY C, BROWN	33482-1213	C-BR	GCP	PLR	M						6	7							NOT RECOMMENDED		34950-1210	34950-1220
KEY D, GREEN	33482-1214	D-GR	GCP	PLR	M						6	7							NOT RECOMMENDED		34950-1210	34950-1220
VOID KEY	33482-1215																					
KEY A, BLACK	33482-1216	A-BLK	GCP	PLR	M	1					6	7							SALEABLE		34950-1210	34950-1220
KEY B, LIGHT GRAY	33482-1217	B-LG	GCP	PLR	M	1					6	7							SALEABLE		34950-1210	34950-1220
KEY C, BROWN	33482-1218	C-BR	GCP	PLR	M	1					6	7							NOT RECOMMENDED	SEE 33482-1320	34950-1210	34950-1220
KEY D, GREEN	33482-1219	D-GR	GCP	PLR	M	1					6	7							NOT RECOMMENDED	SEE 33482-1285	34950-1210	34950-1220
VOID KEY	33482-1220																					
KEY A, BLACK	33482-1221	A-BLK	GCP	PLR	M	1					6	7						12	SALEABLE		34950-1210	34950-1220
KEY B, LIGHT GRAY	33482-1222	B-LG	GCP	PLR	M	1					6	7						12	SALEABLE		34950-1210	34950-1220
KEY C, BROWN	33482-1223	C-BR	GCP	PLR	M	1					6	7						12	NOT RECOMMENDED		34950-1210	34950-1220
KEY D, GREEN	33482-1224	D-GR	GCP	PLR	M	1					6	7						12	NOT RECOMMENDED		34950-1210	34950-1220
VOID KEY	33482-1225																					
KEY A, BLACK	33482-1226	A-BLK	GCP	PLR	M						6							12	SALEABLE		34950-1210	34950-1220
KEY A, BLACK	33482-1227	A-BLK	GCP	PLR	M	1	2	3	4	5	6	7	8	9	10	11	12		SALEABLE		34950-1210	34950-1220
KEY B, LIGHT GRAY	33482-1228	B-LG	GCP	PLR	M	1	2	3	4	5	6	7	8	9	10	11	12		SALEABLE		34950-1210	34950-1220
KEY C, BROWN	33482-1229	C-BR	GCP	PLR	M	1	2	3	4	5	6	7	8	9	10	11	12		NOT RECOMMENDED	SEE 33482-1263	34950-1210	34950-1220
KEY D, GREEN	33482-1230	D-GR	GCP	PLR	M	1	2	3	4	5	6	7	8	9	10	11	12		NOT RECOMMENDED	SEE 33482-1264	34950-1210	34950-1220
VOID KEY	33482-1231																					
KEY A, BLACK	33482-1232	A-BLK	GCP	PLR	M		2	3					8				11		SALEABLE		34950-1210	34950-1220
KEY A, BLACK	33482-1233	A-BLK	GCP	PLR	M		2	3			5	6	7	8			11		SALEABLE		34950-1210	34950-1220
KEY A, BLACK	33482-1234	A-BLK	GCP	PLR	M						6	7	7	8					SALEABLE		34950-1210	34950-1220
KEY A, BLACK	33482-1235	A-BLK	GCP	PLR	M		2	3			6	7	8		10	11			SALEABLE		34950-1210	34950-1220
KEY B, LIGHT GRAY	33482-1236	B-LG	GCP	PLR	M	1					5	6	7	8	9	10			SALEABLE		34950-1210	34950-1220
KEY A, BLACK	33482-1237	A-BLK	GCP	PLR	M			2											SALEABLE		34950-1210	34950-1220
KEY B, LIGHT GRAY	33482-1238	B-LG	GCP	PLR	M		2								9	10			SALEABLE		34950-1210	34950-1220
KEY A, BLACK	33482-1239	A-BLK	GCP	PLR	M	1					5	6	7	8					SALEABLE		34950-1210	34950-1220
KEY A, BLACK	33482-1240	A-BLK	GCP	PLR	M		2	3					8	9	10	11			SALEABLE		34950-1210	34950-1220
KEY A, BLACK	33482-1241	A-BLK	GCP	PLR	M								7	8	9	10	11		SALEABLE		34950-1210	34950-1220
KEY A, BLACK	33482-1242	A-BLK	GCP	PLR	M								7	8					SALEABLE		34950-1210	34950-1220
KEY A, BLACK	33482-1243	A-BLK	GCP	PLR	M		2							9	10				SALEABLE		34950-1210	34950-1220
KEY A, BLACK	33482-1244	A-BLK	GCP	PLR	M		2		4										SALEABLE		34950-1210	34950-1220
KEY A, BLACK	33482-1245	A-BLK	GCP	PLR	M										9	10	11	12	SALEABLE		34950-1210	34950-1220
KEY A, BLACK	33482-1246	A-BLK	GCP	PLR	M												11		SALEABLE		34950-1210	34950-1220
KEY A, BLACK	33482-1247	A-BLK	GCP	PLR	M		2	3	4				7	8					SALEABLE		34950-1210	34950-1220
KEY A, BLACK	33482-1248	A-BLK	GCP	PLR	M	1		3	4	5	6	7	8						SALEABLE		34950-1210	34950-1220
KEY A, BLACK	33482-1249	A-BLK	GCP	PLR	M										10	11	12		SALEABLE		34950-1210	34950-1220
KEY A, BLACK	33482-1250	A-BLK	GCP	PLR	M				4	5	6	7	8	9					SALEABLE		34950-1210	34950-1220

MX150 2X6 BLADE SEALED ASSY MAT SEAL
BOM AND PIN OUT SHEET

ASSEMBLY DESCRIPTION	ASSEMBLY PART NUMBER	COMPONENT				BLOCKED TERMINALS												STATUS	COMMENTS	OPTIONAL ATTACHMENTS SOLD SEPERATELY			
		THE PRESENCE OF AN ABBREVIATION INDICATES THE PRESENCE OF THAT COMPONENT.				CAVITY WITH A NUMBER INDICATES BLOCKED TERMINAL POSITION CAVITY WITHOUT A NUMBER INDICATES OPEN TERMINAL POSITION														BACKSHELL WITH RIBS	BACKSHELL WITHOUT RIBS		
		HOUSING KEY/COLOR	GROMMET CAP	PLR	MAT SEAL	1	2	3	4	5	6	7	8	9	10	11	12						
KEY A, BLACK	33482-1251	A-BLK	GCP	PLR	M		2		4	5			7	8		10	11		SALEABLE		34950-1210	34950-1220	
KEY A, BLACK	33482-1252	A-BLK	GCP	PLR	M								7	8					SALEABLE		34950-1210	34950-1220	
KEY A, BLACK	33482-1253	A-BLK	GCP	PLR	M		2	3	4	5	6	7	8			10	11	12	SALEABLE		34950-1210	34950-1220	
KEY A, BLACK	33482-1254	A-BLK	GCP	PLR	M		2	3	4	5						10	11	12	SALEABLE		34950-1210	34950-1220	
KEY A, BLACK	33482-1255	A-BLK	GCP	PLR	M		2	3	4	5	6	7				10	11	12	SALEABLE		34950-1210	34950-1220	
KEY A, BLACK	33482-1256	A-BLK	GCP	PLR	M	1					6	7		9					SALEABLE		34950-1210	34950-1220	
KEY A, BLACK	33482-1257	A-BLK	GCP	PLR	M									9	10		12		SALEABLE		34950-1210	34950-1220	
KEY A, BLACK	33482-1258	A-BLK	GCP	PLR	M		2	3									11		SALEABLE		34950-1210	34950-1220	
KEY A, BLACK	33482-1259	A-BLK	GCP	PLR	M	1	2	3	4	5				9	10		11	12	SALEABLE		34950-1210	34950-1220	
KEY A, BLACK	33482-1260	A-BLK	GCP	PLR	M												11	12	SALEABLE		34950-1210	34950-1220	
KEY C, DARK GRAY	33482-1261	C-DG	GCP	PLR	M														SALEABLE		34950-1210	34950-1220	
KEY D, STONE GRAY	33482-1262	D-SG	GCP	PLR	M														SALEABLE		34950-1210	34950-1220	
KEY C, DARK GRAY	33482-1263	C-DG	GCP	PLR	M	1	2	3	4	5	6	7	8	9	10		11	12	SALEABLE		34950-1210	34950-1220	
KEY D, STONE GRAY	33482-1264	D-SG	GCP	PLR	M	1	2	3	4	5	6	7	8	9	10		11	12	SALEABLE		34950-1210	34950-1220	
KEY A, BLACK	33482-1265	A-BLK	GCP	PLR	M						6	7	8	9	10		11		SALEABLE		34950-1210	34950-1220	
KEY A, BLACK	33482-1266	A-BLK	GCP	PLR	M	1	2	3	4	5	6	7						12	SALEABLE		34950-1210	34950-1220	
KEY A, BLACK	33482-1267	A-BLK	GCP	PLR	M				3	4	5	6	7						SALEABLE		34950-1210	34950-1220	
KEY A, BLACK	33482-1268	A-BLK	GCP	PLR	M				3	4	5	6	7	8	9	10	11		SALEABLE		34950-1210	34950-1220	
KEY A, BLACK	33482-1269	A-BLK	GCP	PLR	M	1	2	3	4	5				8	9	10	11	12	SALEABLE		34950-1210	34950-1220	
KEY A, BLACK	33482-1270	A-BLK	GCP	PLR	M		2		4				7	8	9	10			SALEABLE		34950-1210	34950-1220	
KEY A, BLACK	33482-1271	A-BLK	GCP	PLR	M		2						7	8	9				SALEABLE		34950-1210	34950-1220	
KEY A, BLACK	33482-1272	A-BLK	GCP	PLR	M		2						7	8	9	10			SALEABLE		34950-1210	34950-1220	
KEY A, BLACK	33482-1273	A-BLK	GCP	PLR	M									8					SALEABLE		34950-1210	34950-1220	
KEY A, BLACK	33482-1274	A-BLK	GCP	PLR	M	1			3	4	5	6				8	10	11	12	SALEABLE		34950-1210	34950-1220
KEY A, BLACK	33482-1275	A-BLK	GCP	PLR	M					4						8	10		SALEABLE		34950-1210	34950-1220	
KEY A, BLACK	33482-1276	A-BLK	GCP	PLR	M	1	2	3	4		6			8		10		11	12	SALEABLE		34950-1210	34950-1220
KEY A, BLACK	33482-1277	A-BLK	GCP	PLR	M	1	2	3									11	12	SALEABLE		34950-1210	34950-1220	
KEY A, BLACK	33482-1278	A-BLK	GCP	PLR	M						6							12	SALEABLE		34950-1210	34950-1220	
KEY A, BLACK	33482-1279	A-BLK	GCP	PLR	M	1	2	3	4	5		7	8	9	10	11			SALEABLE		34950-1210	34950-1220	
KEY A, BLACK	33482-1280	A-BLK	GCP	PLR	M	1	2	3	4	5	6			9					SALEABLE		34950-1210	34950-1220	
KEY A, BLACK	33482-1281	A-BLK	GCP	PLR	M		2		4		6			8		10	11		SALEABLE		34950-1210	34950-1220	
KEY A, BLACK	33482-1282	A-BLK	GCP	PLR	M	1	2	3	4	5	6			9	10	11	12		SALEABLE		34950-1210	34950-1220	
KEY A, BLACK	33482-1283	A-BLK	GCP	PLR	M						6			9	10	11	12		SALEABLE		34950-1210	34950-1220	
KEY A, BLACK	33482-1284	A-BLK	GCP	PLR	M	1			3	4	5	6	7	8		10	11	12	SALEABLE		34950-1210	34950-1220	
KEY D, STONE GRAY	33482-1285	D-SG	GCP	PLR	M	1					6	7							SALEABLE		34950-1210	34950-1220	
KEY A, BLACK	33482-1286	A-BLK	GCP	PLR	M		2	3					8	9					SALEABLE		34950-1210	34950-1220	
KEY A, BLACK	33482-1287	A-BLK	GCP	PLR	M	1							7						SALEABLE		34950-1210	34950-1220	
KEY A, BLACK	33482-1288	A-BLK	GCP	PLR	M	1					6								SALEABLE		34950-1210	34950-1220	
KEY A, BLACK	33482-1289	A-BLK	GCP	PLR	M	1	2	3	4	5	6			8					SALEABLE		34950-1210	34950-1220	
KEY A, BLACK	33482-1290	A-BLK	GCP	PLR	M	1							7					12	SALEABLE		34950-1210	34950-1220	
KEY A, BLACK	33482-1291	A-BLK	GCP	PLR	M	1	2	3	4	5	6	7	8						SALEABLE		34950-1210	34950-1220	
KEY A, BLACK	33482-1292	A-BLK	GCP	PLR	M									9					SALEABLE		34950-1210	34950-1220	
KEY A, BLACK	33482-1293	A-BLK	GCP	PLR	M				3	4				9	10	11	12		SALEABLE		34950-1210	34950-1220	
KEY A, BLACK	33482-1294	A-BLK	GCP	PLR	M	1	2				5	6	7	8					SALEABLE		34950-1210	34950-1220	
KEY A, BLACK	33482-1295	A-BLK	GCP	PLR	M	1	2				5	6	7	8			11	12	SALEABLE		34950-1210	34950-1220	
KEY A, BLACK	33482-1296	A-BLK	GCP	PLR	M	1	2	3	4	5	6	7	8	9	10				SALEABLE		34950-1210	34950-1220	
KEY A, BLACK	33482-1297	A-BLK	GCP	PLR	M				4		6				10	11	12		SALEABLE		34950-1210	34950-1220	
KEY A, BLACK	33482-1298	A-BLK	GCP	PLR	M						6						11	12	SALEABLE		34950-1210	34950-1220	
KEY A, BLACK	33482-1299	A-BLK	GCP	PLR	M	1	2						7	8					SALEABLE		34950-1210	34950-1220	
KEY A, BLACK	33482-1300	A-BLK	GCP	PLR	M	1	2	3						8		10	11	12	SALEABLE		34950-1210	34950-1220	
KEY A, BLACK	33482-1301	A-BLK	GCP	PLR	M	1	2						7	8				12	SALEABLE		34950-1210	34950-1220	
KEY B, LIGHT GRAY	33482-1302	B-LG	GCP	PLR	M										10	11			SALEABLE		34950-1210	34950-1220	
KEY A, BLACK	33482-1303	A-BLK	GCP	PLR	M	1	2	3	4				7	8	9	10		12	SALEABLE		34950-1210	34950-1220	
KEY A, BLACK	33482-1304	A-BLK	GCP	PLR	M	1	2	3	4				7	8	9	10			SALEABLE		34950-1210	34950-1220	
KEY B, LIGHT GRAY	33482-1305	B-LG	GCP	PLR	M										10	11	12		SALEABLE		34950-1210	34950-1220	
KEY B, LIGHT GRAY	33482-1306	B-LG	GCP	PLR	M	1	2	3	4	5	6	7			10	11	12		SALEABLE		34950-1210	34950-1220	
KEY A, BLACK	33482-1307	A-BLK	GCP	PLR	M	1	2	3	4	5			7	8					SALEABLE		34950-1210	34950-1220	
KEY A, BLACK	33482-1308	A-BLK	GCP	PLR	M								7	8	9	10	11	12	SALEABLE		34950-1210	34950-1220	
KEY A, BLACK	33482-1309	A-BLK	GCP	PLR	M	1							8		10	11			SALEABLE		34950-1210	34950-1220	
KEY A, BLACK	33482-1310	A-BLK	GCP	PLR	M	1			4							11			SALEABLE		34950-1210	34950-1220	
KEY A, BLACK	33482-1311	A-BLK	GCP	PLR	M	1	2		4	5	6	7		9	10	11	12		SALEABLE		34950-1210	34950-1220	
KEY A, BLACK	33482-1312	A-BLK	GCP	PLR	M								8	9					SALEABLE		34950-1210	34950-1220	
KEY A, BLACK	33482-1313	A-BLK	GCP	PLR	M				3	4	5	6		8	9	10	11		SALEABLE		34950-1210	34950-1220	
KEY A, BLACK	33482-1314	A-BLK	GCP	PLR	M				3			6	7	8	9	10			SALEABLE		34950-1210	34950-1220	
KEY A, BLACK	33482-1315	A-BLK	GCP	PLR	M						6	7	8	9					SALEABLE		34950-1210	34950-1220	
KEY A, BLACK	33482-1316	A-BLK	GCP	PLR	M					5	6	7	8			11			SALEABLE		34950-1210	34950-1220	
KEY A, BLACK	33482-1317	A-BLK	GCP	PLR	M	1	2												SALEABLE		34950-1210	34950-1220	
KEY A, BLACK	33482-1318	A-BLK	GCP	PLR	M	1	2	3	4	5	6	7	8						SALEABLE		34950-1210	34950-1220	
KEY A, BLACK	33482-1319	A-BLK	GCP	PLR	M	1	2	3	4	5	6	7	8	9					SALEABLE		34950-1210	34950-1220	
KEY C, DARK GRAY	33482-1320	C-DG	GCP	PLR	M	1					6	7							SALEABLE		34950-1210	34950-1220	
KEY C, BROWN	33482-1321	C-BR	GCP	PLR	M	1	2	3	4	5	6								NOT RECOMMENDED	SEE 33482-1328	34950-1210	34950-1220	
KEY C, BROWN	33482-1322	C-BR	GCP	PLR	M	1	2			5	6								NOT RECOMMENDED	SEE 33482-1329	34950-1210	34950-1220	
KEY A, BLACK	33482-1323	A-BLK	GCP	PLR	M				3				7		9	10	11	12	SALEABLE		34950-1210	34950-1220	
KEY A, BLACK	33482-1324	A-BLK	GCP	PLR	M				3						9	10							

MX150 2X6 BLADE SEALED ASSY MAT SEAL
BOM AND PIN OUT SHEET

ASSEMBLY DESCRIPTION	ASSEMBLY PART NUMBER	COMPONENT				BLOCKED TERMINALS												STATUS	COMMENTS	OPTIONAL ATTACHMENTS SOLD SEPERATELY		
		THE PRESENCE OF AN ABBREVIATION INDICATES THE PRESENCE OF THAT COMPONENT.				CAVITY WITH A NUMBER INDICATES BLOCKED TERMINAL POSITION CAVITY WITHOUT A NUMBER INDICATES OPEN TERMINAL POSITION														BACKSHELL WITH RIBS	BACKSHELL WITHOUT RIBS	
		HOUSING KEY/COLOR	GROMMET CAP	PLR	MAT SEAL	1	2	3	4	5	6	7	8	9	10	11	12					
KEY A, BLACK	33482-1325	A-BLK	GCP	PLR	M			3					9					SALEABLE		34950-1210	34950-1220	
KEY A, BLACK	33482-1326	A-BLK	GCP	PLR	M					5	6	7			10	11		SALEABLE		34950-1210	34950-1220	
KEY A, BLACK	33482-1327	A-BLK	GCP	PLR	M							7				11		SALEABLE		34950-1210	34950-1220	
KEY C, DARK GRAY	33482-1328	C-DG	GCP	PLR	M	1	2	3	4	5	6							SALEABLE		34950-1210	34950-1220	
KEY C, DARK GRAY	33482-1329	C-DG	GCP	PLR	M	1	2			5	6							SALEABLE		34950-1210	34950-1220	
KEY A, BLACK	33482-1330	A-BLK	GCP	PLR	M	1	2	3	4					9	10	11	12	SALEABLE		34950-1210	34950-1220	
KEY A, BLACK	33482-1331	A-BLK	GCP	PLR	M	1	2			6	7	8				12		SALEABLE		34950-1210	34950-1220	
KEY A, BLACK	33482-1332	A-BLK	GCP	PLR	M				4	5		7	8	9	10			SALEABLE		34950-1210	34950-1220	
KEY A, BLACK	33482-1333	A-BLK	GCP	PLR	M				4				9	10				SALEABLE		34950-1210	34950-1220	
KEY A, BLACK	33482-1334	A-BLK	GCP	PLR	M				4	5			8		10			SALEABLE		34950-1210	34950-1220	
KEY A, BLACK	33482-1335	A-BLK	GCP	PLR	M	1	2		4	5	6	7					12	SALEABLE		34950-1210	34950-1220	
KEY A, YELLOW	33482-1336	A-YL	GCP	PLR	M													SALEABLE		34950-1210	34950-1220	
KEY B, LIGHT GRAY	33482-1337	B-LG	GCP	PLR	M					5			8					SALEABLE		34950-1210	34950-1220	
KEY B, LIGHT GRAY	33482-1338	B-LG	GCP	PLR	M					5			8			11	12	SALEABLE		34950-1210	34950-1220	
KEY B, LIGHT GRAY	33482-1339	B-LG	GCP	PLR	M			3	4	5			8	9	10	11	12	SALEABLE		34950-1210	34950-1220	
KEY B, LIGHT GRAY	33482-1340	B-LG	GCP	PLR	M	1	2	3	4	5			8	9	10	11	12	SALEABLE		34950-1210	34950-1220	
KEY A, BLACK	33482-1341	A-BLK	GCP	PLR	M	1	2	3		5				9		11		SALEABLE		34950-1210	34950-1220	
KEY A, BLACK	33482-1342	A-BLK	GCP	PLR	M		2	3		5						11		SALEABLE		34950-1210	34950-1220	
KEY A, BLACK	33482-1343	A-BLK	GCP	PLR	M	1	2	3						9				SALEABLE		34950-1210	34950-1220	
KEY A, BLACK	33482-1344	A-BLK	GCP	PLR	M	1	2	3	4	5				9		11	12	SALEABLE		34950-1210	34950-1220	
KEY A, BLACK	33482-1345	A-BLK	GCP	PLR	M		2	3	4	5						11	12	SALEABLE		34950-1210	34950-1220	
KEY A, BLACK	33482-1346	A-BLK	GCP	PLR	M	1												SALEABLE		34950-1210	34950-1220	
KEY A, BLACK	33482-1347	A-BLK	GCP	PLR	M	1	2	3										SALEABLE		34950-1210	34950-1220	
KEY B, LIGHT GRAY	33482-1348	B-LG	GCP	PLR	M	1	2	3	4		6					11	12	SALEABLE		34950-1210	34950-1220	
KEY A, BLACK	33482-1349	A-BLK	GCP	PLR	M				4				7	8				SALEABLE		34950-1210	34950-1220	
KEY A, BLACK	33482-1350	A-BLK	GCP	PLR	M		2						8					SALEABLE		34950-1210	34950-1220	
KEY A, BLACK	33482-1351	A-BLK	GCP	PLR	M		2		4				8		10			SALEABLE		34950-1210	34950-1220	
KEY A, BLACK	33482-1352	A-BLK	GCP	PLR	M	1	2	3	4	5	6		8		10	11	12	SALEABLE		34950-1210	34950-1220	
KEY A, BLACK	33482-1353	A-BLK	GCP	PLR	M	1					6	7	8				12	SALEABLE		34950-1210	34950-1220	
KEY A, BLACK	33482-1354	A-BLK	GCP	PLR	M		2	3	4		6		8		10	11	12	SALEABLE		34950-1210	34950-1220	
KEY A, BLACK	33482-1355	A-BLK	GCP	PLR	M		2				6	7	8		10	11		SALEABLE		34950-1210	34950-1220	
KEY A, BLACK	33482-1356	A-BLK	GCP	PLR	M	1	2	3	4		6				10	11	12	SALEABLE		34950-1210	34950-1220	
KEY A, BLACK	33482-1357	A-BLK	GCP	PLR	M					5			8					SALEABLE		34950-1210	34950-1220	
KEY A, BLACK	33482-1358	A-BLK	GCP	PLR	M				4						10			SALEABLE		34950-1210	34950-1220	
KEY A, BLACK	33482-1359	A-BLK	GCP	PLR	M				4				7	8	9	10	11	12	SALEABLE		34950-1210	34950-1220
KEY A, BLACK	33482-1360	A-BLK	GCP	PLR	M					5	6		8	9	10	11	12	SALEABLE		34950-1210	34950-1220	
KEY A, BLACK	33482-1361	A-BLK	GCP	PLR	M				4	5	6		8	9	10	11	12	SALEABLE		34950-1210	34950-1220	
KEY A, BLACK	33482-1362	A-BLK	GCP	PLR	M	1	2	3		5	6	7	8	9		11	12	SALEABLE		34950-1210	34950-1220	
KEY A, BLACK	33482-1363	A-BLK	GCP	PLR	M				4	5		7	8	9	10	11	12	SALEABLE		34950-1210	34950-1220	
KEY A, BLACK	33482-1364	A-BLK	GCP	PLR	M				4				7	8	9	10		SALEABLE		34950-1210	34950-1220	
KEY A, BLACK	33482-1365	A-BLK	GCP	PLR	M						6	7	8	9	10	11	12	SALEABLE		34950-1210	34950-1220	
KEY A, BLACK	33482-1366	A-BLK	GCP	PLR	M	1	2				6	7				11	12	SALEABLE		34950-1210	34950-1220	
KEY A, BLACK	33482-1367	A-BLK	GCP	PLR	M					5			8		10			SALEABLE		34950-1210	34950-1220	
KEY A, BLACK	33482-1368	A-BLK	GCP	PLR	M	1	2	3	4				7	8	9	10	11	12	SALEABLE		34950-1210	34950-1220
KEY A, BLACK	33482-1369	A-BLK	GCP	PLR	M				4									SALEABLE		34950-1210	34950-1220	
KEY A, BLACK	33482-1370	A-BLK	GCP	PLR	M	1	2	3			6	7			10	11	12	SALEABLE		34950-1210	34950-1220	
KEY A, BLACK	33482-1371	A-BLK	GCP	PLR	M								7	8		11		SALEABLE		34950-1210	34950-1220	
KEY A, BLACK	33482-1372	A-BLK	GCP	PLR	M	1		3		5			8		10		12	SALEABLE		34950-1210	34950-1220	
KEY A, BLACK	33482-1373	A-BLK	GCP	PLR	M		2		4		6	7		9		11		SALEABLE		34950-1210	34950-1220	
KEY A, BLACK	33482-1374	A-BLK	GCP	PLR	M		2								10	11	12	SALEABLE		34950-1210	34950-1220	
KEY A, BLACK	33482-1375	A-BLK	GCP	PLR	M								7		9	10		SALEABLE		34950-1210	34950-1220	
KEY A, BLACK	33482-1376	A-BLK	GCP	PLR	M		2		4				7					SALEABLE		34950-1210	34950-1220	
KEY A, BLACK	33482-1377	A-BLK	GCP	PLR	M	1	2	3	4		6			9	10	11	12	SALEABLE		34950-1210	34950-1220	
KEY A, BLACK	33482-1378	A-BLK	GCP	PLR	M	1		3		5					11	12		SALEABLE		34950-1210	34950-1220	
KEY A, BLACK	33482-1379	A-BLK	GCP	PLR	M	1		3		5			8		10	11	12	SALEABLE		34950-1210	34950-1220	
KEY A, BLACK	33482-1380	A-BLK	GCP	PLR	M		2						7	8				SALEABLE		34950-1210	34950-1220	
KEY A, BLACK	33482-1381	A-BLK	GCP	PLR	M		2		4				7	8				SALEABLE		34950-1210	34950-1220	
KEY A, BLACK	33482-1382	A-BLK	GCP	PLR	M				4	5	6		8		10	11		SALEABLE		34950-1210	34950-1220	
KEY A, BLACK	33482-1383	A-BLK	GCP	PLR	M	1	2	3	4				7	8	9	10	11	SALEABLE		34950-1210	34950-1220	
KEY A, BLACK	33482-1384	A-BLK	GCP	PLR	M			3	4					9	10			SALEABLE		34950-1210	34950-1220	
KEY A, BLACK	33482-1385	A-BLK	GCP	PLR	M			3	4							11	12	SALEABLE		34950-1210	34950-1220	
KEY A, BLACK	33482-1386	A-BLK	GCP	PLR	M	1	2	3	4		6	7	8	9	10	11		SALEABLE		34950-1210	34950-1220	
KEY A, BLACK	33482-1387	A-BLK	GCP	PLR	M	1	2	3	4	5	6	7	8	9			12	SALEABLE		34950-1210	34950-1220	
KEY A, BLACK	33482-1388	A-BLK	GCP	PLR	M	1	2	3						10	11	12		SALEABLE		34950-1210	34950-1220	
KEY A, BLACK	33482-1389	A-BLK	GCP	PLR	M	1	2	3			6				11	12		SALEABLE		34950-1210	34950-1220	
KEY A, BLACK	33482-1390	A-BLK	GCP	PLR	M	1		3	4						11			SALEABLE		34950-1210	34950-1220	
KEY A, BLACK	33482-1391	A-BLK	GCP	PLR	M	1	2	3			6				10	11	12	SALEABLE		34950-1210	34950-1220	
KEY A, BLACK	33482-1392	A-BLK	GCP	PLR	M	1		3	4						11	12		SALEABLE		34950-1210	34950-1220	

MX150 2X8 BLADE SEALED ASSY MAT SEAL
BOM AND PIN OUT SHEET

ASSEMBLY DESCRIPTION	ASSEMBLY PART NUMBER	COMPONENT				BLOCKED TERMINALS																STATUS	COMMENTS	OPTIONAL ATTACHMENTS SOLD SEPERATELY				
		THE PRESENCE OF AN ABBREVIATION INDICATES THE PRESENCE OF THAT COMPONENT.				CAVITY WITH A NUMBER INDICATES BLOCKED TERMINAL POSITION CAVITY WITHOUT A NUMBER INDICATES OPEN TERMINAL POSITION																		BACKSHELL WITH RIBS	BACKSHELL WITHOUT RIBS			
		HOUSING KEY/COLOR	GROMMET CAP	PLR	MAT SEAL	1	2	3	4	5	6	7	8	9	10	11	12	13	14	15	16							
KEY A, BLACK	33482-1749	A-BLK	GCP	PLR	M	1									10	11	12	13	14		16	SALEABLE						
KEY A, BLACK	33482-1750	A-BLK	GCP	PLR	M	1	2							9	10	11	12	13	14		16	SALEABLE						
KEY C, DARK GRAY	33482-1751	C-DG	GCP	PLR	M							8											SALEABLE					
KEY D, STONE GRAY	33482-1752	D-SG	GCP	PLR	M							8											SALEABLE					
KEY C, DARK GRAY	33482-1753	C-DG	GCP	PLR	M							8	9										SALEABLE					
KEY D, STONE GRAY	33482-1754	D-SG	GCP	PLR	M							8	9										SALEABLE					
KEY C, DARK GRAY	33482-1755	C-DG	GCP	PLR	M	1						8	9										SALEABLE					
KEY D, STONE GRAY	33482-1756	D-SG	GCP	PLR	M	1						8	9										SALEABLE					
KEY C, DARK GRAY	33482-1757	C-DG	GCP	PLR	M	1						8	9									16	SALEABLE					
KEY D, STONE GRAY	33482-1758	D-SG	GCP	PLR	M	1						8	9									16	SALEABLE					
KEY A, BLACK	33482-1759	A-BLK	GCP	PLR	M	1	2	3	4	5		8	9	10	11	12	13	14			16	SALEABLE						
KEY A, BLACK	33482-1760	A-BLK	GCP	PLR	M		2						9									16	SALEABLE					
KEY A, BLACK	33482-1761	A-BLK	GCP	PLR	M		2				5		9									16	SALEABLE					
KEY A, BLACK	33482-1762	A-BLK	GCP	PLR	M	1	2				5		7	9	10	11	12	13	14		16	SALEABLE						
KEY A, BLACK	33482-1763	A-BLK	GCP	PLR	M							7										16	SALEABLE					
KEY A, BLACK	33482-1764	A-BLK	GCP	PLR	M						5	6	7		9		11	12	13	14		16	SALEABLE					
KEY A, BLACK	33482-1765	A-BLK	GCP	PLR	M		2				5		7		9		12	13	14		16	SALEABLE						
KEY A, BLACK	33482-1766	A-BLK	GCP	PLR	M						5	6	7		9	10	11	12	13	14		16	SALEABLE					
KEY A, BLACK	33482-1767	A-BLK	GCP	PLR	M						5	6	7		9							16	SALEABLE					
KEY A, BLACK	33482-1768	A-BLK	GCP	PLR	M						5	6	7		9							16	SALEABLE					
KEY A, BLACK	33482-1769	A-BLK	GCP	PLR	M	1			4	5	6		8				12	13	14		16	SALEABLE						
KEY A, BLACK	33482-1770	A-BLK	GCP	PLR	M	1	2		4	5	6		8	9	10		12	13	14	15	16	SALEABLE						
KEY A, BLACK	33482-1771	A-BLK	GCP	PLR	M	1			4		6	7	8		10			13	14	15	16	SALEABLE						
KEY A, BLACK	33482-1772	A-BLK	GCP	PLR	M										10			13	14	15	16	SALEABLE						
KEY A, BLACK	33482-1773	A-BLK	GCP	PLR	M	1	2	3	4	5	6					11	12					SALEABLE						
KEY A, BLACK	33482-1774	A-BLK	GCP	PLR	M										10						15	SALEABLE						
KEY A, BLACK	33482-1775	A-BLK	GCP	PLR	M									9	10						15	16	SALEABLE					
KEY A, BLACK	33482-1776	A-BLK	GCP	PLR	M									9	10						15	16	SALEABLE					
KEY A, YELLOW	33482-1777	A-YW	GCP	PLR	M																	15	16	SALEABLE				
KEY A, BLACK	33482-1778	A-BLK	GCP	PLR	M						5		8										SALEABLE					
KEY A, BLACK	33482-1779	A-BLK	GCP	PLR	M						5	6	7	8	9	10	11	12					SALEABLE					
KEY A, BLACK	33482-1780	A-BLK	GCP	PLR	M				3	4	5	6						13	14				SALEABLE					
KEY A, BLACK	33482-1781	A-BLK	GCP	PLR	M	1			4	5	6	7	8	9	10			13	14	15			SALEABLE					
KEY A, BLACK	33482-1782	A-BLK	GCP	PLR	M	1			4		6	7	8		10	11	12	13	14	15			SALEABLE					
KEY A, BLACK	33482-1783	A-BLK	GCP	PLR	M											11	12				15	SALEABLE						
KEY A, BLACK	33482-1784	A-BLK	GCP	PLR	M				3														SALEABLE					
KEY A, BLACK	33482-1785	A-BLK	GCP	PLR	M	1					5		7			11	12	13	14	15	16	SALEABLE						
KEY A, BLACK	33482-1786	A-BLK	GCP	PLR	M						5		7		9		11	12	13	14	15	16	SALEABLE					
KEY A, BLACK	33482-1787	A-BLK	GCP	PLR	M	1	2				5				9								SALEABLE					
KEY A, BLACK	33482-1788	A-BLK	GCP	PLR	M	1	2						7		9		11	12	13	14	15	16	SALEABLE					
KEY A, BLACK	33482-1789	A-BLK	GCP	PLR	M	1	2				5				9						15		SALEABLE					
KEY A, BLACK	33482-1790	A-BLK	GCP	PLR	M	1	2				5		7		9		11	12	13	14	15	16	SALEABLE					
KEY A, BLACK	33482-1791	A-BLK	GCP	PLR	M	1	2	3															SALEABLE					
KEY A, BLACK	33482-1792	A-BLK	GCP	PLR	M						5		7									16	SALEABLE					
KEY A, BLACK	33482-1793	A-BLK	GCP	PLR	M		2	3							10	11							SALEABLE					
KEY A, BLACK	33482-1794	A-BLK	GCP	PLR	M	1	2	3			5	6						12	13				SALEABLE					
KEY A, BLACK	33482-1795	A-BLK	GCP	PLR	M				3						10			13	14	15			SALEABLE					
KEY A, BLACK	33482-1796	A-BLK	GCP	PLR	M								7		9				14	15	16		SALEABLE					
KEY A, BLACK	33482-1797	A-BLK	GCP	PLR	M								7	8				12					SALEABLE					
KEY A, BLACK	33482-1798	A-BLK	GCP	PLR	M				3						10	11	12	13	14	15	16		SALEABLE					
KEY A, BLACK	33482-1799	A-BLK	GCP	PLR	M				3	4	5	6	7		10						15	16	SALEABLE					
KEY A, BLACK	33482-1800	A-BLK	GCP	PLR	M	1	2				5							13	14				SALEABLE					
KEY A, BLACK	33482-1801	A-BLK	GCP	PLR	M						5		7	8	9	10	11	12	13	14			SALEABLE					
KEY A, BLACK	33482-1802	A-BLK	GCP	PLR	M						5							13	14				SALEABLE					
KEY A, BLACK	33482-1803	A-BLK	GCP	PLR	M	1	2				5												SALEABLE					
KEY A, BLACK	33482-1804	A-BLK	GCP	PLR	M	1	2				5		7	8	9	10	11	12	13	14			SALEABLE					
KEY A, BLACK	33482-1805	A-BLK	GCP	PLR	M							6			10	11	12	13	14	15	16		SALEABLE					
KEY A, BLACK	33482-1806	A-BLK	GCP	PLR	M							6						13	14	15	16		SALEABLE					
KEY A, BLACK	33482-1807	A-BLK	GCP	PLR	M							6						13	14				SALEABLE					
KEY A, BLACK	33482-1808	A-BLK	GCP	PLR	M	1	2	3	4	5	6							13	14	15	16		SALEABLE					
KEY A, BLACK	33482-1809	A-BLK	GCP	PLR	M	1							8								15		SALEABLE					
KEY A, BLACK	33482-1810	A-BLK	GCP	PLR	M	1															15		SALEABLE					
KEY A, BLACK	33482-1811	A-BLK	GCP	PLR	M								8								16		SALEABLE					
KEY A, BLACK	33482-1812	A-BLK	GCP	PLR	M								8			11	12	13				16	SALEABLE					
KEY A, BLACK	33482-1813	A-BLK	GCP	PLR	M				4	5	6	7			10					14	15	16	SALEABLE					
KEY A, BLACK	33482-1814	A-BLK	GCP	PLR	M								7		10								SALEABLE					
KEY A, BLACK	33482-1815	A-BLK	GCP	PLR	M	1			3		5	6						12	13				SALEABLE					
KEY A, BLACK	33482-1816	A-BLK	GCP	PLR	M				3		5	6	7			10				13	14	15	16	SALEABLE				

