

1X2

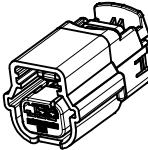

1X3

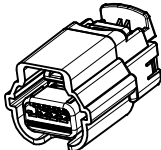

1X4

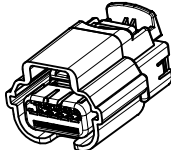

1X5

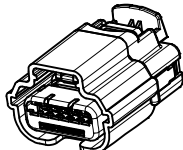

1X6

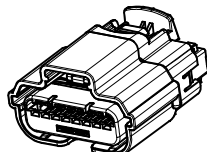

1X8

TABLE OF CONTENTS	
SHEET NO.	SHEET DESCRIPTION
1	NOTES AND BOM
2	CONNECTOR ASSEMBLY WITHOUT CLIPSLOT
3	CONNECTOR ASSEMBLY WITH CLIPSLOT
4-5	KEY CONFIGURATIONS
6-8	BOM

NOTES: VALID UNLESS OTHERWISE SPECIFIED

1. GENERAL:

- a. APPLICATION SPECIFICATION SEE: AS-31402-000
  - CONTAINS: SEE AS CONTENT
  - DESIGNED TO MATE WITH DEVICE OR CONNECTOR AS SPECIFIED IN THE MATING INTERFACE DRAWINGS CHART.
  - \*DENOTES DRAWINGS THAT CAN BE ACCESSED AT <http://ewcap.uscarteams.org/>.
  - ASSEMBLY SHIPPED WITH PLR IN PRE-LOCK POSITION (SEE PLR PRE-LOCK VIEW ON SHEET 2 SECTION A-A).
- b. PRODUCT RELATED DRAWING REFER TO DRAWING INFORMATION CHART
- c. TPA'S MAY BECOME SEATED DURING TRANSIT, IF THIS OCCURS, TPA'S SHOULD BE MOVED TO THE PRE-LOCKED POSITION PRIOR TO FEMALE TERMINAL INSTALLATION. REFERENCE PRODUCT SPECIFICATION: PS-34646-001
- d. PARTS MUST BE IN COMPLIANCE TO MOLEX CHEMICAL SUBSTANCES FOR PRODUCTS AND PACKAGING SPECIFICATION: QEH5-699000-301
- e. DATA MUST BE SUBMITTED UNDER THE MOLEX PART NUMBER TO IMDS (COMPANY ID#13255)
- f. SYSTEM EXCEPT SERIES 31404 1X8 CIRCUIT TO BE USED WITH OUTSIDE WIRE DIAMETERS RANGING FROM 1.20MM TO 2.06MM WITHIN RANGE OF:
  - SAE 22 AWG TO 18 AWG PER ESB-MIL123-A2
  - ISO 0.35MM<sup>2</sup> TO 0.75MM<sup>2</sup> PER GMW15626 AND ES-AU5T-1A348-AA
- g. POLARIZATION FEATURE EFFECTIVENESS PER USCAR-2 PARAGRAPH 5.4.4 IS REDUCED WHEN TESTING ALL POLARIZATION OPTIONS: 100N MIN.
- h. SEE SHEET #3 FOR CONNECTOR ASSEMBLY WITH CLIPSLOT
- i. FOR CLIPSLOT CONNECTOR: CLIP OVERHANGS CONNECTOR, PLEASE CHECK APPLICATION (COULD CAUSE WIRE CHAFING)-SHORTER CLIP IS A RECOMMENDATION.

2. DESIGN - GEOMETRY:

- a. THE 3-D CAD DATA IS BASIC (WITHOUT TOLERANCE) AND MASTER FOR THIS PART WITH THE EXCEPTION OF UNDERLINED DIMENSIONS. DIMENSIONAL INFORMATION NOT SHOWN ON THIS DRAWING IS DEFINED BY THE DATA FILE AT ITS LATEST REVISION.
- b. GEOMETRIC DIMENSIONS AND TOLERANCES PER ASME Y14.5M-2009
- c. EDGES AND UNDIMENSIONED DETAILS PER ISO13715
- d. CORNERS SHOWN AS SHARP TO BE R 0.2 MAX.
- e. LETTERING SHALL BE 0.15 MAX RAISED IN 0.25 MAX RECESS PAD. THIS INCLUDES RECYCLING CODE, CAVITY ID, VENDOR IDENTIFICATION, AND CUSTOMER MATERIAL NUMBER.
- f. VISUAL DEFECTS SHALL MEET COSMETIC STANDARD PS-45499-002 (Class B).
- g. DATE CODE: FIRST TWO DIGITS ARE THE CALENDAR YEAR (EXAMPLE: 04 = 2004). THIRD THROUGH 5TH DIGIT DAY # OF THE CALENDAR YEAR (EXAMPLE: FEB. 3RD = '034').

DRAWING INFORMATION

DESCRIPTION	DRAWING NO.
PRODUCT SPECIFICATION	PS-31402-000 FOR 31404 1X8 REFER TO PS-31404-001-1X8
PACKAGING	PK-31300-256
SALES DRAWING	SD-31402-211
	FOR 31404 1X8 REFER TO SD-31404-811
TEST SUMMARY	FOR 1X2 REFER TO TS-31402-001-1X2
	FOR 1X3 REFER TO TS-31402-001-1X3
	FOR 1X6 REFER TO TS-31402-001-1X6
	FOR 31404 1X8 REFER TO TS-31404-001-1X8

MATING INTERFACE DRAWING

DESCRIPTION	INTERFACE DEFINITION
1X2	*064-S-002-1-Z02
1X3	*064-S-003-1-Z01
1X4	*064-S-004-1-Z02
1X5	*064-S-005-1-Z02
1X6	*064-S-006-1-Z02
1X8	*064-S-008-1-Z02

PART NUMBER LEGEND  
CONNECTOR ASSEMBLY

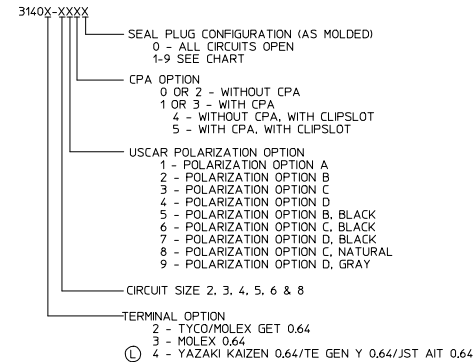

M	ADD P/N: 31402-6118, 31402-6108
L	1. REDRAW SALES DRAWING 2. UPDATE TERMINAL INFORMATION FOR 31404 SERIES 3. ADD P/N: 31403-6212; 31403-6202
REV	REV DESCRIPTION

<b>REDRAW</b> EC NO: UAU2017-0056 DRAWN BY: 2016/07/23 CHKD: 2016/07/26 APPR: IDEN602 REV:	QUALITY SYMBOLS	GENERAL TOLERANCES (UNLESS SPECIFIED)	DIMENSION STYLE	SCALE	DESIGN UNITS	THIRD ANGLE PROJECTION	
	▽=0	mm	MM ONLY	4:1	METRIC	☉	
	▽=0	INCH	4 PLACES ± --- ± ---	DRAWN BY: RCARLSON	DATE: 2003/09/25	TITLE: 0.64 USCAR CONNECTOR SEALED SINGLE ROW ASSEMBLY	
	▽=0	ANGULAR ± 3 °	3 PLACES ± --- ± ---	CHECKED BY: RCARLSON	DATE: 2004/09/28	molex	
		DRAFT WHERE APPLICABLE MUST REMAIN WITHIN DIMENSIONS	MATERIAL NO. SEE CHART	APPROVED BY: VKOSHY	DATE: 2010/11/22	DOCUMENT NO. SD-31402-211	
			SIZE D	THIS DRAWING CONTAINS INFORMATION THAT IS PROPRIETARY TO MOLEX			
				SHEET NO. 1 OF 8			

# CONNECTOR ASSEMBLY WITHOUT CLIPSLOT

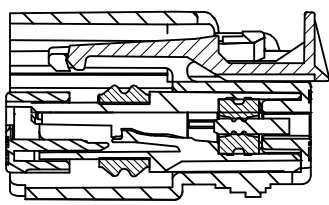

**SECTION A-A**  
TPA SHOWN IN AS-SHIPED  
PRE-LOCKED POSITION  
SEE NOTE 1c

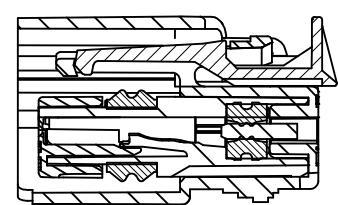

**SECTION A-A**  
TPA SHOWN IN FINAL  
LOCKED POSITION

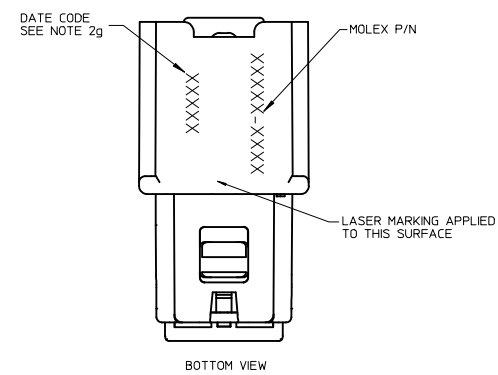

BOTTOM VIEW

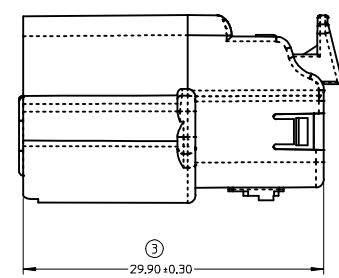
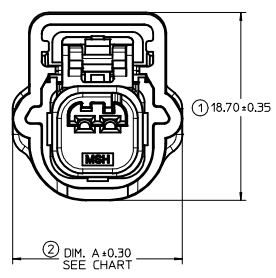
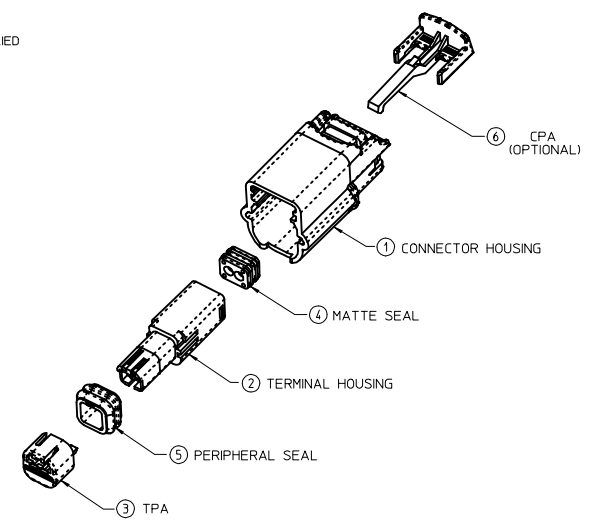

RIGHT SIDE VIEW

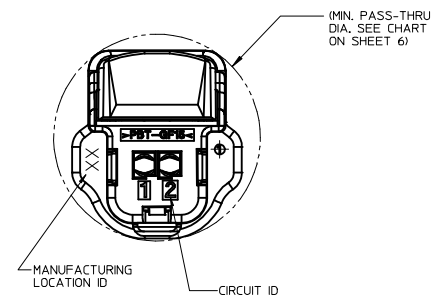

BACK VIEW

ITEM	DESCRIPTION	COLOR	MATERIAL
1	CONNECTOR HOUSING	SEE CHART	PBT GF15
2	TERMINAL HOUSING	BLACK	SPS/PA66 GF30
3	TPA	NATURAL	SPS/PA66 GF20
4	MATTE SEAL	SEE CHART	SILICONE RUBBER
5	PERIPHERAL SEAL	SEE CHART	SILICONE RUBBER
6	CPA - OPTIONAL	RED	PBT GF30

<b>REDRAW</b> EC NO: UAU2017-0056 DRAWN BY: M CHKD: APPR: IDEN02 2016/07/23 2016/07/26	QUALITY SYMBOLS	GENERAL TOLERANCES (UNLESS SPECIFIED)	DIMENSION STYLE	SCALE	DESIGN UNITS	THIRD ANGLE PROJECTION
	▽=0	mm INCH	MM ONLY	4:1	METRIC	
	▽=0	4 PLACES ± --- ± ---	RCARLSON 2003/09/25			0.64 USCAR CONNECTOR SEALED SINGLE ROW ASSEMBLY <b>molex</b>
	▽=0	3 PLACES ± --- ± ---	CHECKED BY DATE		DOCUMENT NO. SD-31402-211	
▽=0	2 PLACES ± 0.13 ± ---	RCARLSON 2004/09/28			SHEET NO. 2 OF 8	
	1 PLACE ± 0.3 ± ---	APPROVED BY DATE			THIS DRAWING CONTAINS INFORMATION THAT IS PROPRIETARY TO MOLEX INCORPORATED AND SHOULD NOT BE USED WITHOUT WRITTEN PERMISSION	
	0 PLACE ± ±	VKOSHY 2010/11/22				

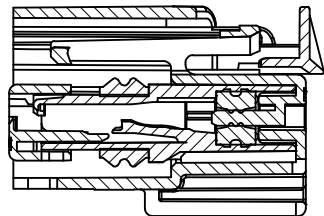

**SECTION C-C**  
TPA SHOWN IN AS-SHIPED  
PRE-LOCKED POSITION  
SEE NOTE 1c

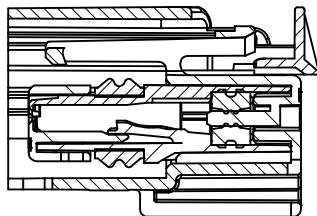

**SECTION C-C**  
TPA SHOWN IN FINAL  
LOCKED POSITION

DATE CODE  
SEE NOTE 2g

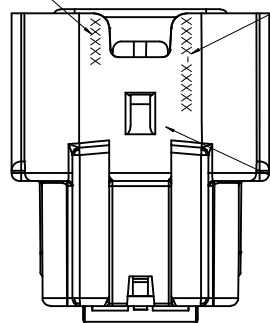

BOTTOM VIEW

MOLEX P/N

LASER MARKING APPLIED  
TO THIS SURFACE

# CONNECTOR ASSEMBLY WITH CLIPSLOT

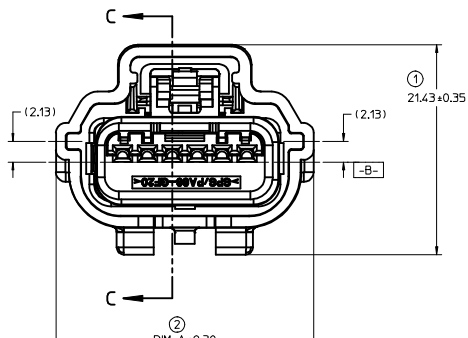
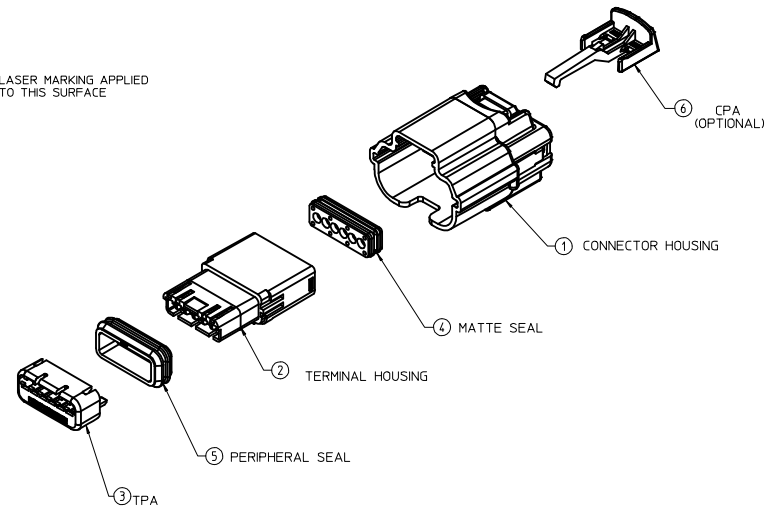

**POLARIZATION A**  
FRONT VIEW

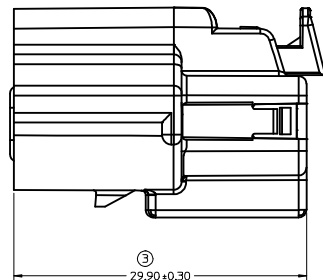

RIGHT SIDE VIEW

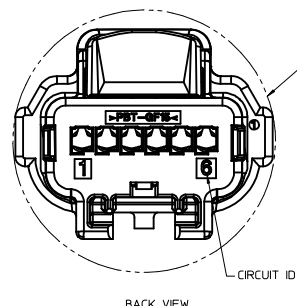

BACK VIEW

(MIN. PASS-THRU  
DIA. SEE CHART  
ON SHEET 7)

CIRCUIT ID

ITEM	DESCRIPTION	COLOR	MATERIAL
1	CONNECTOR HOUSING	SEE CHART	PBT GF15
2	TERMINAL HOUSING	BLACK	SPS/PA66 GF30
3	TPA	NATURAL	SPS/PA66 GF20
4	MATTE SEAL	SEE CHART	SILICONE RUBBER
5	PERIPHERAL SEAL	SEE CHART	SILICONE RUBBER
6	CPA - OPTIONAL	RED	PBT GF30

<b>REDRAW</b> EC NO: UAU2017-0056 DRAWN BY: CHKD CHKD: APPR: JENGG02 DATE: 2016/07/23 2016/07/26	QUALITY SYMBOLS ∇=0 ∇=0 ∇=0	GENERAL TOLERANCES (UNLESS SPECIFIED) mm INCH 4 PLACES ± --- ± --- 3 PLACES ± 0.13 ± --- 2 PLACES ± 0.3 ± --- 1 PLACE ± 0.3 ± --- 0 PLACE ± ± ---	DIMENSION STYLE <b>MM ONLY</b> DRAWN BY: R CARLSON CHECKED BY: R CARLSON APPROVED BY: WKOSHY DATE: 2003/09/25 DATE: 2004/09/28 DATE: 2010/11/22	SCALE: 4:1 DESIGN UNITS: METRIC THIRD ANGLE PROJECTION	TITLE: <b>0.64 USCAR CONNECTOR SEALED SINGLE ROW ASSEMBLY</b> <b>molex</b>	MATERIAL NO.: SEE CHART DOCUMENT NO.: SD-31402-211	SHEET NO.: 3 OF 8
	DRAFT WHERE APPLICABLE MUST REMAIN WITHIN DIMENSIONS		ANGULAR ± 3 °		THIS DRAWING CONTAINS INFORMATION THAT IS PROPRIETARY TO MOLEX INCORPORATED AND SHOULD NOT BE USED WITHOUT WRITTEN PERMISSION		

1X2

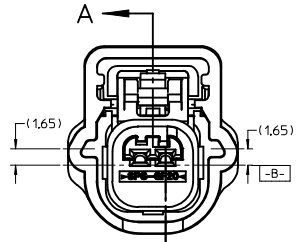

FRONT VIEW  
POLARIZATION A

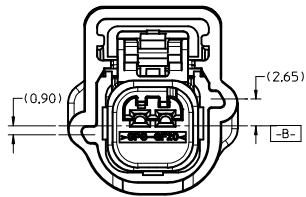

POLARIZATION B

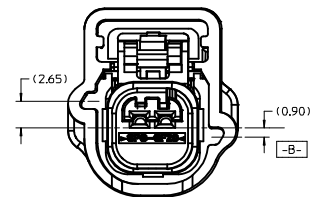

POLARIZATION C

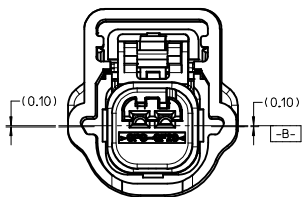

POLARIZATION D

1X3

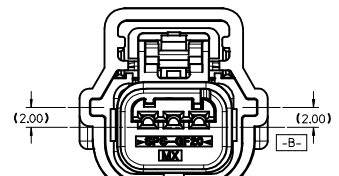

POLARIZATION A

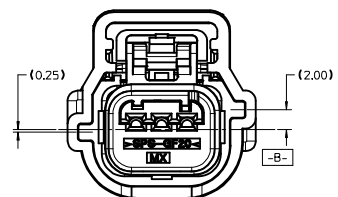

POLARIZATION B

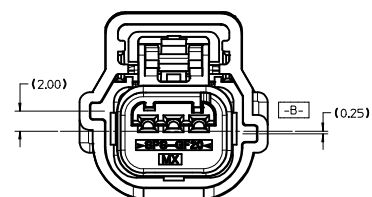

POLARIZATION C

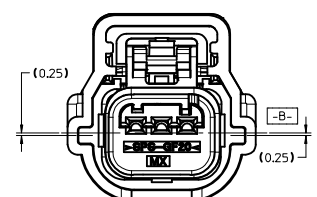

POLARIZATION D

1X4

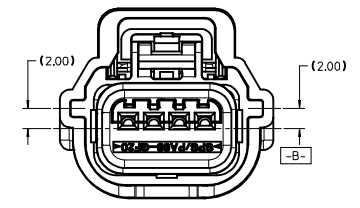

POLARIZATION A

# KEY CONFIGURATIONS

REDRAW  
EC NO: UAU2017-0056  
DRWDATE: 2016/07/23  
CHKD: CHYK  
APPR: JEN002  
REV

QUALITY SYMBOLS  
▽=0  
▽=1  
▽=2  
▽=3

GENERAL TOLERANCES (UNLESS SPECIFIED)	DIMENSION STYLE	
	mm	INCH
4 PLACES ±	---	±---
3 PLACES ±	---	±---
2 PLACES ±	0.13	±---
1 PLACE ±	0.3	±---
0 PLACE ±		±

DIMENSION STYLE		SCALE	DESIGN UNITS	THIRD ANGLE PROJECTION
MM ONLY		4:1	METRIC	<input checked="" type="checkbox"/>
DRAWN BY	DATE	TITLE		
RCARLSON	2003/09/25	0.64 USCAR CONNECTOR SEALED SINGLE ROW ASSEMBLY		
CHECKED BY	DATE			
RCARLSON	2004/09/28			
APPROVED BY	DATE	MATERIAL NO.		
VKOSHY	2010/11/22	SEE CHART		

DOCUMENT NO.	SHEET NO.
SD-31402-211	4 OF 8

THIS DRAWING CONTAINS INFORMATION THAT IS PROPRIETARY TO MOLEX INCORPORATED AND SHOULD NOT BE USED WITHOUT WRITTEN PERMISSION

1X5

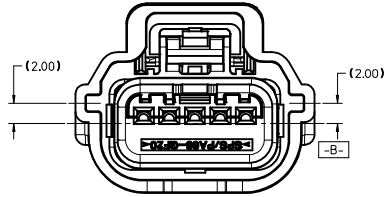

POLARIZATION A

1X6

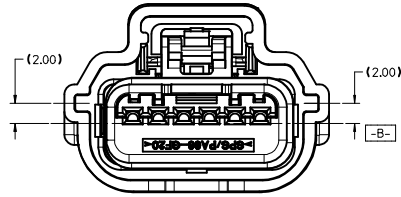

POLARIZATION A

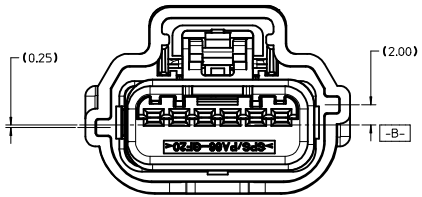

POLARIZATION B

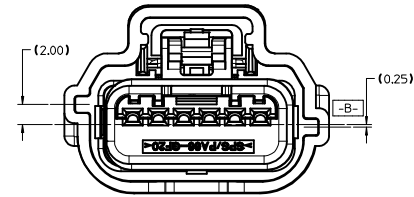

POLARIZATION C

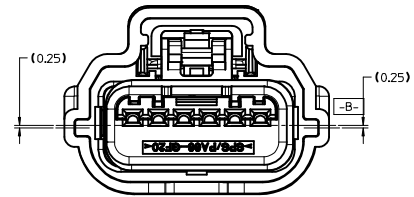

POLARIZATION D

1X8

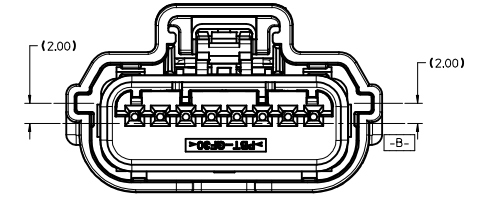

POLARIZATION A

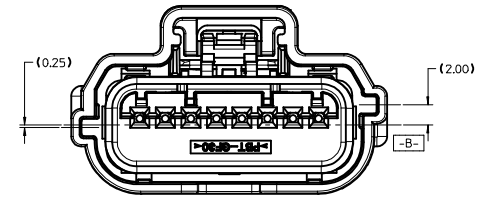

POLARIZATION B

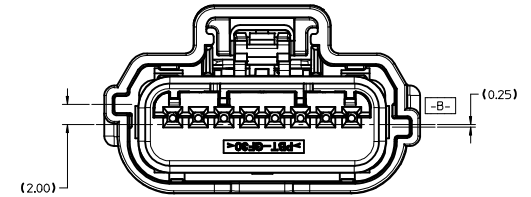

POLARIZATION C

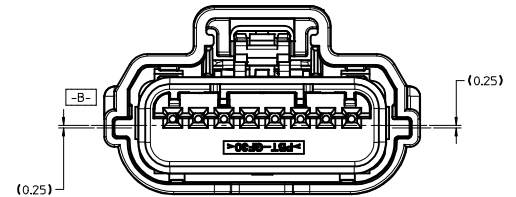

POLARIZATION D

# KEY CONFIGURATIONS

<b>REDRAW</b> EC NO: UAU2017-0056 DRAWN BY: 2016/07/23 CHKD: APPR: JDENG02 APPR: JDENG02	QUALITY SYMBOLS	GENERAL TOLERANCES (UNLESS SPECIFIED)	DIMENSION STYLE	SCALE	DESIGN UNITS	THIRD ANGLE PROJECTION																								
	$\nabla=0$ $\nabla=0$ $\nabla=0$	<table border="1"> <tr><th colspan="2">mm</th><th colspan="2">INCH</th></tr> <tr><td>4 PLACES</td><td>± .005</td><td>± .000</td><td></td></tr> <tr><td>3 PLACES</td><td>± .005</td><td>± .000</td><td></td></tr> <tr><td>2 PLACES</td><td>± 0.13</td><td>± .005</td><td></td></tr> <tr><td>1 PLACE</td><td>± 0.3</td><td>± .010</td><td></td></tr> <tr><td>0 PLACE</td><td>± .0</td><td>± .0</td><td></td></tr> </table>	mm		INCH		4 PLACES	± .005	± .000		3 PLACES	± .005	± .000		2 PLACES	± 0.13	± .005		1 PLACE	± 0.3	± .010		0 PLACE	± .0	± .0		<b>MM ONLY</b> DRAWN BY: RCARLSON DATE: 2003/09/25 CHECKED BY: RCARLSON DATE: 2004/09/28 APPROVED BY: VKOSHY DATE: 2010/11/22	4:1	METRIC	
	mm		INCH																											
	4 PLACES	± .005	± .000																											
3 PLACES	± .005	± .000																												
2 PLACES	± 0.13	± .005																												
1 PLACE	± 0.3	± .010																												
0 PLACE	± .0	± .0																												
MATERIAL NO. <b>SEE CHART</b>	ANGULAR ± 3° DRAFT WHERE APPLICABLE MUST REMAIN WITHIN DIMENSIONS	TITLE <b>0.64 USCAR CONNECTOR SEALED SINGLE ROW ASSEMBLY</b>	DOCUMENT NO. <b>SD-31402-211</b>	SHEET NO. <b>5 OF 8</b>																										
SIZE 	THIS DRAWING CONTAINS INFORMATION THAT IS PROPRIETARY TO MOLEX INCORPORATED AND SHOULD NOT BE USED WITHOUT WRITTEN PERMISSION																													

PART NUMBER WITHOUT CPA	PART NUMBER WITH CPA	CLIPSLOT OPTION	ROW/ CIRCUITS	KEY*	MATTE SEAL COLOR	PERIMETER SEAL COLOR	CONNECTOR COLOR	WIDTH DIM (A)	MIN. PASS THRU DIA.	FEMALE TERMINAL SUPPLIER	USCAR FOOTPRINT DRAWING NO.	STATUS	
31402-2100	31402-2110	NO	1 X 2	A	ROYAL BLUE	BLUE	BLACK	16.88	(20.80)	TYCO OR MOLEX GET 0.64	064-S-002-1-202	TOOLED	
31402-2200	31402-2210			B			GRAY					TOOLED	
31402-2300	31402-2310			C			BROWN					TOOLED, COLOR UNAVAILABLE	
31402-2400	31402-2410			D			GREEN					TOOLED, COLOR UNAVAILABLE	
31402-2500	31402-2510			B			BLACK					TOOLED	
31402-2600	31402-2610			C			BLACK					TOOLED	
31402-2700	31402-2710			D			BLACK					TOOLED	
31403-2000	31403-2010			D			DK. GRAY					TOOLED	
31403-2100	31403-2110			A			BLACK					TOOLED	
31403-2200	31403-2210			B			GRAY					TOOLED	
31403-2300	31403-2310			C			BROWN					TOOLED, COLOR UNAVAILABLE	
31403-2400	31403-2410			D			GREEN					TOOLED, COLOR UNAVAILABLE	
31403-2500	31403-2510			D			BLACK					TOOLED	
31403-2600	31403-2610			C			BLACK					TOOLED	
31403-2700	31403-2710			D			BLACK					TOOLED	
31403-2800	31403-2810			C			NATURAL					TOOLED	
31403-2900	31403-2910			D			GRAY					TOOLED	
31404-2100	31404-2110			A			BLACK					NOT TOOLED	
31404-2200	31404-2210		B	GRAY	NOT TOOLED								
31404-2300	31404-2310		C	BROWN	NOT TOOLED								
31404-2400	31404-2410		D	GREEN	NOT TOOLED								
31404-2500	31404-2510		B	BLACK	NOT TOOLED								
31404-2600	31404-2610		C	BLACK	NOT TOOLED								
31404-2700	31404-2710		D	BLACK	NOT TOOLED								
31402-3100	31402-3110		NO	1 X 3	A	LIGHT BLUE	RUST RED	BLACK	18.70	(22.00)	TYCO OR MOLEX GET 0.64	064-S-003-1-201	TOOLED
31402-3200	31402-3210				B			GRAY					TOOLED
31402-3300	31402-3310				C			BROWN					TOOLED, COLOR UNAVAILABLE
31402-3400	31402-3410				D			GREEN					TOOLED, COLOR UNAVAILABLE
31402-3500	31402-3510				B			BLACK					TOOLED
31402-3600	31402-3610				C			BLACK					TOOLED
31402-3700	31402-3710				D			BLACK					TOOLED
31403-3000	31403-3010				D			DK. GRAY					TOOLED
31403-3100	31403-3110				A			BLACK					TOOLED
31403-3200	31403-3210				B			GRAY					TOOLED
31403-3300	31403-3310				C			BROWN					TOOLED, COLOR UNAVAILABLE
31403-3400	31403-3410				D			GREEN					TOOLED, COLOR UNAVAILABLE
31403-3500	31403-3510	B			BLACK			TOOLED					
31403-3600	31403-3610	C			BLACK			TOOLED					
31403-3700	31403-3710	D			BLACK			TOOLED					
31403-3800	31403-3810	C			NATURAL			TOOLED					
31404-3100	31404-3110	A			BLACK			TOOLED					
31404-3200	31404-3210	B			GRAY			TOOLED					
31404-3300	31404-3310	C		BROWN	TOOLED, COLOR UNAVAILABLE								
31404-3400	31404-3410	D		GREEN	TOOLED, COLOR UNAVAILABLE								
31404-3500	31404-3510	B		BLACK	TOOLED								
31404-3600	31404-3610	C		BLACK	TOOLED								
31404-3700	31404-3710	D		BLACK	TOOLED								
31402-4100	31402-4110	NO		1 X 4	A	TBD	TBD	BLACK	21.25	(22.34)	TYCO OR MOLEX GET 0.64	064-S-004-1-202	NOT TOOLED
31402-4200	31402-4210				B			GRAY					NOT TOOLED
31402-4300	31402-4310				C			BROWN					NOT TOOLED
31402-4400	31402-4410				D			GREEN					NOT TOOLED
31402-4500	31402-4510				B			BLACK					NOT TOOLED
31402-4600	31402-4610				C			BLACK					NOT TOOLED
31402-4700	31402-4710				D			BLACK					NOT TOOLED
31403-4100	31403-4110				A			BLACK					NOT TOOLED
31403-4200	31403-4210				B			GRAY					NOT TOOLED
31403-4300	31403-4310				C			BROWN					NOT TOOLED
31403-4400	31403-4410				D			GREEN					NOT TOOLED
31403-4500	31403-4510				B			BLACK					NOT TOOLED
31403-4600	31403-4610				C			BLACK					NOT TOOLED
31403-4700	31403-4710		D		BLACK			NOT TOOLED					
31404-4100	31404-4110		A		BLACK			NOT TOOLED					
31404-4200	31404-4210		B		GRAY			NOT TOOLED					
31404-4300	31404-4310		C		BROWN			NOT TOOLED					
31404-4400	31404-4410		D		GREEN			NOT TOOLED					
31404-4500	31404-4510		B	BLACK	NOT TOOLED								
31404-4600	31404-4610		C	BLACK	NOT TOOLED								
31404-4700	31404-4710		D	BLACK	NOT TOOLED								
31404-4800	31404-4810		A	BLACK	NOT TOOLED								
31404-4900	31404-4910		B	GRAY	NOT TOOLED								
31404-5000	31404-5010		C	BROWN	NOT TOOLED								
31404-5100	31404-5110		D	GREEN	NOT TOOLED								
31404-5200	31404-5210		B	BLACK	NOT TOOLED								
31404-5300	31404-5310		C	BLACK	NOT TOOLED								
31404-5400	31404-5410		D	BLACK	NOT TOOLED								

<b>REDRAW</b> EC NO. UAU2017-0056 DRAWN BY CHYD CHECKED BY APPR: JENGG02 DATE 2016/07/28 REV DESCRIPTION	QUALITY SYMBOLS	GENERAL TOLERANCES (UNLESS SPECIFIED)	DIMENSION STYLE	SCALE	DESIGN UNITS	THIRD ANGLE PROJECTION
	▽=0	4 PLACES ± 0.13	MM ONLY	4:1	METRIC	0.64 USCAR CONNECTOR SEALED SINGLE ROW ASSEMBLY
	▽=0	3 PLACES ± 0.13				<b>molex</b>
	▽=0	2 PLACES ± 0.3	ANGULAR ± 3°	DRAFT WHERE APPLICABLE MUST REMAIN WITHIN DIMENSIONS	DRAWN BY DATE RCARLSON 2003/09/25	CHECKED BY DATE RCARLSON 2004/09/28
						MATERIAL NO. SEE CHART
						DOCUMENT NO. SD-31402-211
						SHEET NO. 6 OF 8

PART NUMBER WITHOUT CPA	PART NUMBER WITH CPA	CLIPSLIT OPTION	ROW/ CIRCUITS	KEY*	MATTE SEAL COLOR	PERIMETER SEAL COLOR	CONNECTOR COLOR	WIDTH DIM (A)	MIN. PASS THRU DIA.	FEMALE TERMINAL SUPPLIER	USCAR FOOTPRINT DRAWING NO.	STATUS
31402-5100	31402-5110	NO	1 X 5	A	TBD	TBD	BLACK	23.80	(24.28)	TYCO OR MOLEX GET 0.64	064-S-005-1-202	NOT TOOLED
31402-5200	31402-5210			B			GRAY					NOT TOOLED
31402-5300	31402-5310			C			BROWN					NOT TOOLED
31402-5400	31402-5410			D			GREEN					NOT TOOLED
31402-5500	31402-5510			B			BLACK					NOT TOOLED
31402-5600	31402-5610			C			BLACK					NOT TOOLED
31402-5700	31402-5710			D			BLACK					NOT TOOLED
31403-5100	31403-5110			A			BLACK					NOT TOOLED
31403-5200	31403-5210			B			GRAY					NOT TOOLED
31403-5300	31403-5310			C			BROWN					NOT TOOLED
31403-5400	31403-5410			D			GREEN			NOT TOOLED		
31403-5500	31403-5510			B			BLACK			NOT TOOLED		
31403-5600	31403-5610			C			BLACK			NOT TOOLED		
31403-5700	31403-5710			D			BLACK			NOT TOOLED		
31404-5100	31404-5110			A			BLACK			NOT TOOLED		
31404-5200	31404-5210			B			GRAY			NOT TOOLED		
31404-5300	31404-5310			C			BROWN			NOT TOOLED		
31404-5400	31404-5410			D			GREEN			NOT TOOLED		
31404-5500	31404-5510			B			BLACK			NOT TOOLED		
31404-5600	31404-5610			C			BLACK			NOT TOOLED		
31404-5700	31404-5710	D	BLACK	NOT TOOLED								
31402-6100	31402-6110	NO	1 X 6	A	ROYAL BLUE	LIGHT BLUE	BLACK	26.33	(26.82)	TYCO OR MOLEX GET 0.64	064-S-006-1-202	TOOLED
31402-6200	31402-6210			B			GRAY					TOOLED, COLOR UNAVAILABLE
31402-6300	31402-6310			C			BROWN					TOOLED, COLOR UNAVAILABLE
31402-6400	31402-6410			D			GREEN					TOOLED
31402-6500	31402-6510			B			BLACK					TOOLED
31402-6600	31402-6610			C			BLACK					TOOLED
31402-6700	31402-6710			D			BLACK					TOOLED
31403-6100	31403-6110			A			BLACK					TOOLED
31403-6200	31403-6210			B			GRAY					TOOLED
31403-6300	31403-6310			C			BROWN					TOOLED, COLOR UNAVAILABLE
31403-6400	31403-6410			D			GREEN			TOOLED, COLOR UNAVAILABLE		
31403-6500	31403-6510			B			BLACK			TOOLED		
31403-6600	31403-6610			C			BLACK			TOOLED		
31403-6700	31403-6710			D			BLACK			TOOLED		
31404-6100	31404-6110			A			BLACK			TOOLED		
31404-6200	31404-6210			B			GRAY			TOOLED		
31404-6300	31404-6310			C			BROWN			TOOLED, COLOR UNAVAILABLE		
31404-6400	31404-6410			D			GREEN			TOOLED, COLOR UNAVAILABLE		
31404-6500	31404-6510			B			BLACK			TOOLED		
31404-6600	31404-6610			C			BLACK			TOOLED		
31404-6700	31404-6710	D	BLACK	TOOLED								
31404-6800	31404-6810	C	NATURAL	TOOLED								

<b>REDRAW</b> EC NO. UAU2017-0056 DRAWN BY: 2016/07/23 CHKD: APPR.: JEN002 2016/07/26 DESCRIPTION:	QUALITY SYMBOLS	GENERAL TOLERANCES (UNLESS SPECIFIED)	DIMENSION STYLE	SCALE	DESIGN UNITS	THIRD ANGLE PROJECTION	
	∇=0 ∇=0 ∇=0	4 PLACES ± --- ± --- 3 PLACES ± --- ± --- 2 PLACES ± 0.13 ± --- 1 PLACE ± 0.3 ± --- 0 PLACE ± ±	mm    INCH ANGULAR ± 3 ° DRAFT WHERE APPLICABLE MUST REMAIN WITHIN DIMENSIONS	MM ONLY DRAWN BY: DATE RCARLSON 2003/09/25 CHECKED BY: DATE RCARLSON 2004/09/28 APPROVED BY: DATE VKOSHY 2010/11/22	4:1	METRIC	0.64 USCAR CONNECTOR SEALED SINGLE ROW ASSEMBLY <b>molex</b> MATERIAL NO. SD-31402-211 DOCUMENT NO. SD-31402-211 SHEET NO. 7 OF 8
	THIS DRAWING CONTAINS INFORMATION THAT IS PROPRIETARY TO MOLEX INCORPORATED AND SHOULD NOT BE USED WITHOUT WRITTEN PERMISSION						
	SIZE D						

PART NUMBER WITHOUT CPA	PART NUMBER WITH CPA	CLIPSLOT OPTION	ROW/ CIRCUITS	KEY	MATE SEAL COLOR	PERMETER SEAL COLOR	CONNECTOR COLOR	WIDTH DIM (A)	MIN. PASS THRU DIA.	FEMALE TERMINAL SUPPLIER	USCAR FOOTPRINT DRAWING NO.	STATUS
31402-8100	31402-8110	NO	1 X 8	A	TBD	TBD	BLACK	31.25	(31.90)	TYCO OR MOLEX GET 0.64	064-S-008-1-Z02	NOT TOOLED
31402-8200	31402-8210			B			GRAY					NOT TOOLED
31402-8300	31402-8310			C			BROWN					NOT TOOLED
31402-8400	31402-8410			D			GREEN					NOT TOOLED
31402-8500	31402-8510			B			BLACK					NOT TOOLED
31402-8600	31402-8610			C			BLACK					NOT TOOLED
31402-8700	31402-8710			D			BLACK					NOT TOOLED
31403-8100	31403-8110			A			BLACK					NOT TOOLED
31403-8200	31403-8210			B			GRAY					NOT TOOLED
31403-8300	31403-8310			C			BROWN					NOT TOOLED
31403-8400	31403-8410			D			GREEN					NOT TOOLED
31403-8500	31403-8510			B			BLACK					NOT TOOLED
31403-8600	31403-8610			C			BLACK					NOT TOOLED
31403-8700	31403-8710			D			BLACK					NOT TOOLED
31404-8100	31404-8110			A			BLACK			NOT TOOLED		
31404-8200	31404-8210			B			LT. GRAY			INFORMATION REFER TO SD-31404-811		
31404-8300	31404-8310			C			DK. GRAY					
31404-8400	31404-8410			D			TBD					

ADDITIONAL CAVITY PLUG CONFIGURATIONS:

ROW/ CIRCUITS	FEMALE TERMINAL	MOLEX P/N WITH CPA	MOLEX P/N WITHOUT CPA	KEY OPTION	CLIPSLOT OPTION	COLOR	CIRCUIT NUMBER: '0' INDICATED PLUG LOCATION						TOTAL CIRCUITS PLUGGED	STATUS
							1	2	3	4	5	6		
1X6	TYCO/MOLEX GET	31402-6110	31402-6100	A	NO	BLACK							0	TOOLED
		31402-6111	31402-6101	A	NO	BLACK	0	0	0	0	0	0	6	TOOLED
		31402-6112	31402-6102	A	NO	BLACK	0	0	0				2	TOOLED
		31402-6113	31402-6103	A	NO	BLACK							1	TOOLED
		31402-6114	31402-6104	A	NO	BLACK	0	0	0	0			4	TOOLED
		31402-6115	31402-6105	A	NO	BLACK				0	0	0	3	TOOLED
	31402-6118	31402-6108	A	NO	BLACK					0		1	TOOLED	
	31402-6150	31402-6140	A	YES	BLACK							0	TOOLED	
	31403-6110	31403-6100	A	NO	BLACK							0	TOOLED	
	31403-6111	31403-6101	A	NO	BLACK	0	0	0	0	0	0	6	TOOLED	
	31403-6112	31403-6102	A	NO	BLACK					0		1	TOOLED	
	31403-6113	31403-6103	A	NO	BLACK	0	0	0				4	TOOLED	
	31403-6114	31403-6104	A	NO	BLACK					0	0	2	TOOLED	
	31403-6212	31403-6202	B	NO	GRAY				0	0	0	3	TOOLED	
	31404-6110	31404-6100	A	NO	BLACK							0	TOOLED	
	31404-6111	31404-6101	A	NO	BLACK	0	0	0	0	0	0	6	TOOLED	
	31404-6112	31404-6102	A	NO	BLACK	0				0		2	TOOLED	
	31404-6113	31404-6103	A	NO	BLACK	0						2	TOOLED	
	31404-6116	31404-6106	A	NO	BLACK					0		1	TOOLED	
	31404-6117	31404-6107	A	NO	BLACK	0				0		3	TOOLED	
	31404-6118	31404-6108	A	NO	BLACK	0						1	TOOLED	
	31404-6119	31404-6109	A	NO	BLACK				0	0	0	3	TOOLED	
	31404-6132	31404-6122	A	NO	BLACK				0			1	TOOLED	
	31404-6213	31404-6203	B	NO	GRAY	0					0	2	TOOLED	
	31404-6214	31404-6204	B	NO	GRAY						0	1	TOOLED	
	31404-6812	31404-6802	C	NO	NATURAL					0	0	3	TOOLED	
	1X3	TYCO/MOLEX GET	31402-3113	31402-3103	A	NO	BLACK				0		1	TOOLED

<b>REDRAW</b> EC NO. UAU2017-0056 DRAWN BY M CHKD: APPR: JDENG02 REV DESCRIPTION 2016/07/28	QUALITY SYMBOLS ∇=0 ∇=0 ∇=0	GENERAL TOLERANCES (UNLESS SPECIFIED) mm INCH 4 PLACES ± --- ± --- 3 PLACES ± --- ± --- 2 PLACES ± 0.13 ± --- 1 PLACE ± 0.3 ± --- 0 PLACE ± ±	DIMENSION STYLE <b>MM ONLY</b>	SCALE <b>4:1</b>	DESIGN UNITS <b>METRIC</b>	THIRD ANGLE PROJECTION
	DRAWN BY DATE RCARLSON 2003/09/25		CHECKED BY DATE RCARLSON 2004/09/28		APPROVED BY DATE VKOSHY 2010/11/22	
	MATERIAL NO.		DOCUMENT NO.		SHEET NO.	
	SEE CHART		SD-31402-211		8 OF 8	