

1X2

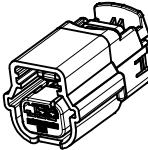

1X3

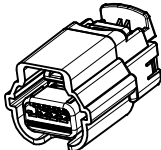

1X4

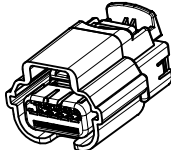

1X5

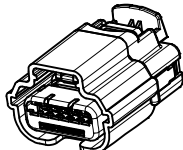

1X6

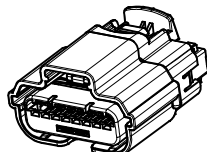

1X8

| TABLE OF CONTENTS |                                     |
|-------------------|-------------------------------------|
| SHEET NO.         | SHEET DESCRIPTION                   |
| 1                 | NOTES AND BOM                       |
| 2                 | CONNECTOR ASSEMBLY WITHOUT CLIPSLOT |
| 3                 | CONNECTOR ASSEMBLY WITH CLIPSLOT    |
| 4-5               | KEY CONFIGURATIONS                  |
| 6-8               | BOM                                 |

NOTES: VALID UNLESS OTHERWISE SPECIFIED

1. GENERAL:

- a. APPLICATION SPECIFICATION SEE: AS-31402-000
  - CONTAINS: SEE AS CONTENT
  - DESIGNED TO MATE WITH DEVICE OR CONNECTOR AS SPECIFIED IN THE MATING INTERFACE DRAWINGS CHART.
  - \*DENOTES DRAWINGS THAT CAN BE ACCESSED AT <http://ewcap.uscarteams.org/>.
  - ASSEMBLY SHIPPED WITH PLR IN PRE-LOCK POSITION (SEE PLR PRE-LOCK VIEW ON SHEET 2 SECTION A-A).
- b. PRODUCT RELATED DRAWING REFER TO DRAWING INFORMATION CHART
- c. TPA'S MAY BECOME SEATED DURING TRANSIT, IF THIS OCCURS, TPA'S SHOULD BE MOVED TO THE PRE-LOCKED POSITION PRIOR TO FEMALE TERMINAL INSTALLATION. REFERENCE PRODUCT SPECIFICATION: PS-34646-001
- d. PARTS MUST BE IN COMPLIANCE TO MOLEX CHEMICAL SUBSTANCES FOR PRODUCTS AND PACKAGING SPECIFICATION: QEH5-699000-301
- e. DATA MUST BE SUBMITTED UNDER THE MOLEX PART NUMBER TO IMDS (COMPANY ID#13255)
- f. SYSTEM EXCEPT SERIES 31404 1X8 CIRCUIT TO BE USED WITH OUTSIDE WIRE DIAMETERS RANGING FROM 1.20MM TO 2.06MM WITHIN RANGE OF:
  - SAE 22 AWG TO 18 AWG PER ESB-MIL123-A2
  - ISO 0.35MM<sup>2</sup> TO 0.75MM<sup>2</sup> PER GMW15626 AND ES-AU5T-1A348-AA
- g. POLARIZATION FEATURE EFFECTIVENESS PER USCAR-2 PARAGRAPH 5.4.4 IS REDUCED WHEN TESTING ALL POLARIZATION OPTIONS: 100N MIN.
- h. SEE SHEET #3 FOR CONNECTOR ASSEMBLY WITH CLIPSLOT
- i. FOR CLIPSLOT CONNECTOR: CLIP OVERHANGS CONNECTOR, PLEASE CHECK APPLICATION (COULD CAUSE WIRE CHAFING)-SHORTER CLIP IS A RECOMMENDATION.

2. DESIGN - GEOMETRY:

- a. THE 3-D CAD DATA IS BASIC (WITHOUT TOLERANCE) AND MASTER FOR THIS PART WITH THE EXCEPTION OF UNDERLINED DIMENSIONS. DIMENSIONAL INFORMATION NOT SHOWN ON THIS DRAWING IS DEFINED BY THE DATA FILE AT ITS LATEST REVISION.
- b. GEOMETRIC DIMENSIONS AND TOLERANCES PER ASME Y14.5M-2009
- c. EDGES AND UNDIMENSIONED DETAILS PER ISO13715
- d. CORNERS SHOWN AS SHARP TO BE R 0.2 MAX.
- e. LETTERING SHALL BE 0.15 MAX RAISED IN 0.25 MAX RECESS PAD. THIS INCLUDES RECYCLING CODE, CAVITY ID, VENDOR IDENTIFICATION, AND CUSTOMER MATERIAL NUMBER.
- f. VISUAL DEFECTS SHALL MEET COSMETIC STANDARD PS-45499-002 (Class B).
- g. DATE CODE: FIRST TWO DIGITS ARE THE CALENDAR YEAR (EXAMPLE: 04 = 2004). THIRD THROUGH 5TH DIGIT DAY # OF THE CALENDAR YEAR (EXAMPLE: FEB. 3RD = '034').

DRAWING INFORMATION

| DESCRIPTION           | DRAWING NO.   |
|-----------------------|---|
| PRODUCT SPECIFICATION | PS-31402-000<br>FOR 31404 1X8 REFER TO PS-31404-001-1X8 |
| PACKAGING             | PK-31300-256  |
| SALES DRAWING         | SD-31402-211<br>FOR 31404 1X8 REFER TO SD-31404-811     |
| TEST SUMMARY          | FOR 1X2 REFER TO TS-31402-001-1X2                       |
|                       | FOR 1X3 REFER TO TS-31402-001-1X3                       |
|                       | FOR 1X6 REFER TO TS-31402-001-1X6                       |
|                       | FOR 31404 1X8 REFER TO TS-31404-001-1X8                 |

MATING INTERFACE DRAWING

| DESCRIPTION | INTERFACE DEFINITION |
|-------------|----------------------|
| 1X2         | *064-S-002-1-Z02     |
| 1X3         | *064-S-003-1-Z01     |
| 1X4         | *064-S-004-1-Z02     |
| 1X5         | *064-S-005-1-Z02     |
| 1X6         | *064-S-006-1-Z02     |
| 1X8         | *064-S-008-1-Z02     |

PART NUMBER LEGEND  
CONNECTOR ASSEMBLY

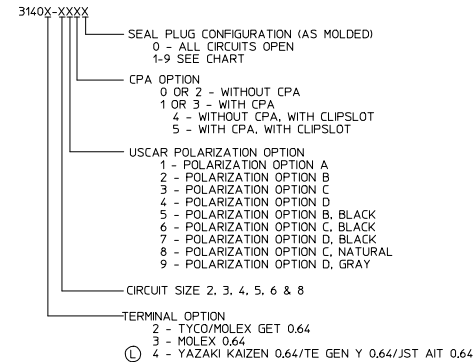

|     |  |
|-----|--|
| M   | ADD P/N: 31402-6118, 31402-6108  |
| L   | 1. REDRAW SALES DRAWING<br>2. UPDATE TERMINAL INFORMATION FOR 31404 SERIES<br>3. ADD P/N: 31403-6212, 31403-6202 |
| REV | REV DESCRIPTION  |

|  |                 |   |   |  |  |                        |  |
|--|-----------------|---|---|--|--|------------------------|--|
| <b>REDRAW</b><br>EC NO: UAU2017-0056<br>DRAWN BY: 2016/07/23<br>CHKD:<br>APPR: IDEN602 2016/07/26<br>REV | QUALITY SYMBOLS | GENERAL TOLERANCES (UNLESS SPECIFIED)   | DIMENSION STYLE   | SCALE  | DESIGN UNITS   | THIRD ANGLE PROJECTION |  |
|  | ▽=0             | mm INCH   | MM ONLY   | 4:1  | METRIC   |                        |  |
|  | ▽=0             | 4 PLACES ± --- ± ---<br>3 PLACES ± --- ± ---<br>2 PLACES ± 0.13 ± ---<br>1 PLACE ± 0.3 ± ---<br>0 PLACE ± ± | DRAWN BY: RCARLSON<br>CHECKED BY: RCARLSON<br>APPROVED BY: VKOSHY | DATE: 2003/09/25<br>DATE: 2004/09/28<br>DATE: 2010/11/22 | TITLE: 0.64 USCAR CONNECTOR SEALED SINGLE ROW ASSEMBLY<br><b>molex</b> |                        |  |
|  | ▽=0             | ANGULAR ± 3 °<br>DRAFT WHERE APPLICABLE MUST REMAIN WITHIN DIMENSIONS                                       | MATERIAL NO. SEE CHART<br>SIZE D                                  | DOCUMENT NO. SD-31402-211                                | SHEET NO. 1 OF 8   |                        |  |
| THIS DRAWING CONTAINS INFORMATION THAT IS PROPRIETARY TO MOLEX   |                 |   |   |  |  |                        |  |

# CONNECTOR ASSEMBLY WITHOUT CLIPSLOT

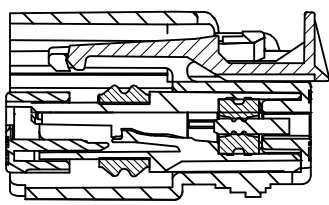

**SECTION A-A**  
TPA SHOWN IN AS-SHIPED  
PRE-LOCKED POSITION  
SEE NOTE 1c

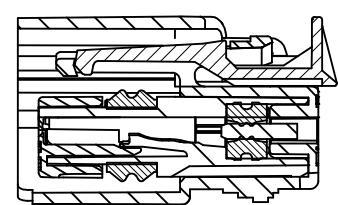

**SECTION A-A**  
TPA SHOWN IN FINAL  
LOCKED POSITION

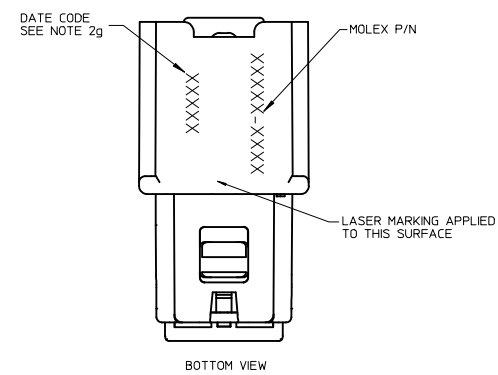

BOTTOM VIEW

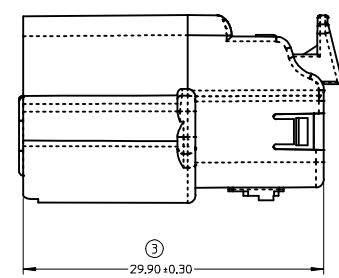
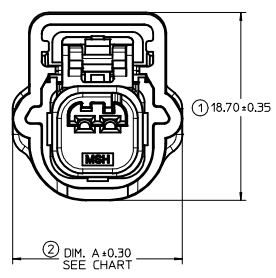
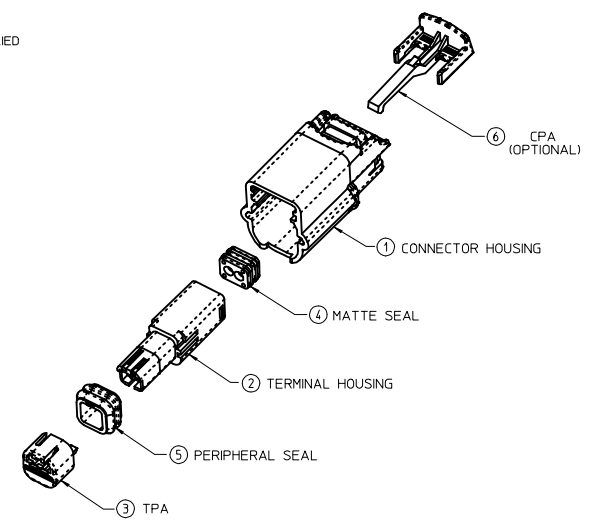

RIGHT SIDE VIEW

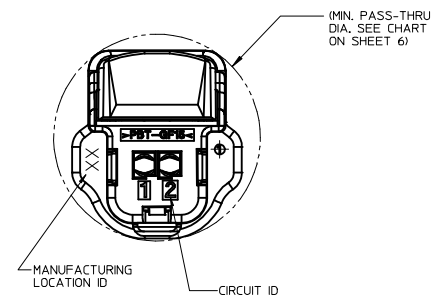

BACK VIEW

| ITEM | DESCRIPTION       | COLOR     | MATERIAL        |
|------|-------------------|-----------|-----------------|
| 1    | CONNECTOR HOUSING | SEE CHART | PBT GF15        |
| 2    | TERMINAL HOUSING  | BLACK     | SPS/PA66 GF30   |
| 3    | TPA               | NATURAL   | SPS/PA66 GF20   |
| 4    | MATTE SEAL        | SEE CHART | SILICONE RUBBER |
| 5    | PERIPHERAL SEAL   | SEE CHART | SILICONE RUBBER |
| 6    | CPA - OPTIONAL    | RED       | PBT GF30        |

|  |                       |  |                     |   |              |                        |
|--|-----------------------|--|---------------------|---|--------------|------------------------|
| <b>REDRAW</b><br>EC NO: UAU2017-0056<br>DRAWN BY: 2016/07/23<br>CHKD: M<br>APPR: IDEN02 2016/07/26 | QUALITY SYMBOLS       | GENERAL TOLERANCES (UNLESS SPECIFIED)                | DIMENSION STYLE     | SCALE   | DESIGN UNITS | THIRD ANGLE PROJECTION |
|  | ▽=0                   | mm INCH  | MM ONLY             | 4:1   | METRIC       |                        |
|  | ▽=0                   | 4 PLACES ± --- ± ---                                 | RCARLSON 2003/09/25 | TITLE   |              |                        |
|  | ▽=0                   | 3 PLACES ± --- ± ---                                 | CHECKED BY DATE     | <b>0.64 USCAR CONNECTOR<br/>SEALED SINGLE ROW<br/>ASSEMBLY</b><br><b>molex</b>  |              |                        |
| ▽=0  | 2 PLACES ± 0.13 ± --- | RCARLSON 2004/09/28                                  |                     |   |              |                        |
|  |                       | 1 PLACE ± 0.3 ± ---                                  | APPROVED BY DATE    | DOCUMENT NO.  |              |                        |
|  |                       | 0 PLACE ± ±  | VKOSHY 2010/11/22   | SD-31402-211  |              |                        |
|  |                       | ANGULAR ± 3°   | MATERIAL NO.        | SHEET NO.   |              |                        |
|  |                       | DRAFT WHERE APPLICABLE MUST REMAIN WITHIN DIMENSIONS | SEE CHART           | 2 OF 8  |              |                        |
|  |                       |  | SIZE 1              | THIS DRAWING CONTAINS INFORMATION THAT IS PROPRIETARY TO MOLEX INCORPORATED AND SHOULD NOT BE USED WITHOUT WRITTEN PERMISSION |              |                        |

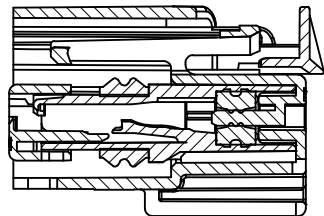

**SECTION C-C**  
TPA SHOWN IN AS-SHIPED  
PRE-LOCKED POSITION  
SEE NOTE 1c

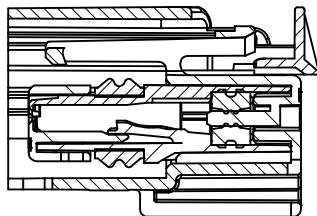

**SECTION C-C**  
TPA SHOWN IN FINAL  
LOCKED POSITION

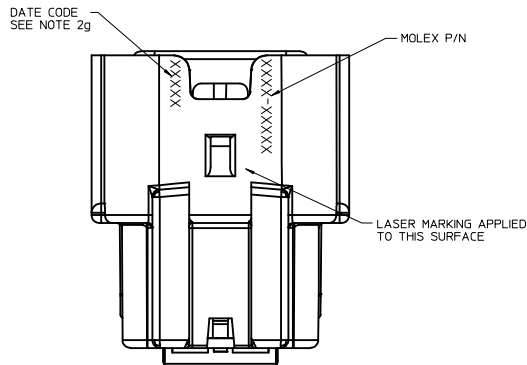

BOTTOM VIEW

# CONNECTOR ASSEMBLY WITH CLIPSLOT

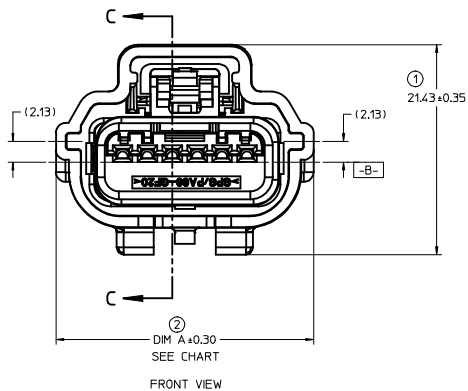
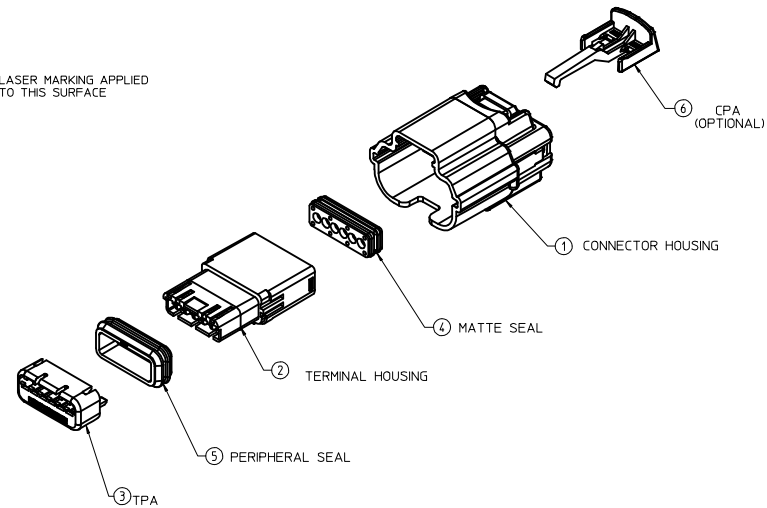

**POLARIZATION A**

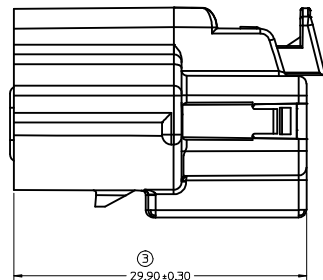

RIGHT SIDE VIEW

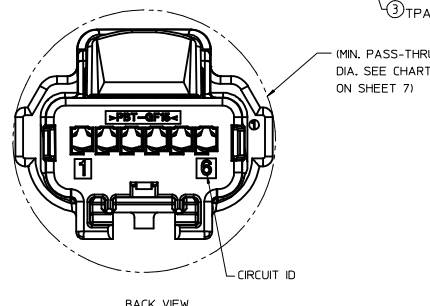

BACK VIEW

| ITEM | DESCRIPTION       | COLOR     | MATERIAL        |
|------|-------------------|-----------|-----------------|
| 1    | CONNECTOR HOUSING | SEE CHART | PBT GF15        |
| 2    | TERMINAL HOUSING  | BLACK     | SPS/PA66 GF30   |
| 3    | TPA               | NATURAL   | SPS/PA66 GF20   |
| 4    | MATTE SEAL        | SEE CHART | SILICONE RUBBER |
| 5    | PERIPHERAL SEAL   | SEE CHART | SILICONE RUBBER |
| 6    | CPA - OPTIONAL    | RED       | PBT GF30        |

|   |  |   |  |   |  |                     |
|---|--|---|--|---|--|---------------------|
| <b>REDRAW</b><br>EC NO: UAU2017-0056<br>DRAWN BY: CHKD<br>CHKD: APPR: JENGG02<br>DATE: 2016/07/23<br>2016/07/26 | QUALITY SYMBOLS<br>∇=0<br>∇=0<br>∇=0                 | GENERAL TOLERANCES (UNLESS SPECIFIED)<br>mm INCH<br>4 PLACES ± --- ± ---<br>3 PLACES ± 0.13 ± ---<br>2 PLACES ± 0.3 ± ---<br>1 PLACE ± 0.3 ± ---<br>0 PLACE ± ± --- | DIMENSION STYLE<br>MM ONLY<br>SCALE 4:1<br>DESIGN UNITS METRIC<br>THIRD ANGLE PROJECTION | DRAWN BY: R CARLSON<br>CHECKED BY: R CARLSON<br>APPROVED BY: WKOSHY<br>DATE: 2003/09/25<br>DATE: 2004/09/28<br>DATE: 2010/11/22 | TITLE<br>0.64 USCAR CONNECTOR SEALED SINGLE ROW ASSEMBLY<br><b>molex</b><br>MATERIAL NO. SD-31402-211<br>DOCUMENT NO. SD-31402-211 | SHEET NO.<br>3 OF 8 |
|   | DRAFT WHERE APPLICABLE MUST REMAIN WITHIN DIMENSIONS |   |  | SEE CHART   | THIS DRAWING CONTAINS INFORMATION THAT IS PROPRIETARY TO MOLEX INCORPORATED AND SHOULD NOT BE USED WITHOUT WRITTEN PERMISSION      |                     |
|   | ANGULAR ± 3 °  |   |  |   |  |                     |
|   | SIZE D   |   |  |   |  |                     |

1X2

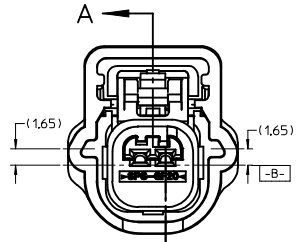

FRONT VIEW  
POLARIZATION A

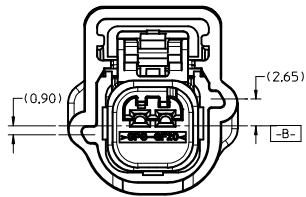

POLARIZATION B

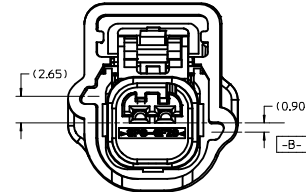

POLARIZATION C

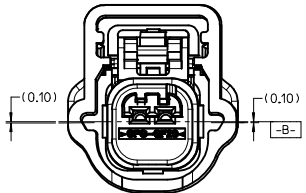

POLARIZATION D

1X3

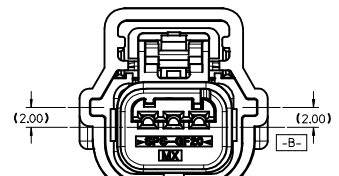

POLARIZATION A

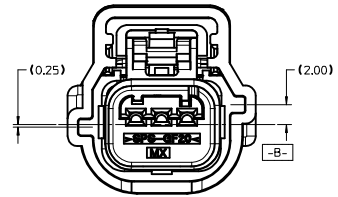

POLARIZATION B

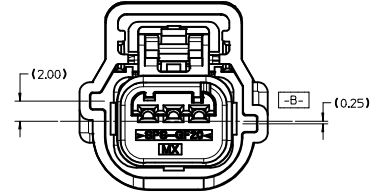

POLARIZATION C

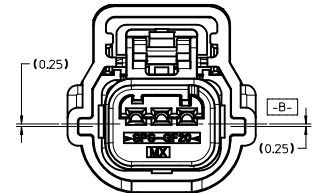

POLARIZATION D

1X4

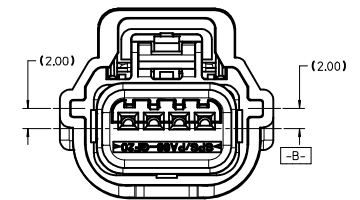

POLARIZATION A

# KEY CONFIGURATIONS

REDRAW  
EC NO: UAU2017-0056  
DRWDATE: 2016/07/23  
CHKD: CHYK  
APPR: JEN002  
REV

QUALITY SYMBOLS  
▽=0  
▽=1  
▽=2  
▽=3

|          | GENERAL TOLERANCES (UNLESS SPECIFIED) |        |
|----------|---------------------------------------|--------|
|          | mm                                    | INCH   |
| 4 PLACES | ± .13                                 | ± .005 |
| 3 PLACES | ± .15                                 | ± .006 |
| 2 PLACES | ± 0.13                                | ± .005 |
| 1 PLACE  | ± 0.3                                 | ± .012 |
| 0 PLACE  | ±                                     | ±      |

ANGULAR ± 3°  
DRAFT WHERE APPLICABLE MUST REMAIN WITHIN DIMENSIONS

| DIMENSION STYLE |            |
|-----------------|------------|
| MM ONLY         |            |
| DRAWN BY        | DATE       |
| RCARLSON        | 2003/09/25 |
| CHECKED BY      | DATE       |
| RCARLSON        | 2004/09/28 |
| APPROVED BY     | DATE       |
| VKOSHY          | 2010/11/22 |

| SCALE | DESIGN UNITS | THIRD ANGLE PROJECTION |
|-------|--------------|------------------------|
| 4:1   | METRIC       |                        |

TITLE: 0.64 USCAR CONNECTOR SEALED SINGLE ROW ASSEMBLY

MATERIAL NO. SEE CHART

DOCUMENT NO. SD-31402-211

SHEET NO. 4 OF 8

THIS DRAWING CONTAINS INFORMATION THAT IS PROPRIETARY TO MOLEX INCORPORATED AND SHOULD NOT BE USED WITHOUT WRITTEN PERMISSION

1X5

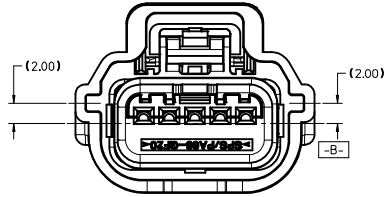

POLARIZATION A

1X6

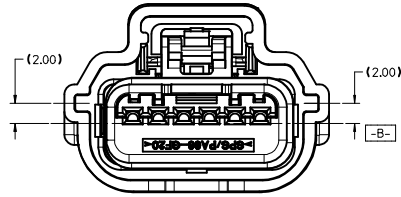

POLARIZATION A

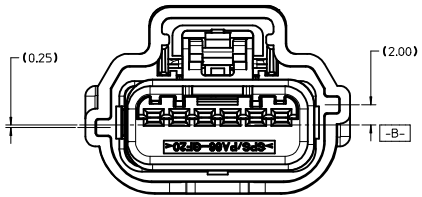

POLARIZATION B

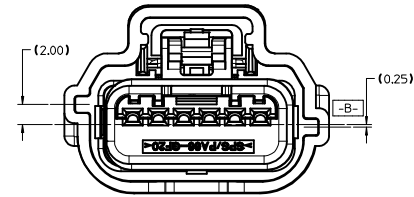

POLARIZATION C

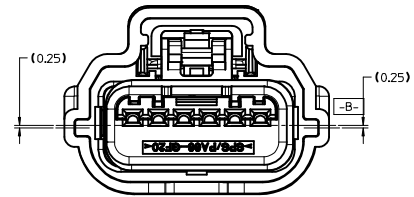

POLARIZATION D

1X8

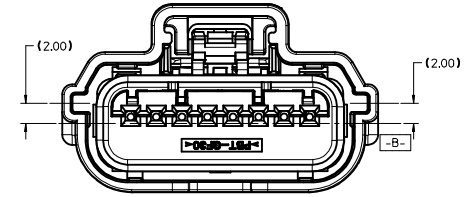

POLARIZATION A

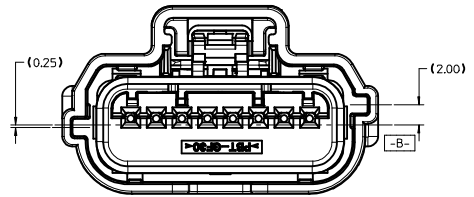

POLARIZATION B

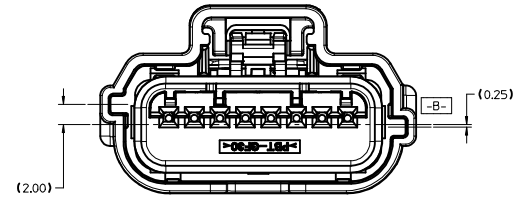

POLARIZATION C

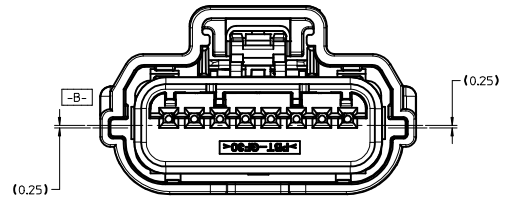

POLARIZATION D

# KEY CONFIGURATIONS

| <b>REDRAW</b><br>EC NO: UAU2017-0056<br>DRAWN BY: 2016/07/23<br>CHKD: APPR: JDENG02<br>APPR: JDENG02 | QUALITY SYMBOLS   | GENERAL TOLERANCES (UNLESS SPECIFIED)   | DIMENSION STYLE   | SCALE                               | DESIGN UNITS               | THIRD ANGLE PROJECTION |       |       |          |       |       |          |        |       |         |       |       |         |   |   |  |         |  |          |      |          |            |            |      |          |            |             |      |        |            |     |        |  |
|--|---|---|---|-------------------------------------|----------------------------|------------------------|-------|-------|----------|-------|-------|----------|--------|-------|---------|-------|-------|---------|---|---|--|---------|--|----------|------|----------|------------|------------|------|----------|------------|-------------|------|--------|------------|-----|--------|--|
|  | $\nabla=0$<br>$\nabla=0$<br>$\nabla=0$                                  | <table border="1"> <tr><th colspan="2">mm</th><th>INCH</th></tr> <tr><td>4 PLACES</td><td>± ---</td><td>± ---</td></tr> <tr><td>3 PLACES</td><td>± ---</td><td>± ---</td></tr> <tr><td>2 PLACES</td><td>± 0.13</td><td>± ---</td></tr> <tr><td>1 PLACE</td><td>± 0.3</td><td>± ---</td></tr> <tr><td>0 PLACE</td><td>±</td><td>±</td></tr> </table> | mm  |                                     | INCH                       | 4 PLACES               | ± --- | ± --- | 3 PLACES | ± --- | ± --- | 2 PLACES | ± 0.13 | ± --- | 1 PLACE | ± 0.3 | ± --- | 0 PLACE | ± | ± | <table border="1"> <tr><th colspan="2">MM ONLY</th></tr> <tr><td>DRAWN BY</td><td>DATE</td></tr> <tr><td>RCARLSON</td><td>2003/09/25</td></tr> <tr><td>CHECKED BY</td><td>DATE</td></tr> <tr><td>RCARLSON</td><td>2004/09/28</td></tr> <tr><td>APPROVED BY</td><td>DATE</td></tr> <tr><td>VKOSHY</td><td>2010/11/22</td></tr> </table> | MM ONLY |  | DRAWN BY | DATE | RCARLSON | 2003/09/25 | CHECKED BY | DATE | RCARLSON | 2004/09/28 | APPROVED BY | DATE | VKOSHY | 2010/11/22 | 4:1 | METRIC |  |
|  | mm  |   | INCH  |                                     |                            |                        |       |       |          |       |       |          |        |       |         |       |       |         |   |   |  |         |  |          |      |          |            |            |      |          |            |             |      |        |            |     |        |  |
|  | 4 PLACES  | ± ---   | ± ---   |                                     |                            |                        |       |       |          |       |       |          |        |       |         |       |       |         |   |   |  |         |  |          |      |          |            |            |      |          |            |             |      |        |            |     |        |  |
| 3 PLACES   | ± ---   | ± ---   |   |                                     |                            |                        |       |       |          |       |       |          |        |       |         |       |       |         |   |   |  |         |  |          |      |          |            |            |      |          |            |             |      |        |            |     |        |  |
| 2 PLACES   | ± 0.13  | ± ---   |   |                                     |                            |                        |       |       |          |       |       |          |        |       |         |       |       |         |   |   |  |         |  |          |      |          |            |            |      |          |            |             |      |        |            |     |        |  |
| 1 PLACE  | ± 0.3   | ± ---   |   |                                     |                            |                        |       |       |          |       |       |          |        |       |         |       |       |         |   |   |  |         |  |          |      |          |            |            |      |          |            |             |      |        |            |     |        |  |
| 0 PLACE  | ±   | ±   |   |                                     |                            |                        |       |       |          |       |       |          |        |       |         |       |       |         |   |   |  |         |  |          |      |          |            |            |      |          |            |             |      |        |            |     |        |  |
| MM ONLY  |   |   |   |                                     |                            |                        |       |       |          |       |       |          |        |       |         |       |       |         |   |   |  |         |  |          |      |          |            |            |      |          |            |             |      |        |            |     |        |  |
| DRAWN BY   | DATE  |   |   |                                     |                            |                        |       |       |          |       |       |          |        |       |         |       |       |         |   |   |  |         |  |          |      |          |            |            |      |          |            |             |      |        |            |     |        |  |
| RCARLSON   | 2003/09/25  |   |   |                                     |                            |                        |       |       |          |       |       |          |        |       |         |       |       |         |   |   |  |         |  |          |      |          |            |            |      |          |            |             |      |        |            |     |        |  |
| CHECKED BY   | DATE  |   |   |                                     |                            |                        |       |       |          |       |       |          |        |       |         |       |       |         |   |   |  |         |  |          |      |          |            |            |      |          |            |             |      |        |            |     |        |  |
| RCARLSON   | 2004/09/28  |   |   |                                     |                            |                        |       |       |          |       |       |          |        |       |         |       |       |         |   |   |  |         |  |          |      |          |            |            |      |          |            |             |      |        |            |     |        |  |
| APPROVED BY  | DATE  |   |   |                                     |                            |                        |       |       |          |       |       |          |        |       |         |       |       |         |   |   |  |         |  |          |      |          |            |            |      |          |            |             |      |        |            |     |        |  |
| VKOSHY   | 2010/11/22  |   |   |                                     |                            |                        |       |       |          |       |       |          |        |       |         |       |       |         |   |   |  |         |  |          |      |          |            |            |      |          |            |             |      |        |            |     |        |  |
| DESCRIPTION  | ANGULAR ± 3°<br>DRAFT WHERE APPLICABLE<br>MUST REMAIN WITHIN DIMENSIONS | SEE CHART<br>THIS DRAWING CONTAINS INFORMATION THAT IS PROPRIETARY TO MOLEX<br>INCORPORATED AND SHOULD NOT BE USED WITHOUT WRITTEN PERMISSION   | TITLE<br><b>0.64 USCAR CONNECTOR SEALED SINGLE ROW ASSEMBLY</b> | DOCUMENT NO.<br><b>SD-31402-211</b> | SHEET NO.<br><b>5 OF 8</b> |                        |       |       |          |       |       |          |        |       |         |       |       |         |   |   |  |         |  |          |      |          |            |            |      |          |            |             |      |        |            |     |        |  |

| PART NUMBER WITHOUT CPA | PART NUMBER WITH CPA | CLIPSLOT OPTION | ROW/ CIRCUITS | KEY*  | MATTE SEAL COLOR          | PERIMETER SEAL COLOR | CONNECTOR COLOR | WIDTH DIM (A) | MIN. PASS THRU DIA. | FEMALE TERMINAL SUPPLIER | USCAR FOOTPRINT DRAWING NO. | STATUS                    |                           |
|-------------------------|----------------------|-----------------|---------------|-------|---------------------------|----------------------|-----------------|---------------|---------------------|--------------------------|-----------------------------|---------------------------|---------------------------|
| 31402-2100              | 31402-2110           | NO              | 1 X 2         | A     | ROYAL BLUE                | BLUE                 | BLACK           | 16.88         | (20.80)             | TYCO OR MOLEX GET 0.64   | 064-S-002-1-Z02             | TOOLED                    |                           |
| 31402-2200              | 31402-2210           |                 |               | B     |                           |                      | GRAY            |               |                     |                          |                             | TOOLED                    |                           |
| 31402-2300              | 31402-2310           |                 |               | C     |                           |                      | BROWN           |               |                     |                          |                             | TOOLED, COLOR UNAVAILABLE |                           |
| 31402-2400              | 31402-2410           |                 |               | D     |                           |                      | GREEN           |               |                     |                          |                             | TOOLED, COLOR UNAVAILABLE |                           |
| 31402-2500              | 31402-2510           |                 |               | B     |                           |                      | BLACK           |               |                     |                          |                             | TOOLED                    |                           |
| 31402-2600              | 31402-2610           |                 |               | C     |                           |                      | BLACK           |               |                     |                          |                             | TOOLED                    |                           |
| 31402-2700              | 31402-2710           |                 |               | D     |                           |                      | BLACK           |               |                     |                          |                             | TOOLED                    |                           |
| 31403-2000              | 31403-2010           |                 |               | D     |                           |                      | DK. GRAY        |               |                     |                          |                             | TOOLED                    |                           |
| 31403-2100              | 31403-2110           |                 |               | A     |                           |                      | BLACK           |               |                     |                          |                             | TOOLED                    |                           |
| 31403-2200              | 31403-2210           |                 |               | B     |                           |                      | GRAY            |               |                     |                          |                             | TOOLED                    |                           |
| 31403-2300              | 31403-2310           |                 |               | C     |                           |                      | BROWN           |               |                     |                          |                             | TOOLED, COLOR UNAVAILABLE |                           |
| 31403-2400              | 31403-2410           |                 |               | D     |                           |                      | GREEN           |               |                     |                          |                             | TOOLED, COLOR UNAVAILABLE |                           |
| 31403-2500              | 31403-2510           |                 |               | D     |                           |                      | BLACK           |               |                     |                          |                             | TOOLED                    |                           |
| 31403-2600              | 31403-2610           |                 |               | C     |                           |                      | BLACK           |               |                     |                          |                             | TOOLED                    |                           |
| 31403-2700              | 31403-2710           |                 |               | D     |                           |                      | BLACK           |               |                     |                          |                             | TOOLED                    |                           |
| 31403-2800              | 31403-2810           |                 |               | C     |                           |                      | NATURAL         |               |                     |                          |                             | TOOLED                    |                           |
| 31403-2900              | 31403-2910           |                 |               | D     |                           |                      | GRAY            |               |                     |                          |                             | TOOLED                    |                           |
| 31404-2100              | 31404-2110           |                 |               | A     |                           |                      | BLACK           |               |                     |                          |                             | NOT TOOLED                |                           |
| 31404-2200              | 31404-2210           |                 | B             | GRAY  | NOT TOOLED                |                      |                 |               |                     |                          |                             |                           |                           |
| 31404-2300              | 31404-2310           |                 | C             | BROWN | NOT TOOLED                |                      |                 |               |                     |                          |                             |                           |                           |
| 31404-2400              | 31404-2410           |                 | D             | GREEN | NOT TOOLED                |                      |                 |               |                     |                          |                             |                           |                           |
| 31404-2500              | 31404-2510           |                 | B             | BLACK | NOT TOOLED                |                      |                 |               |                     |                          |                             |                           |                           |
| 31404-2600              | 31404-2610           |                 | C             | BLACK | NOT TOOLED                |                      |                 |               |                     |                          |                             |                           |                           |
| 31404-2700              | 31404-2710           |                 | D             | BLACK | NOT TOOLED                |                      |                 |               |                     |                          |                             |                           |                           |
| 31402-3100              | 31402-3110           |                 | NO            | 1 X 3 | A                         | LIGHT BLUE           | RUST RED        | BLACK         | 18.70               | (22.00)                  | TYCO OR MOLEX GET 0.64      | 064-S-003-1-Z01           | TOOLED                    |
| 31402-3200              | 31402-3210           |                 |               |       | B                         |                      |                 | GRAY          |                     |                          |                             |                           | TOOLED                    |
| 31402-3300              | 31402-3310           |                 |               |       | C                         |                      |                 | BROWN         |                     |                          |                             |                           | TOOLED, COLOR UNAVAILABLE |
| 31402-3400              | 31402-3410           |                 |               |       | D                         |                      |                 | GREEN         |                     |                          |                             |                           | TOOLED, COLOR UNAVAILABLE |
| 31402-3500              | 31402-3510           |                 |               |       | B                         |                      |                 | BLACK         |                     |                          |                             |                           | TOOLED                    |
| 31402-3600              | 31402-3610           |                 |               |       | C                         |                      |                 | BLACK         |                     |                          |                             |                           | TOOLED                    |
| 31402-3700              | 31402-3710           |                 |               |       | D                         |                      |                 | BLACK         |                     |                          |                             |                           | TOOLED                    |
| 31403-3000              | 31403-3010           |                 |               |       | D                         |                      |                 | DK. GRAY      |                     |                          |                             |                           | TOOLED                    |
| 31403-3100              | 31403-3110           |                 |               |       | A                         |                      |                 | BLACK         |                     |                          |                             |                           | TOOLED                    |
| 31403-3200              | 31403-3210           |                 |               |       | B                         |                      |                 | GRAY          |                     |                          |                             |                           | TOOLED                    |
| 31403-3300              | 31403-3310           |                 |               |       | C                         |                      |                 | BROWN         |                     |                          |                             |                           | TOOLED, COLOR UNAVAILABLE |
| 31403-3400              | 31403-3410           |                 |               |       | D                         |                      |                 | GREEN         |                     |                          |                             |                           | TOOLED, COLOR UNAVAILABLE |
| 31403-3500              | 31403-3510           | B               |               |       | BLACK                     |                      |                 | TOOLED        |                     |                          |                             |                           |                           |
| 31403-3600              | 31403-3610           | C               |               |       | BLACK                     |                      |                 | TOOLED        |                     |                          |                             |                           |                           |
| 31403-3700              | 31403-3710           | D               |               |       | BLACK                     |                      |                 | TOOLED        |                     |                          |                             |                           |                           |
| 31403-3800              | 31403-3810           | C               |               |       | NATURAL                   |                      |                 | TOOLED        |                     |                          |                             |                           |                           |
| 31404-3100              | 31404-3110           | A               |               |       | BLACK                     |                      |                 | TOOLED        |                     |                          |                             |                           |                           |
| 31404-3200              | 31404-3210           | B               |               |       | GRAY                      |                      |                 | TOOLED        |                     |                          |                             |                           |                           |
| 31404-3300              | 31404-3310           | C               |               | BROWN | TOOLED, COLOR UNAVAILABLE |                      |                 |               |                     |                          |                             |                           |                           |
| 31404-3400              | 31404-3410           | D               |               | GREEN | TOOLED, COLOR UNAVAILABLE |                      |                 |               |                     |                          |                             |                           |                           |
| 31404-3500              | 31404-3510           | B               |               | BLACK | TOOLED                    |                      |                 |               |                     |                          |                             |                           |                           |
| 31404-3600              | 31404-3610           | C               |               | BLACK | TOOLED                    |                      |                 |               |                     |                          |                             |                           |                           |
| 31404-3700              | 31404-3710           | D               |               | BLACK | TOOLED                    |                      |                 |               |                     |                          |                             |                           |                           |
| 31402-4100              | 31402-4110           | NO              |               | 1 X 4 | A                         | TBD                  | TBD             | BLACK         | 21.25               | (22.34)                  | TYCO OR MOLEX GET 0.64      | 064-S-004-1-Z02           | NOT TOOLED                |
| 31402-4200              | 31402-4210           |                 |               |       | B                         |                      |                 | GRAY          |                     |                          |                             |                           | NOT TOOLED                |
| 31402-4300              | 31402-4310           |                 |               |       | C                         |                      |                 | BROWN         |                     |                          |                             |                           | NOT TOOLED                |
| 31402-4400              | 31402-4410           |                 |               |       | D                         |                      |                 | GREEN         |                     |                          |                             |                           | NOT TOOLED                |
| 31402-4500              | 31402-4510           |                 |               |       | B                         |                      |                 | BLACK         |                     |                          |                             |                           | NOT TOOLED                |
| 31402-4600              | 31402-4610           |                 |               |       | C                         |                      |                 | BLACK         |                     |                          |                             |                           | NOT TOOLED                |
| 31402-4700              | 31402-4710           |                 |               |       | D                         |                      |                 | BLACK         |                     |                          |                             |                           | NOT TOOLED                |
| 31403-4100              | 31403-4110           |                 |               |       | A                         |                      |                 | BLACK         |                     |                          |                             |                           | NOT TOOLED                |
| 31403-4200              | 31403-4210           |                 |               |       | B                         |                      |                 | GRAY          |                     |                          |                             |                           | NOT TOOLED                |
| 31403-4300              | 31403-4310           |                 |               |       | C                         |                      |                 | BROWN         |                     |                          |                             |                           | NOT TOOLED                |
| 31403-4400              | 31403-4410           |                 |               |       | D                         |                      |                 | GREEN         |                     |                          |                             |                           | NOT TOOLED                |
| 31403-4500              | 31403-4510           |                 |               |       | B                         |                      |                 | BLACK         |                     |                          |                             |                           | NOT TOOLED                |
| 31403-4600              | 31403-4610           |                 |               |       | C                         |                      |                 | BLACK         |                     |                          |                             |                           | NOT TOOLED                |
| 31403-4700              | 31403-4710           |                 | D             |       | BLACK                     |                      |                 | NOT TOOLED    |                     |                          |                             |                           |                           |
| 31404-4100              | 31404-4110           |                 | A             |       | BLACK                     |                      |                 | NOT TOOLED    |                     |                          |                             |                           |                           |
| 31404-4200              | 31404-4210           |                 | B             |       | GRAY                      |                      |                 | NOT TOOLED    |                     |                          |                             |                           |                           |
| 31404-4300              | 31404-4310           |                 | C             |       | BROWN                     |                      |                 | NOT TOOLED    |                     |                          |                             |                           |                           |
| 31404-4400              | 31404-4410           |                 | D             |       | GREEN                     |                      |                 | NOT TOOLED    |                     |                          |                             |                           |                           |
| 31404-4500              | 31404-4510           |                 | B             | BLACK | NOT TOOLED                |                      |                 |               |                     |                          |                             |                           |                           |
| 31404-4600              | 31404-4610           |                 | C             | BLACK | NOT TOOLED                |                      |                 |               |                     |                          |                             |                           |                           |
| 31404-4700              | 31404-4710           |                 | D             | BLACK | NOT TOOLED                |                      |                 |               |                     |                          |                             |                           |                           |
| 31404-4800              | 31404-4810           |                 | A             | BLACK | NOT TOOLED                |                      |                 |               |                     |                          |                             |                           |                           |
| 31404-4900              | 31404-4910           |                 | B             | GRAY  | NOT TOOLED                |                      |                 |               |                     |                          |                             |                           |                           |
| 31404-5000              | 31404-5010           |                 | C             | BROWN | NOT TOOLED                |                      |                 |               |                     |                          |                             |                           |                           |
| 31404-5100              | 31404-5110           |                 | D             | GREEN | NOT TOOLED                |                      |                 |               |                     |                          |                             |                           |                           |
| 31404-5200              | 31404-5210           |                 | B             | BLACK | NOT TOOLED                |                      |                 |               |                     |                          |                             |                           |                           |
| 31404-5300              | 31404-5310           |                 | C             | BLACK | NOT TOOLED                |                      |                 |               |                     |                          |                             |                           |                           |
| 31404-5400              | 31404-5410           |                 | D             | BLACK | NOT TOOLED                |                      |                 |               |                     |                          |                             |                           |                           |

|  |                 |  |                 |       |              |   |
|--|-----------------|--|-----------------|-------|--------------|---|
| <b>REDRAW</b><br>EC NO. JAU2017-0056<br>DRAWN BY CHYD<br>CHECKED BY APPR: JENGG02<br>REV DESCRIPTION<br>2016/07/23<br>2016/07/26 | QUALITY SYMBOLS | GENERAL TOLERANCES (UNLESS SPECIFIED)                | DIMENSION STYLE | SCALE | DESIGN UNITS | THIRD ANGLE PROJECTION  |
|  | ▽=0             | 4 PLACES ± 0.13                                      | MM ONLY         | 4:1   | METRIC       | 0.64 USCAR CONNECTOR SEALED SINGLE ROW ASSEMBLY<br><b>molex</b><br>MATERIAL NO. SD-31402-211<br>DOCUMENT NO. SD-31402-211<br>SHEET NO. 6 OF 8 |
|  | ▽=0             | 3 PLACES ± 0.13                                      | mm              |       |              |   |
|  | ▽=0             | 2 PLACES ± 0.3                                       | INCH            |       |              |   |
| ▽=0  | 1 PLACE ± 0.3   |  |                 |       |              |   |
|  |                 | 0 PLACE ±  |                 |       |              |   |
|  |                 | ANGULAR ± 3°   |                 |       |              |   |
|  |                 | DRAFT WHERE APPLICABLE MUST REMAIN WITHIN DIMENSIONS |                 |       |              |   |

| PART NUMBER WITHOUT CPA | PART NUMBER WITH CPA | CLIPSLOT OPTION | ROW/ CIRCUITS | KEY*       | MATTE SEAL COLOR | PERIMETER SEAL COLOR | CONNECTOR COLOR | WIDTH DIM (A) | MIN. PASS THRU DIA. | FEMALE TERMINAL SUPPLIER  | USCAR FOOTPRINT DRAWING NO. | STATUS                    |
|-------------------------|----------------------|-----------------|---------------|------------|------------------|----------------------|-----------------|---------------|---------------------|---------------------------|-----------------------------|---------------------------|
| 31402-5100              | 31402-5110           | NO              | 1 X 5         | A          | TBD              | TBD                  | BLACK           | 23.80         | (24.28)             | TYCO OR MOLEX<br>GET 0.64 | 064-S-005-1-202             | NOT TOOLED                |
| 31402-5200              | 31402-5210           |                 |               | B          |                  |                      | GRAY            |               |                     |                           |                             | NOT TOOLED                |
| 31402-5300              | 31402-5310           |                 |               | C          |                  |                      | BROWN           |               |                     |                           |                             | NOT TOOLED                |
| 31402-5400              | 31402-5410           |                 |               | D          |                  |                      | GREEN           |               |                     |                           |                             | NOT TOOLED                |
| 31402-5500              | 31402-5510           |                 |               | B          |                  |                      | BLACK           |               |                     |                           |                             | NOT TOOLED                |
| 31402-5600              | 31402-5610           |                 |               | C          |                  |                      | BLACK           |               |                     |                           |                             | NOT TOOLED                |
| 31402-5700              | 31402-5710           |                 |               | D          |                  |                      | BLACK           |               |                     |                           |                             | NOT TOOLED                |
| 31403-5100              | 31403-5110           |                 |               | A          |                  |                      | BLACK           |               |                     |                           |                             | NOT TOOLED                |
| 31403-5200              | 31403-5210           |                 |               | B          |                  |                      | GRAY            |               |                     |                           |                             | NOT TOOLED                |
| 31403-5300              | 31403-5310           |                 |               | C          |                  |                      | BROWN           |               |                     |                           |                             | NOT TOOLED                |
| 31403-5400              | 31403-5410           |                 |               | D          |                  |                      | GREEN           |               |                     | NOT TOOLED                |                             |                           |
| 31403-5500              | 31403-5510           |                 |               | B          |                  |                      | BLACK           |               |                     | NOT TOOLED                |                             |                           |
| 31403-5600              | 31403-5610           |                 |               | C          |                  |                      | BLACK           |               |                     | NOT TOOLED                |                             |                           |
| 31403-5700              | 31403-5710           |                 |               | D          |                  |                      | BLACK           |               |                     | NOT TOOLED                |                             |                           |
| 31404-5100              | 31404-5110           |                 |               | A          |                  |                      | BLACK           |               |                     | NOT TOOLED                |                             |                           |
| 31404-5200              | 31404-5210           |                 |               | B          |                  |                      | GRAY            |               |                     | NOT TOOLED                |                             |                           |
| 31404-5300              | 31404-5310           |                 |               | C          |                  |                      | BROWN           |               |                     | NOT TOOLED                |                             |                           |
| 31404-5400              | 31404-5410           |                 |               | D          |                  |                      | GREEN           |               |                     | NOT TOOLED                |                             |                           |
| 31404-5500              | 31404-5510           |                 |               | B          |                  |                      | BLACK           |               |                     | NOT TOOLED                |                             |                           |
| 31404-5600              | 31404-5610           |                 |               | C          |                  |                      | BLACK           |               |                     | NOT TOOLED                |                             |                           |
| 31404-5700              | 31404-5710           | D               | BLACK         | NOT TOOLED |                  |                      |                 |               |                     |                           |                             |                           |
| 31402-6100              | 31402-6110           | NO              | 1 X 6         | A          | ROYAL BLUE       | LIGHT BLUE           | BLACK           | 26.33         | (26.82)             | TYCO OR MOLEX<br>GET 0.64 | 064-S-006-1-202             | TOOLED                    |
| 31402-6200              | 31402-6210           |                 |               | B          |                  |                      | GRAY            |               |                     |                           |                             | TOOLED, COLOR UNAVAILABLE |
| 31402-6300              | 31402-6310           |                 |               | C          |                  |                      | BROWN           |               |                     |                           |                             | TOOLED, COLOR UNAVAILABLE |
| 31402-6400              | 31402-6410           |                 |               | D          |                  |                      | GREEN           |               |                     |                           |                             | TOOLED                    |
| 31402-6500              | 31402-6510           |                 |               | B          |                  |                      | BLACK           |               |                     |                           |                             | TOOLED                    |
| 31402-6600              | 31402-6610           |                 |               | C          |                  |                      | BLACK           |               |                     |                           |                             | TOOLED                    |
| 31402-6700              | 31402-6710           |                 |               | D          |                  |                      | BLACK           |               |                     |                           |                             | TOOLED                    |
| 31403-6100              | 31403-6110           |                 |               | A          |                  |                      | BLACK           |               |                     |                           |                             | TOOLED                    |
| 31403-6200              | 31403-6210           |                 |               | B          |                  |                      | GRAY            |               |                     |                           |                             | TOOLED                    |
| 31403-6300              | 31403-6310           |                 |               | C          |                  |                      | BROWN           |               |                     |                           |                             | TOOLED, COLOR UNAVAILABLE |
| 31403-6400              | 31403-6410           |                 |               | D          |                  |                      | GREEN           |               |                     | TOOLED, COLOR UNAVAILABLE |                             |                           |
| 31403-6500              | 31403-6510           |                 |               | B          |                  |                      | BLACK           |               |                     | TOOLED                    |                             |                           |
| 31403-6600              | 31403-6610           |                 |               | C          |                  |                      | BLACK           |               |                     | TOOLED                    |                             |                           |
| 31403-6700              | 31403-6710           |                 |               | D          |                  |                      | BLACK           |               |                     | TOOLED                    |                             |                           |
| 31404-6100              | 31404-6110           |                 |               | A          |                  |                      | BLACK           |               |                     | TOOLED                    |                             |                           |
| 31404-6200              | 31404-6210           |                 |               | B          |                  |                      | GRAY            |               |                     | TOOLED                    |                             |                           |
| 31404-6300              | 31404-6310           |                 |               | C          |                  |                      | BROWN           |               |                     | TOOLED, COLOR UNAVAILABLE |                             |                           |
| 31404-6400              | 31404-6410           |                 |               | D          |                  |                      | GREEN           |               |                     | TOOLED, COLOR UNAVAILABLE |                             |                           |
| 31404-6500              | 31404-6510           |                 |               | B          |                  |                      | BLACK           |               |                     | TOOLED                    |                             |                           |
| 31404-6600              | 31404-6610           |                 |               | C          |                  |                      | BLACK           |               |                     | TOOLED                    |                             |                           |
| 31404-6700              | 31404-6710           | D               | BLACK         | TOOLED     |                  |                      |                 |               |                     |                           |                             |                           |
| 31404-6800              | 31404-6810           | C               | NATURAL       | TOOLED     |                  |                      |                 |               |                     |                           |                             |                           |

|  |                 |  |   |   |              |                        |
|--|-----------------|--|---|---|--------------|------------------------|
| <b>REDRAW</b><br>EC NO. UAU2017-0056<br>DRAWN BY: 2016/07/28<br>CHKD:<br>APPR.: JEN002 2016/07/28<br>REV DESCRIPTION | QUALITY SYMBOLS | GENERAL TOLERANCES (UNLESS SPECIFIED)                | DIMENSION STYLE   | SCALE   | DESIGN UNITS | THIRD ANGLE PROJECTION |
|  | ▽=0             | 4 PLACES ± mm ± INCH                                 | MM ONLY   | 4:1   | METRIC       | ☉                      |
|  | ▽=0             | 3 PLACES ± 0.13 ± 0.005                              |   |   |              |                        |
|  | ▽=0             | 1 PLACE ± 0.3 ± 0.015                                |   |   |              |                        |
|  |                 | ANGULAR ± 3 °  | DRAWN BY DATE   | TITLE   |              |                        |
|  |                 | DRAFT WHERE APPLICABLE MUST REMAIN WITHIN DIMENSIONS | RCARLSON 2003/09/25   | 0.64 USCAR CONNECTOR SEALED SINGLE ROW ASSEMBLY |              |                        |
|  |                 |  | CHECKED BY DATE   | DATE  |              |                        |
|  |                 |  | RCARLSON 2004/09/28   | 2004/09/28                                      |              |                        |
|  |                 |  | APPROVED BY DATE  | DATE  |              |                        |
|  |                 |  | VKOSHY 2010/11/22   | 2010/11/22                                      |              |                        |
|  |                 |  | MATERIAL NO.  | DOCUMENT NO.                                    | SHEET NO.    |                        |
|  |                 |  | SEE CHART   | SD-31402-211                                    | 7 OF 8       |                        |
|  |                 |  | THIS DRAWING CONTAINS INFORMATION THAT IS PROPRIETARY TO MOLEX INCORPORATED AND SHOULD NOT BE USED WITHOUT WRITTEN PERMISSION |   |              |                        |

| PART NUMBER WITHOUT CPA | PART NUMBER WITH CPA | CLIPSLOT OPTION | ROW/ CIRCUITS | KEY | MATE SEAL COLOR | PERMETER SEAL COLOR | CONNECTOR COLOR | WIDTH DIM (A) | MIN. PASS THRU DIA. | FEMALE TERMINAL SUPPLIER          | USCAR FOOTPRINT DRAWING NO. | STATUS     |
|-------------------------|----------------------|-----------------|---------------|-----|-----------------|---------------------|-----------------|---------------|---------------------|-----------------------------------|-----------------------------|------------|
| 31402-8100              | 31402-8110           | NO              | 1 X 8         | A   | TBD             | TBD                 | BLACK           | 31.25         | (31.90)             | TYCO OR MOLEX GET 0.64            | 064-S-008-1-Z02             | NOT TOOLED |
| 31402-8200              | 31402-8210           |                 |               | B   |                 |                     | GRAY            |               |                     |                                   |                             | NOT TOOLED |
| 31402-8300              | 31402-8310           |                 |               | C   |                 |                     | BROWN           |               |                     |                                   |                             | NOT TOOLED |
| 31402-8400              | 31402-8410           |                 |               | D   |                 |                     | GREEN           |               |                     |                                   |                             | NOT TOOLED |
| 31402-8500              | 31402-8510           |                 |               | B   |                 |                     | BLACK           |               |                     |                                   |                             | NOT TOOLED |
| 31402-8600              | 31402-8610           |                 |               | C   |                 |                     | BLACK           |               |                     |                                   |                             | NOT TOOLED |
| 31402-8700              | 31402-8710           |                 |               | D   |                 |                     | BLACK           |               |                     |                                   |                             | NOT TOOLED |
| 31403-8100              | 31403-8110           |                 |               | A   |                 |                     | BLACK           |               |                     |                                   |                             | NOT TOOLED |
| 31403-8200              | 31403-8210           |                 |               | B   |                 |                     | GRAY            |               |                     |                                   |                             | NOT TOOLED |
| 31403-8300              | 31403-8310           |                 |               | C   |                 |                     | BROWN           |               |                     |                                   |                             | NOT TOOLED |
| 31403-8400              | 31403-8410           |                 |               | D   |                 |                     | GREEN           |               |                     |                                   |                             | NOT TOOLED |
| 31403-8500              | 31403-8510           |                 |               | B   |                 |                     | BLACK           |               |                     |                                   |                             | NOT TOOLED |
| 31403-8600              | 31403-8610           |                 |               | C   |                 |                     | BLACK           |               |                     | NOT TOOLED                        |                             |            |
| 31403-8700              | 31403-8710           |                 |               | D   |                 |                     | BLACK           |               |                     | NOT TOOLED                        |                             |            |
| 31404-8100              | 31404-8110           |                 |               | A   |                 |                     | BLACK           |               |                     | NOT TOOLED                        |                             |            |
| 31404-8200              | 31404-8210           |                 |               | B   |                 |                     | LT. GRAY        |               |                     | INFORMATION REFER TO SD-31404-811 |                             |            |
| 31404-8300              | 31404-8310           |                 |               | C   |                 |                     | DK. GRAY        |               |                     |                                   |                             |            |
| 31404-8400              | 31404-8410           |                 |               | D   |                 |                     | TBD             |               |                     |                                   |                             |            |

ADDITIONAL CAVITY PLUG CONFIGURATIONS:

| ROW/ CIRCUITS | FEMALE TERMINAL | MOLEX P/N WITH CPA                            | MOLEX P/N WITHOUT CPA | KEY OPTION | CLIPSLOT OPTION | COLOR   | CIRCUIT NUMBER: '0' INDICATED PLUG LOCATION |   |   |   |   |   | TOTAL CIRCUITS PLUGGED | STATUS |        |        |
|---------------|-----------------|---|-----------------------|------------|-----------------|---------|---|---|---|---|---|---|------------------------|--------|--------|--------|
|               |                 |   |                       |            |                 |         | 1   | 2 | 3 | 4 | 5 | 6 |                        |        |        |        |
| 1X6           | TYCO/MOLEX GET  | 31402-6110                                    | 31402-6100            | A          | NO              | BLACK   |   |   |   |   |   |   | 0                      | TOOLED |        |        |
|               |                 | 31402-6111                                    | 31402-6101            | A          | NO              | BLACK   | 0   | 0 | 0 | 0 | 0 | 0 | 6                      | TOOLED |        |        |
|               |                 | 31402-6112                                    | 31402-6102            | A          | NO              | BLACK   | 0   | 0 | 0 |   |   |   | 2                      | TOOLED |        |        |
|               |                 | 31402-6113                                    | 31402-6103            | A          | NO              | BLACK   |   |   |   |   |   |   | 1                      | TOOLED |        |        |
|               |                 | 31402-6114                                    | 31402-6104            | A          | NO              | BLACK   | 0   | 0 | 0 | 0 |   |   | 4                      | TOOLED |        |        |
|               |                 | 31402-6115                                    | 31402-6105            | A          | NO              | BLACK   |   |   |   | 0 | 0 | 0 | 3                      | TOOLED |        |        |
|               |                 |   | 31402-6118            | 31402-6108 | A               | NO      | BLACK                                       |   |   |   |   | 0 | 1                      | TOOLED |        |        |
|               |                 |   | 31402-6150            | 31402-6140 | A               | YES     | BLACK                                       |   |   |   |   |   | 0                      | TOOLED |        |        |
|               |                 | MOLEX 0.64                                    | 31403-6110            | 31403-6100 | A               | NO      | BLACK                                       |   |   |   |   |   | 0                      | TOOLED |        |        |
|               |                 |   | 31403-6111            | 31403-6101 | A               | NO      | BLACK                                       | 0 | 0 | 0 | 0 | 0 | 0                      | 6      | TOOLED |        |
|               |                 |   | 31403-6112            | 31403-6102 | A               | NO      | BLACK                                       |   |   |   | 0 |   |                        | 1      | TOOLED |        |
|               |                 |   | 31403-6113            | 31403-6103 | A               | NO      | BLACK                                       | 0 | 0 | 0 |   |   |                        | 4      | TOOLED |        |
|               |                 |   | 31403-6114            | 31403-6104 | A               | NO      | BLACK                                       |   |   |   |   | 0 | 0                      | 2      | TOOLED |        |
|               |                 |   | 31403-6212            | 31403-6202 | B               | NO      | GRAY  |   |   |   | 0 | 0 | 0                      | 3      | TOOLED |        |
|               |                 | YAZAKI KAIZEN 0.64 TE GEN Y 0.64 JST AIT 0.64 | 31404-6110            | 31404-6100 | A               | NO      | BLACK                                       |   |   |   |   |   | 0                      | TOOLED |        |        |
|               |                 |   | 31404-6111            | 31404-6101 | A               | NO      | BLACK                                       | 0 | 0 | 0 | 0 | 0 | 0                      | 6      | TOOLED |        |
|               |                 |   | 31404-6112            | 31404-6102 | A               | NO      | BLACK                                       | 0 |   |   | 0 |   |                        | 2      | TOOLED |        |
|               |                 |   | 31404-6113            | 31404-6103 | A               | NO      | BLACK                                       | 0 |   |   |   |   |                        | 0      | 2      | TOOLED |
|               |                 |   | 31404-6116            | 31404-6106 | A               | NO      | BLACK                                       |   |   |   |   | 0 |                        | 0      | 1      | TOOLED |
|               |                 |   | 31404-6117            | 31404-6107 | A               | NO      | BLACK                                       | 0 |   | 0 |   |   | 0                      | 3      | TOOLED |        |
|               |                 |   | 31404-6118            | 31404-6108 | A               | NO      | BLACK                                       | 0 |   |   |   |   |                        | 1      | TOOLED |        |
|               |                 |   | 31404-6119            | 31404-6109 | A               | NO      | BLACK                                       |   |   |   | 0 | 0 |                        | 3      | TOOLED |        |
|               |                 |   | 31404-6132            | 31404-6122 | A               | NO      | BLACK                                       |   |   |   | 0 |   |                        | 1      | TOOLED |        |
|               |                 |   | 31404-6213            | 31404-6203 | B               | NO      | GRAY  | 0 |   |   |   |   | 0                      | 2      | TOOLED |        |
|               | 31404-6214      |   | 31404-6204            | B          | NO              | GRAY    |   |   |   |   |   | 0 | 1                      | TOOLED |        |        |
|               | 31404-6812      |   | 31404-6802            | C          | NO              | NATURAL |   |   |   | 0 | 0 | 0 | 3                      | TOOLED |        |        |
| 1X3           | TYCO/MOLEX GET  | 31402-3113                                    | 31402-3103            | A          | NO              | BLACK   |   |   |   | 0 |   |   | 1                      | TOOLED |        |        |

|   |  |   |   |                                  |   |                            |   |  |
|---|--|---|---|----------------------------------|---|----------------------------|---|--|
| <b>REDRAW</b><br>EC NO. UAU2017-0056<br>DRAWN BY M<br>CHKD:<br>APPR: JDENG02<br>REV DESCRIPTION<br>2016/07/28 | QUALITY SYMBOLS<br>∇=0<br>∇=0<br>∇=0                 | GENERAL TOLERANCES (UNLESS SPECIFIED)<br>mm INCH<br>4 PLACES ± --- ± ---<br>3 PLACES ± --- ± ---<br>2 PLACES ± 0.13 ± ---<br>1 PLACE ± 0.3 ± ---<br>0 PLACE ± ± | DIMENSION STYLE<br><b>MM ONLY</b>           | SCALE<br><b>4:1</b>              | DESIGN UNITS<br><b>METRIC</b>   | THIRD ANGLE PROJECTION<br> | TITLE<br><b>0.64 USCAR CONNECTOR SEALED SINGLE ROW ASSEMBLY</b> |  |
|   | DRAWN BY<br>RCARLSON<br>DATE<br>2003/09/25           | CHECKED BY<br>RCARLSON<br>DATE<br>2004/09/28  | APPROVED BY<br>VKOSHY<br>DATE<br>2010/11/22 | MATERIAL NO.<br><b>SEE CHART</b> | DOCUMENT NO.<br>SD-31402-211  | SHEET NO.<br>8 OF 8        |   |  |
|   | DRAFT WHERE APPLICABLE MUST REMAIN WITHIN DIMENSIONS |   | ANGULAR ± 3 °                               |                                  | THIS DRAWING CONTAINS INFORMATION THAT IS PROPRIETARY TO MOLEX INCORPORATED AND SHOULD NOT BE USED WITHOUT WRITTEN PERMISSION |                            |   |  |
|   |  |   |   |                                  |   |                            |   |  |