

NOTES:

- CARD SLOT ACCEPTS $.050 \pm .004 / (1.27 \pm 0.10)$ MODULE THICKNESS. (MEASURED OVER P.C. PADS).
- RECOMMENDED PCB THICKNESS: $.062 \pm .007 / (1.57 \pm 0.18)$
- REFER TO PRODUCT SPEC PS-71243-9999 FOR PERFORMANCE SPECIFICATIONS.
- PRODUCT IS PACKAGED IN TRAYS.
- RECOMMENDED MODULE LAYOUT SHALL BE PER JEDEC MO-161.
- RECOMMENDED PLATING ON MODULE PADS: 30 MICROINCH/(0.76 MICROMETER) MINIMUM HARD GOLD (Au) OVER 79 MICROINCH/(2.0 MICROMETER) MINIMUM NICKEL (Ni).
- SEE CHART FOR FORK/HOLE PRESENCE AND PLATING OPTION.
- PRODUCT WILL HAVE DATE CODE STAMPED ON SIDE OF HOUSING.

MATERIALS:

HOUSING - GLASS FILLED LIQUID CRYSTAL POLYMER (LCP), UL 94V-0, COLOR: BLACK.
 TERMINAL - PHOSPHOR BRONZE
 LATCHES - GLASS FILLED HIGH TEMPERATURE NYLON, UL 94V-0, COLOR: IVORY.
 FORKLOCKS - STAINLESS STEEL

PLATING:

CONTACT AREA: OPTION A: GOLD (Au) FLASH; THICKNESS=2-10 MICROINCH/(0.05-0.25 MICROMETER), OVER PALLADIUM-NICKEL (Pd-Ni); THICKNESS=30 MICROINCH/(0.76 MICROMETER) MINIMUM.
 OPTION B: GOLD (Au) FLASH; THICKNESS=2-10 MICROINCH/(0.05-0.25 MICROMETER), OVER PALLADIUM-NICKEL (Pd-Ni); THICKNESS=20 MICROINCH/(0.51 MICROMETER) MINIMUM.

SOLDER TAILS:

TIN (Sn); THICKNESS=150 MICROINCH/(3.81 MICROMETER) MINIMUM.

UNDERPLATE:

NICKEL (Ni) OVER ENTIRE CONTACT.

FORKLOCKS:

NONE

NOTE FOR LEAD FREE CONVERSION:

THE PRIMARY SHIPPING CARTON WILL BE LABELED "COMPLIANT TO ROHS DIRECTIVE 2002/95/EC AND ELV ANNEX II OF DIRECTIVE 2000/53/EC". CARTONS WITHOUT THIS LABEL MAY CONTAIN PRODUCT WITH LEAD.

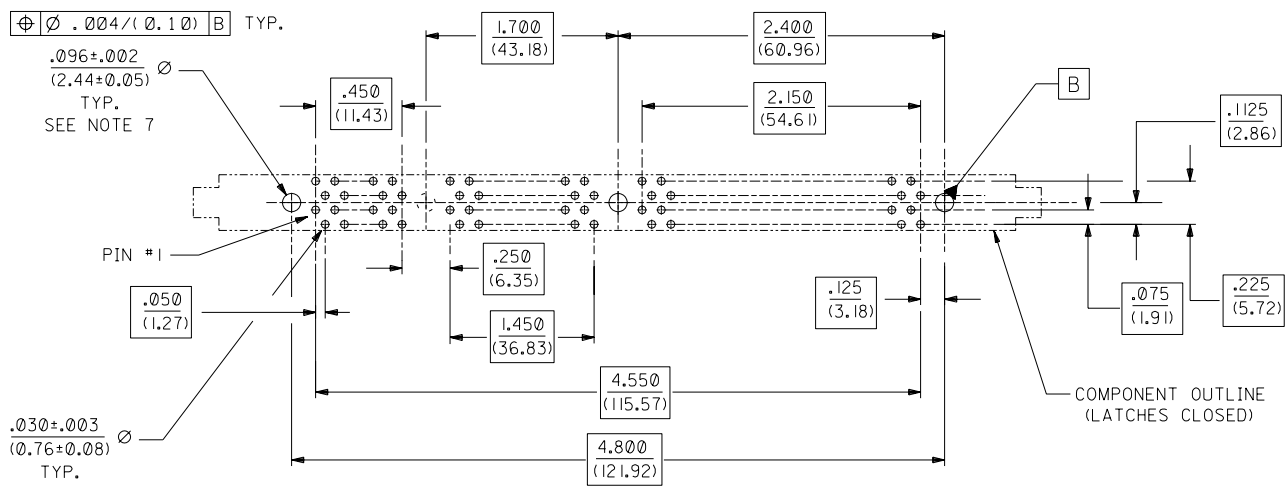
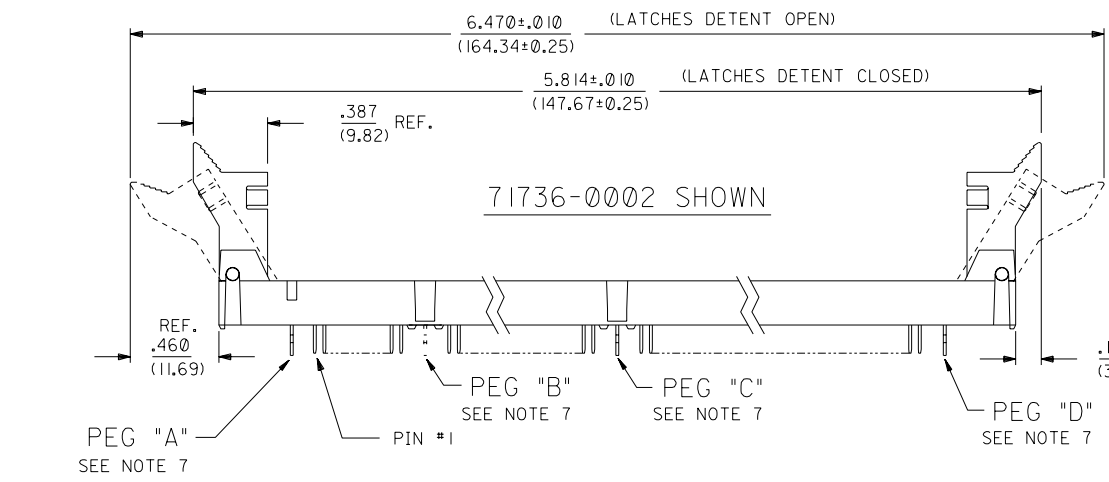
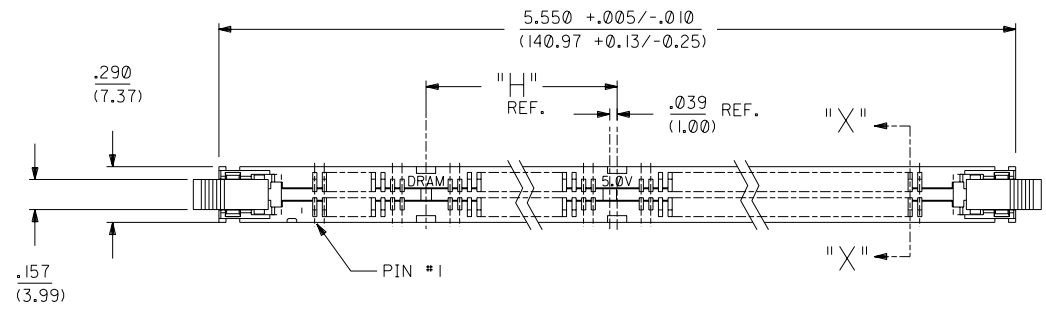

RECOMMENDED P.C. BOARD HOLE PATTERN (CONNECTOR SIDE)

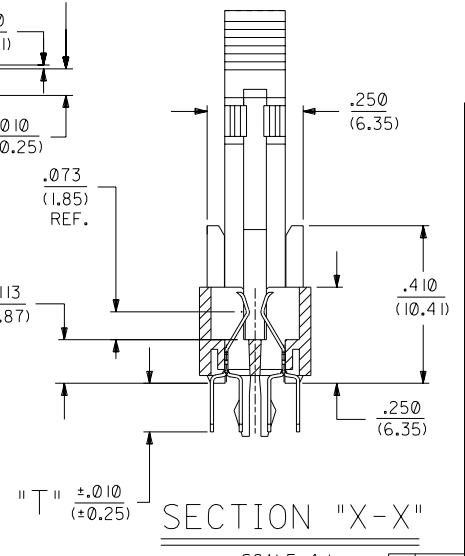
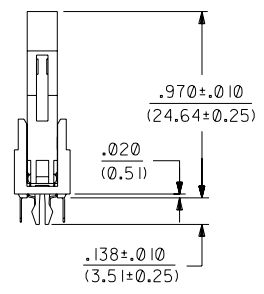

E1	ADD LEAD FREE NOTE ECN# UCPR2004-1132 DMORGAN 04/03/09
E	CHG Sn-Pb THICKNESS ECN# UDI1999-0454 DMORGAN 99/08/09
D3	REVISED PER ECR# U71162 97-4-15 LAURX
D2	REVISED PER ECR# U70731 97-1-8 LAURX
D1	REVISED PER ECR# U70361 96-10-9 LAURX
D	REVISED PER ECR# U61133 96-9-26 LAURX
C	REVISED PER ECR# U61450 5-28-96 JCL
B	REVISED PER ECR# U61050 2-28-96 JCL
A	INITIAL RELEASE PER ECR# U60675 12-6-95 JCL

DIMENSIONS SHOWN (METRIC) INCH UNLESS OTHERWISE SPECIFIED TOLERANCES: ANGULAR ± 1/2°		REVISIONS	
3 PLATE ± .005	---	3	D3
2 PLATE ± ---	± 0.13	2	D3
1 PLATE ---	± 0.25	1	E1
DRAFT WHERE APPLICABLE MUST REMAIN WITHIN DIMENSIONS		MFG, SH.	REV.
DRWG. NO. SDA-71736-0		LTR.	REV. 1
FILE NAME: ST173601.DGN		DATE	12/06/95
SCALE: 2:1		U.S.A.	1 OF 3
APPROV. BY: DCB		THIS DRAWING CONTAINS INFORMATION THAT IS PROPRIETARY TO MOLEX INC. AND SHOULD NOT BE USED WITHOUT WRITTEN PERMISSION.	

X=N.T.	ITEM NO. 71736-0***	CKT SIZE	DESCRIPTION	COLOR	FUNCTION KEY	VOLTAGE KEY	PEG "A"	PEG "B"	PEG "C"	PEG "D"	DIM. 'H'	DIM. 'T'	CONTACT AREA PLATING
	-0001	168	3.3 VOLT STD DRAM	BLACK	CENTER	CENTER	FORK	NONE	FORK	FORK	1.700 (43.18)	.127 (3.23)	OPTION A
	-0002	168	5.0 VOLT STD DRAM	BLACK	CENTER	OFFSET LEFT	FORK	NONE	FORK	FORK	1.700 (43.18)	.127 (3.23)	OPTION A
	-0011	168	3.3 VOLT UNBUFFERED	BLACK	OFFSET RIGHT	CENTER	FORK	NONE	FORK	FORK	1.661 (42.19)	.127 (3.23)	OPTION A
	-0005	168	5.0 VOLT UNBUFFERED	BLACK	OFFSET RIGHT	OFFSET LEFT	FORK	NONE	FORK	FORK	1.661 (42.19)	.127 (3.23)	OPTION A
	-0006	168	3.3 VOLT SYNCHRONOUS	BLACK	OFFSET LEFT	CENTER	FORK	NONE	FORK	FORK	1.739 (44.17)	.127 (3.23)	OPTION A
	-0007	168	5.0 VOLT SYNCHRONOUS	BLACK	OFFSET LEFT	OFFSET LEFT	FORK	NONE	FORK	FORK	1.739 (44.17)	.127 (3.23)	OPTION A

- NOTES:
1. STRAIGHTNESS OF MODULE APPLIES TO THE AREA FROM THE BOTTOM OF THE CARD UP .157/(4.00).
 2. IF TIE BARS ARE ATTACHED TO PADS, THE TIE BAR SHOULD BE ON AN INTERNAL LAYER, SO THAT THE REMNANT CANNOT CAUSE DAMAGE TO THE CONTACTS.

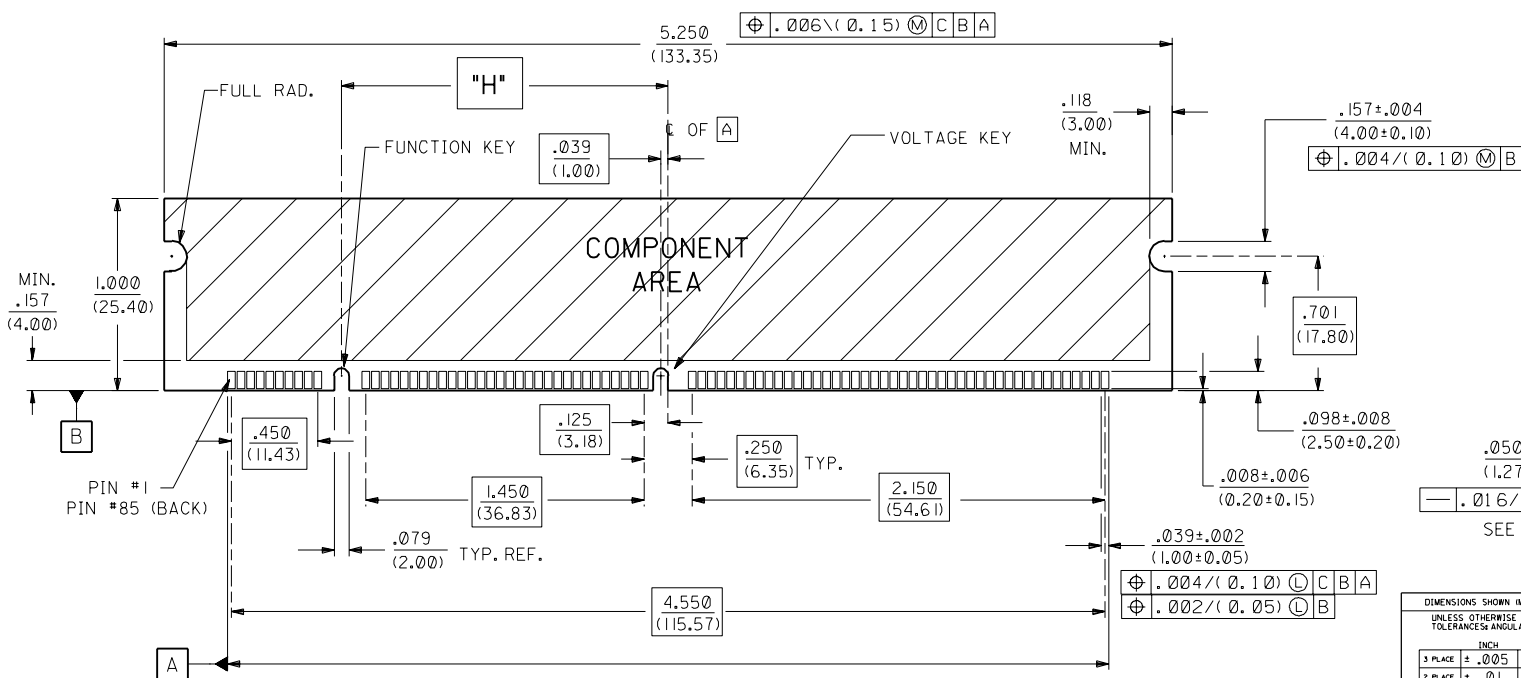
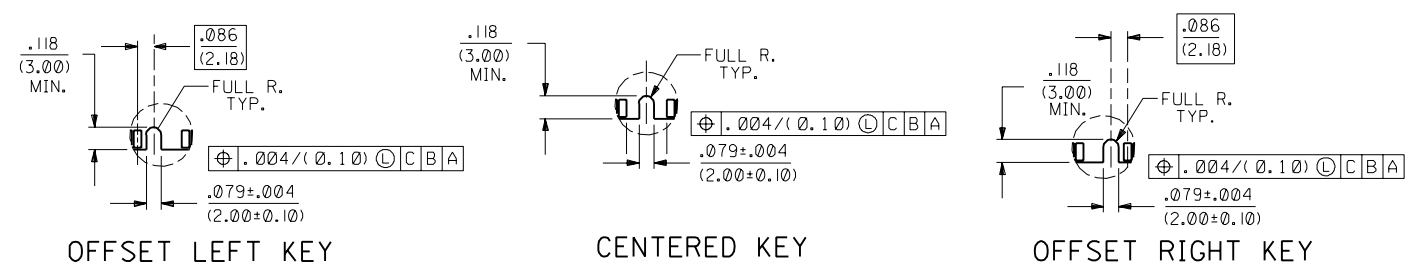

D3	SEE SHEET I
D2	SEE SHEET I
D1	SEE SHEET I
D	SEE SHEET I
C	SEE SHEET I
B	SEE SHEET I
A	SEE SHEET I

DIMENSIONS SHOWN (METRIC) INCH		UNLESS OTHERWISE SPECIFIED TOLERANCES ANGULAR ± 1/2°	
3 PLACE	± .005	---	---
2 PLACE	± .01	± 0.13	---
1 PLACE	---	± 0.25	---
DRAFT WHERE APPLICABLE MUST REMAIN WITHIN DIMENSIONS			
DRWG. NO.	FILE NAME	SHEET NO.	DATE
71736-0	S7173602	2	12/06/95
DRWG. BY	CHK'D. BY	TITLE	
JCL	DCB	.050 PITCH MULTI-KEY DIMM TALL LATCH RAM ASSEMBLY W/FORKLOCKS - SALES DWG	
SCALE		REVISE ONLY ON CAD SYSTEM	
2: 1		MFG. SH. REV. LTR. REVISIONS	
		MOLEX INCORPORATED U.S.A. 60532	
		PART NO. SDA-71736-0***	
		THIS DRAWING CONTAINS INFORMATION THAT IS PROPRIETARY TO MOLEX INC. AND SHOULD NOT BE USED WITHOUT WRITTEN PERMISSION.	

RECOMMENDED MODULE LAYOUT
168 CKT 5.0V DRAM SHOWN

71736

SEE CHART