

91577-*326	26	35.53	31.75	14	98	7
91577-*324	24	32.99	29.21	15	105	↑
91577-*322	22	30.45	26.67	16	112	
91577-*320	20	27.91	24.13	18	126	
91577-*318	18	25.37	21.59	20	140	
91577-*316	16	22.83	19.05	23	161	
91577-*314	14	20.29	16.51	26	182	
91577-*312	12	17.75	13.97	30	210	
91577-*310	10	15.21	11.43	34	238	
91577-*308	8	12.67	8.89	42	294	
91577-*306	6	10.13	6.35	54	378	
91577-*304	4	7.59	3.81	70	490	7
PART No.	CCT SIZE	DIM "A"	DIM "B"	TUBE QTY	STACK QTY	TUBES PER STACK

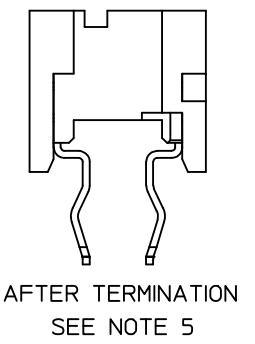
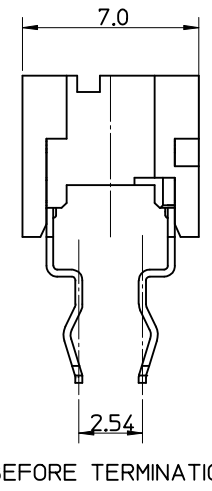
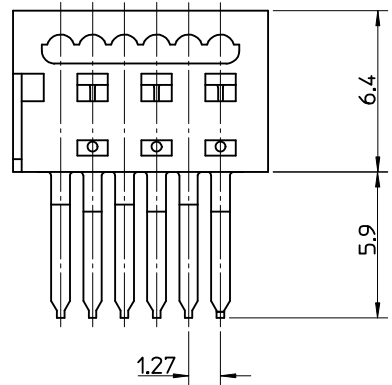
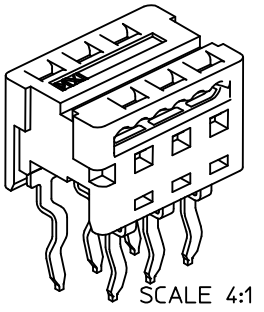
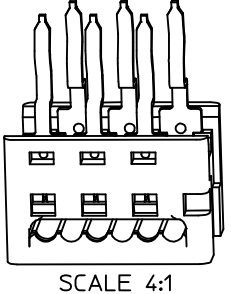
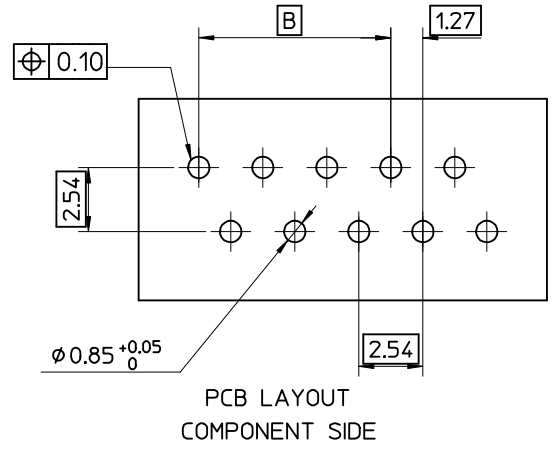
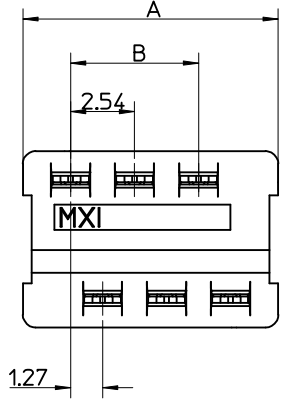

- NOTES:
- MATERIAL: HOUSING - POLYESTER RATED UL 94V-0, COLOUR WHITE  
IDT CONTACT: PHOSPHOR BRONZE ALLOY 0.28mm REF THICK
  - PLATING: 2-4  $\mu$ m. TIN
  - PACKAGING:TUBE (2 OPTIONS; INDIVIDUAL OR STACKED TUBES, SEE SHT2)
  - SEE PRODUCT SPECIFICATION PS-99020-0011
  - WIRE TERMINATION SPECIFICATION ES-99033-0002

91577-\*3\*\*  
 04 TO 26 = CCT SIZE  
 1=INDIVIDUAL TUBED ASSY  
 2=STACKED TUBE ASSY

UPDATED COLOUR EC NO: IPG2015-1317 DRWN: JKEARNS 2015/01/22 CHKD: DBYRNES 2015/01/22 APPR: ST.GRIFFIN 2015/05/19	QUALITY SYMBOLS	GENERAL TOLERANCES (UNLESS SPECIFIED)	SCALE 5:1	DESIGN UNITS METRIC	THIRD ANGLE PROJECTION	REVISE ON CAD ONLY
	-0 C-0	mm INCH 4 PLACES ± --- ± --- 3 PLACES ± --- ± --- 2 PLACES ± 0.25 ± --- 1 PLACE ± 0.25 ± --- ANGULAR ± 2 °	DIMENSION STYLE MM ONLY	TITLE 1.27MM PF LOPRO IDT ALT STAG B-IN CONN		
T REV	DESCRIPTION	DRAFT WHERE APPLICABLE MUST REMAIN WITHIN DIMENSIONS	DRAWN BY DATE KDELANEY 2001/11/03	MOLEX INCORPORATED		
			CHECKED BY DATE EFOLAN 2001/11/05	MATERIAL NO. SEE CHART DOCUMENT NO. SD-91577-001 SHEET NO. 1 OF 2		
THIS DRAWING CONTAINS INFORMATION THAT IS PROPRIETARY TO MOLEX INCORPORATED AND SHOULD NOT BE USED WITHOUT WRITTEN PERMISSION			A3			

10 9 8 7 6 5 4 3 2 1

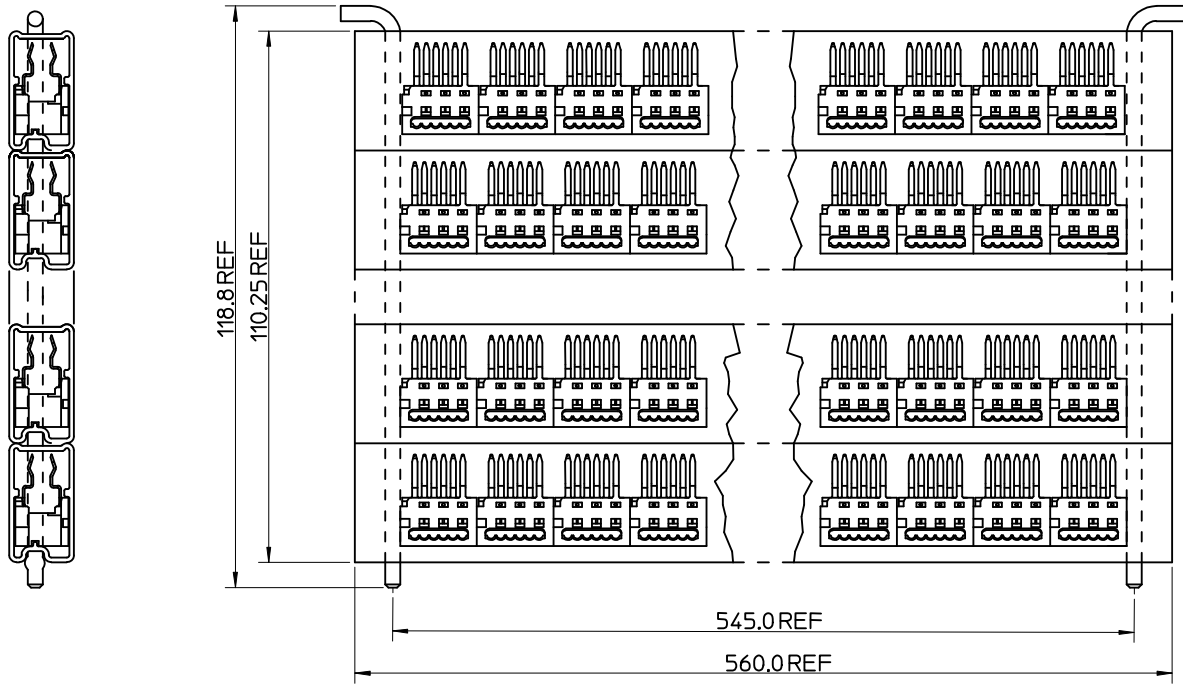

91577-23\*\* STACKED TUBE ASSY

SEE SHEET 1 EC NO: IPG2015-1317 DRWN: JKEARNS 2015/01/22 CHKD: DBYRNES 2015/01/22 APPR: STGRIFFIN 2015/05/19	QUALITY SYMBOLS ▽ - 0 ∇ - 0	GENERAL TOLERANCES (UNLESS SPECIFIED)		SCALE 1:1	DESIGN UNITS METRIC	THIRD ANGLE PROJECTION	REVISE ON CAD ONLY		
		4 PLACES ± --- ± --- 3 PLACES ± --- ± --- 2 PLACES ± 0.25 ± --- 1 PLACE ± 0.25 ± ---	mm INCH	DIMENSION STYLE MM ONLY		TITLE 1.27MM PF LOPRO IDT ALT STAG B-IN CONN			
		ANGULAR ± 2 °		DRAWN BY DATE KDELANEY 2001/11/03	CHECKED BY DATE EFOLAN 2001/11/05		MOLEX MOLEX INCORPORATED		
		DRAFT WHERE APPLICABLE MUST REMAIN WITHIN DIMENSIONS		APPROVED BY DATE MWILHITE 2001/11/05	MATERIAL NO. SEE SHEET 1	DOCUMENT NO. SD-91577-001	SHEET NO. 2 OF 2	THIS DRAWING CONTAINS INFORMATION THAT IS PROPRIETARY TO MOLEX INCORPORATED AND SHOULD NOT BE USED WITHOUT WRITTEN PERMISSION	

9 8 7 6 5 4 3 2 1