

DDS Series Micro Mini Thru-hole Detect Switches



Features/Benefits

- Vertical or horizontal actuation
- 2mm overtravel—Ideal for detector applications
- Low actuations force (less than 40 grams)
- RoHS compliant and compatible

Typical Applications

- Detect the presence of a mechanical device
- Medical devices
- Consumer electronic devices

Specifications

CONTACT RATING: 0.1A @ 30 VDC.
 MECHANICAL & ELECTRICAL LIFE: 50,000 cycles.
 CONTACT RESISTANCE: 150 m Ω max. initial.
 INSULATION RESISTANCE: 100 M Ω min. @ 100 VDC.
 OPERATING TEMPERATURE: -20°C to +70°C.
 DIELECTRIC STRENGTH: 100 volts AC @ 60 Hz.
 PACKAGING: Bulk.

Materials

HOUSING: P.P.S.
 ACTUATOR: PA66
 MOVABLE CONTACT: Tin bronze, silver plated.

NOTE: Specifications and materials listed above are for switches with standard options. For information on specific and custom switches, consult Customer Service Center.

How To Order

Complete part numbers for DDS Series Switches are shown below.



DDS001
SPST

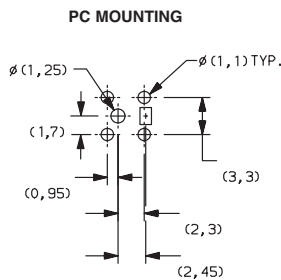
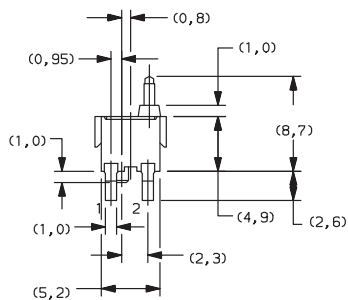
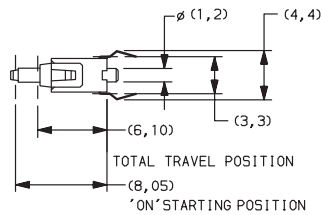
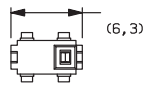

PART NUMBER	DESCRIPTION	SCHEMATIC
DDS001	Vertical Actuator	 SPST N.O.



Detect

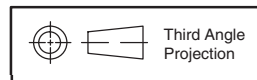

Dimensions are shown: mm
 Specifications and dimensions subject to change

DDS Series Micro Mini Thru-hole Detect Switches



PART NUMBER	DESCRIPTION	SCHEMATIC
DDS002	Right angle, actuator right	 SPST N.O.

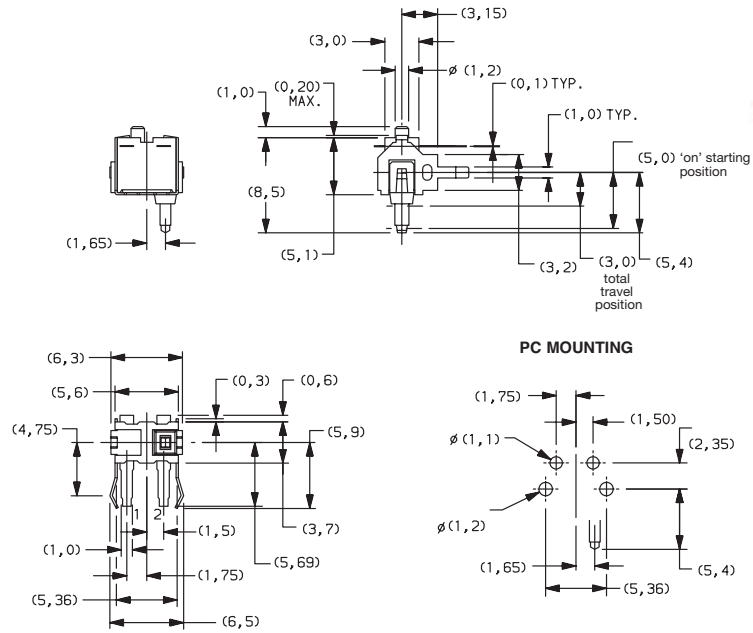

**DDS002
SPST**

PART NUMBER	DESCRIPTION	SCHEMATIC
DDS003	Right angle, actuator left	 SPST N.O.

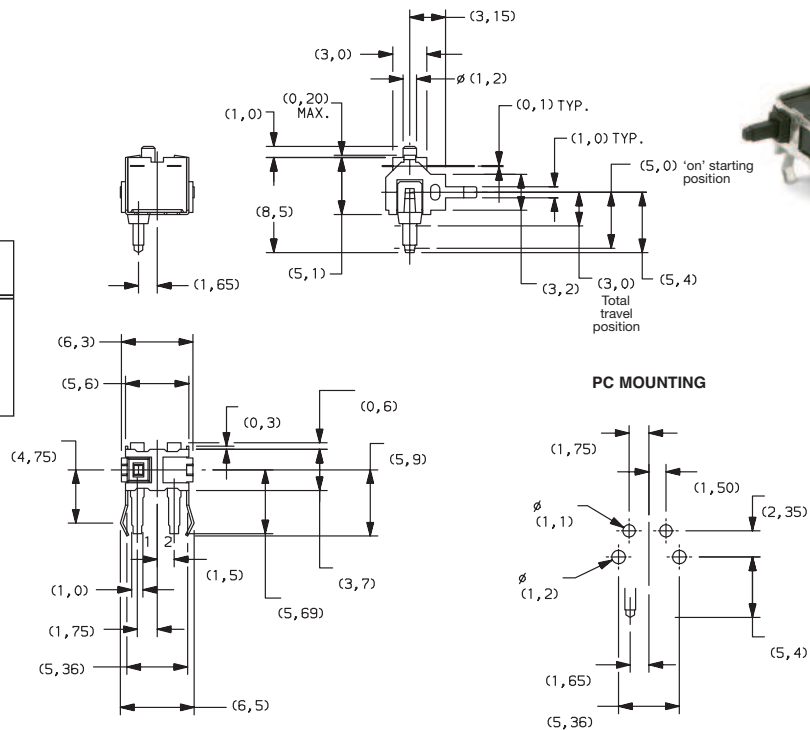

Detect

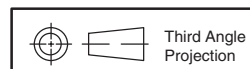

Dimensions are shown: mm
Specifications and dimensions subject to change