

# ZMSM Series with Mounting Hole Subminiature Snap-acting Switches (IP65)

## Features/Benefits

- Reliable snap-acting mechanism
- Long electrical and mechanical life
- Various PCB terminals and actuators
- RoHS compatible
- IP67 with potted wires only

## Typical Applications

- Communication devices
- Testing equipment
- Security/Alarm systems

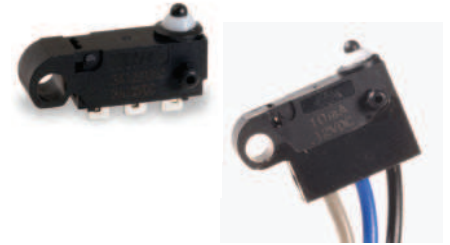

UL61058-1  US

## Specifications

CONTACT RATING: 3A@ 125 V AC/ 3A@ 12 V DC, 0.01 A@ 12 V DC.

ELECTRICAL LIFE: 100,000 cycles @ 0.01 A, 12 V DC / 100,000 cycles @ 3A, 12 V DC, 6,000 cycles @ 3A, 125 VAC

INSULATION RESISTANCE: 100 M ohm min.

DIELECTRIC STRENGTH: 500 Vrms.

OPERATING TEMPERATURE: see chart below.

OPERATING FORCE: 130 grams.

\* Low Level=conditions where no arcing occurs during switching, i.e., 0.4 VA max. @ 20 V AC or DC max.

## Materials

CASE: Nylon

COVER/ACTUATOR: PBT

MOVABLE CONTACTS: 3 Amp silver, 0.01A gold

STATIONARY CONTACTS: 3 Amp silver, 0.01A gold

TERMINALS: Brass, Pre-plated with silver

LEVER: Stainless steel

**NOTE:** Specifications and materials listed above are for switches with standard options. For information on specific and custom switches, consult Customer Service Center.

## Build-A-Switch

To order, simply select desired option from each category and place in the appropriate box. Available options are shown and described on pages J-62 through J-64. For additional options not shown in catalog, consult Customer Service Center.

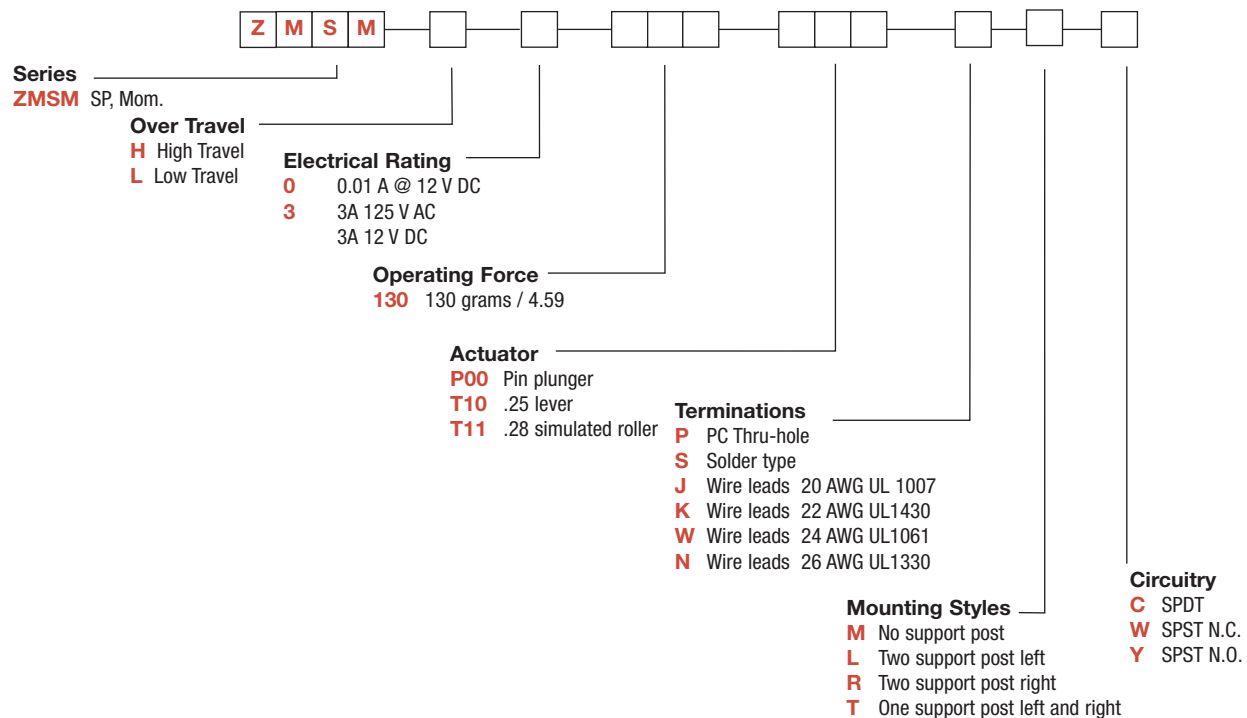

Dimensions are shown: mm  
 Specifications and dimensions subject to change



Snap-acting

# ZMSM Series with Mounting Hole Subminiature Snap-acting Switches (IP65)

## SERIES

**ZMSMH** HIGH OVER TRAVEL

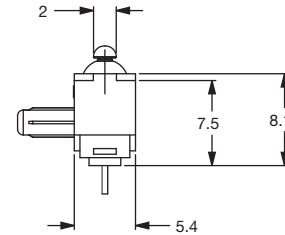
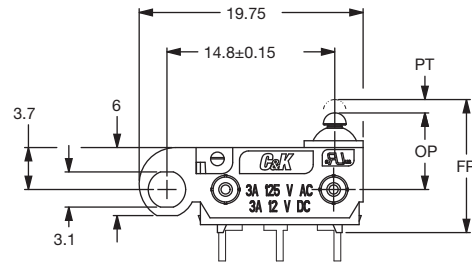

**ZMSML** LOW OVER TRAVEL

MODEL SHOWN: ZMSMHXXXP00PLC

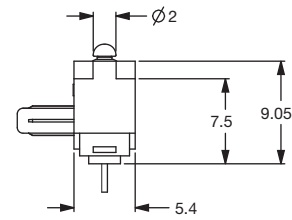
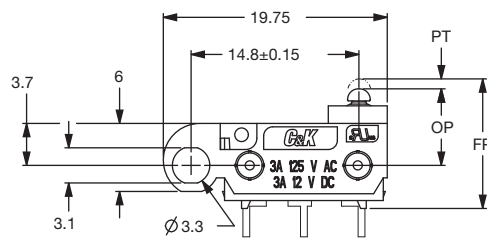

MODEL SHOWN: ZMSMLXXXP00PLC



Snap-acting

## ELECTRICAL RATING

OPTION CODE	RoHS COMPLIANT*	RoHS COMPATIBLE*	CONTACT MATERIAL		ELECTRICAL RATING
			MOVABLE CONTACT	STATIONARY CONTACT	
<b>0</b>	Yes	Yes	Gold alloy		0.01 A @ 12 V DC
<b>3</b>	Yes	Yes	Silver alloy		3 AMPS @ 125 V AC 3 AMPS @ 12 V DC

Model **C&K** with option "S" (solder type) only.  
Consult Customer Service center for availability and delivery of nonstandard ratings.

## OPERATING FORCE

OPTION CODE	BASIC SWITCH OPERATING FORCE (OZ./GRAMS)
<b>130</b>	130 4.59



Dimensions are shown: mm  
Specifications and dimensions subject to change



# ZMSM Series with Mounting Hole Subminiature Snap-acting Switches (IP65)

## ACTUATOR

**P00** PIN PLUNGER (IP65)

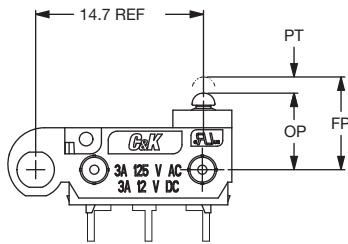

MODEL SHOWN: ZMSMLXXXXP00PLC

**T10** .25 LEVER (IP65)

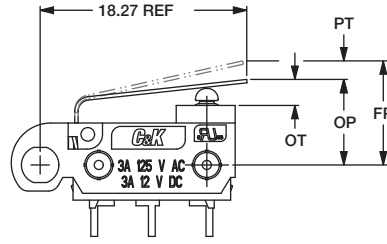

MODEL SHOWN: ZMSMLXXXT10PLC

**T11** LEVER (IP65)

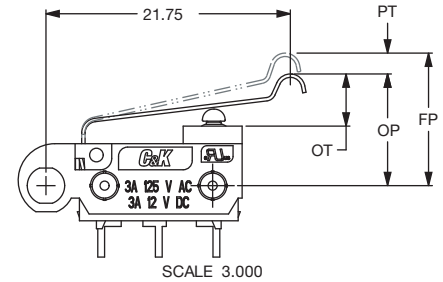

MODEL SHOWN: ZMSMLXXXT11PLC

### SWITCH CHARACTERISTICS

Actuator code	Maximum Operate Force (grams/oz.)	Minimum Release Force (grams/oz.)	Free Position Max (mm)	Maximum Pre-travel (mm)	Operate Position (mm)	Maximum Differential (mm)	Low Overtravel min. (mm)	High Overtravel min. (mm)
<b>P00</b>	130 4.59	13 0.45	7.35	0.8	6.75 ± 0.3	0.3	0.8	1.75
<b>T10</b>	195 6.88	55 1.93	10.70	3.85	7.40 ± 0.8	0.5	1.35	2.3
<b>T11</b>	160 5.64	45 1.58	13.80	4.8	9.90 ± 0.8	0.7	1.65	2.6

## TERMINATIONS

**P** PC THRU-HOLE (IP65)

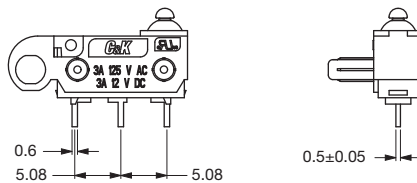

MODEL SHOWN: ZMSMHXXXXP00PLC

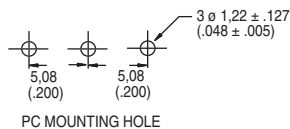

PC MOUNTING HOLE

**S** SOLDER TYPE (IP65)

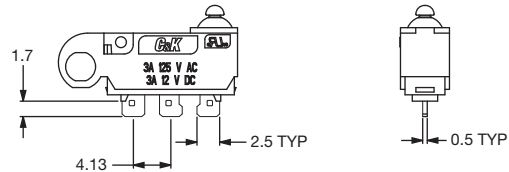

MODEL SHOWN: ZMSMHXXXXP00SMC

**J** WIRE LEADS BOTTOM (IP67)

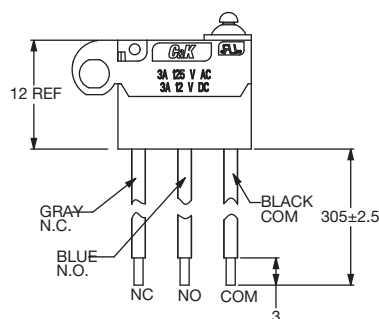

Standard Wire: 20 AWG UL 1007

Available options - must specify

22AWG UL1430

24AWG UL1061

26AWG UL1330



Third Angle  
Projection

Dimensions are shown: mm  
Specifications and dimensions subject to change

**C&K**

# ZMSM Series with Mounting Hole Subminiature Snap-acting Switches (IP65)

## MOUNTING STYLES

**M** NO SUPPORT POSTS

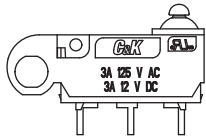
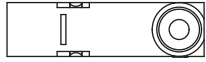

MODEL SHOWN:  
ZMSMHXXXXP00PMC

**L** TWO SUPPORT POSTS LEFT

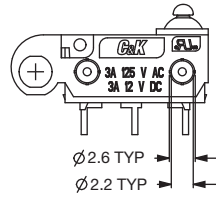
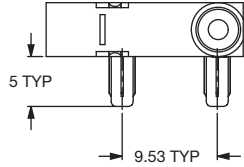

POSTS LEFT  
MODEL SHOWN:  
ZMSMHXXXXP00PLC

**R** TWO SUPPORT POSTS RIGHT

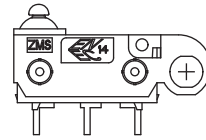
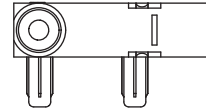

POSTS RIGHT  
MODEL SHOWN:  
ZMSMHXXXXP00PRC

**T** ONE SUPPORT POST LEFT & RIGHT

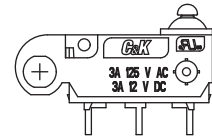
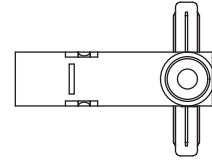

LEFT & RIGHT  
MODEL SHOWN:  
ZMSMHXXXXP00PTC



Snap-acting

## CIRCUITRY

- C** SPDT (Single Pole, Double Throw)
- W** SPST, NC (Single Pole, Single Throw, Normally Closed)
- Y** SPST, NO (Single Pole, Single Throw, Normally Open)

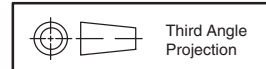

Dimensions are shown: mm  
Specifications and dimensions subject to change

