

# PTS635 Series 3,5 mm Tact Switches

## Features/Benefits

- Compact size 6 x 3.5 mm
- Variety of switch heights
- Choice of actuation force
- RoHS compliant and compatible

## Typical Applications

- Consumer products
- Instrumentation
- Computer products
- Industrial



B

Tactile Switches

## Specification

FUNCTION: Momentary action  
CONTACT ARRANGEMENT: SPST, N.O.  
TERMINALS: PC pins

## Mechanical

ACTUATION FORCE: PTS635L models: 130 grams.  
PTS635H models: 200 grams.  
LIFE EXPECTANCY: 20,000 operations.

## Electrical

CONTACT RATING: 50 mA @ 12 V DC.  
DIELECTRIC STRENGTH: 250 V AC min.  
CONTACT RESISTANCE: 100 mΩ max. initial.  
INSULATION RESISTANCE: 10<sup>11</sup>Ω min.

## Environmental

OPERATING TEMPERATURE: -40°C to 60°C

**NOTE:** Specifications listed above are for switches with standard options.  
For information on specific and custom switches, consult Customer Service Center.

## Process

SOLDERING: Preheating to 100°C for 45 sec. max. Keep flux flush with top surface of PCB; do not apply to component side of PCB and area where terminals are located. Soldering to 255°C for 5 sec. max. Clean by brushing on solder surface. Do not clean switch with solvents.

## Materials

BASE: 6/6 nylon or glass filled polyester (PBT) (UL 94V-0).  
ACTUATOR: 6/6 nylon or polyacetal (UL 94HB).  
COVER PLATE: PTS635S and PTS635V models: Tin plated stainless steel  
DOME CONTACTS: Phosphor bronze, silver clad.  
STATIONARY CONTACTS: Brass, silver plated.  
TERMINALS: Brass, silver plated. Insert molded.

## Packaging

Bulk packaging.

## Tape & reel for:

PTS635Sx43SMTR, 1700 pcs per reel

## How To Order

Our easy build-a-switch concept allows you to mix and match options to create the switch you need. To order, select desired option from each category and place it in the appropriate box.

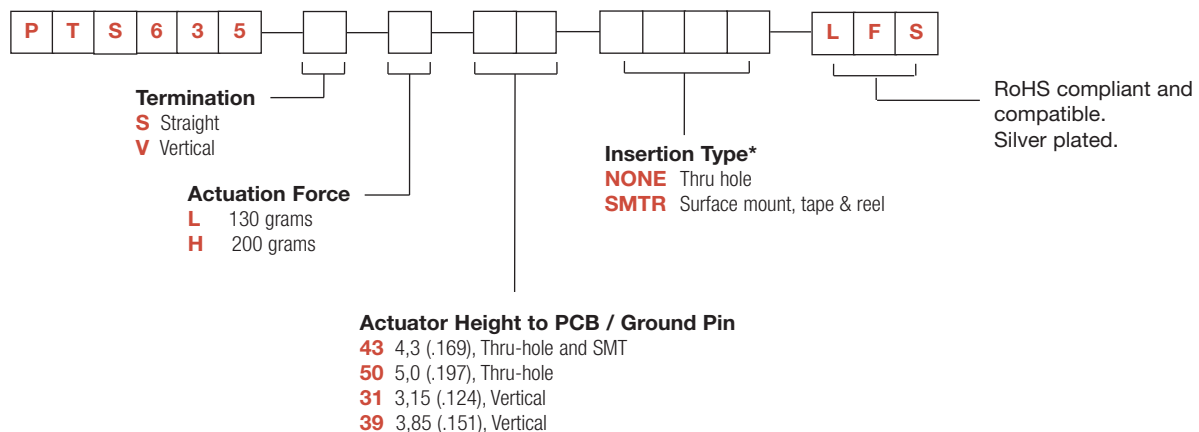

\* SMTR only available with PTS635 43 Actuator Height options.

# PTS635 Series 3,5 mm Tact Switches

SERIES

## PTS635

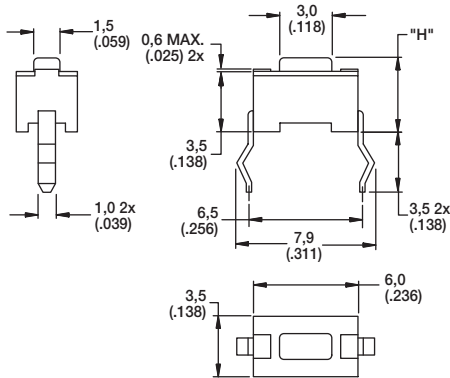

For "H" dimension please refer to chart on next page

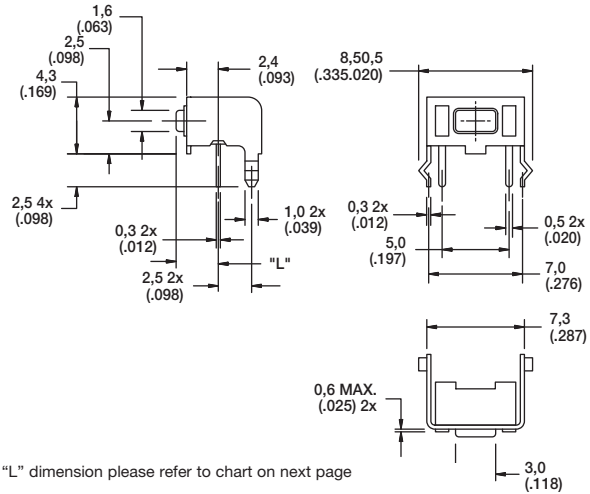

For "L" dimension please refer to chart on next page

Tactile Switches

TERMINATION

## S STRAIGHT

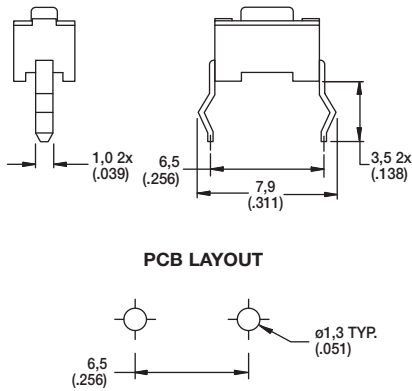

## V VERTICAL

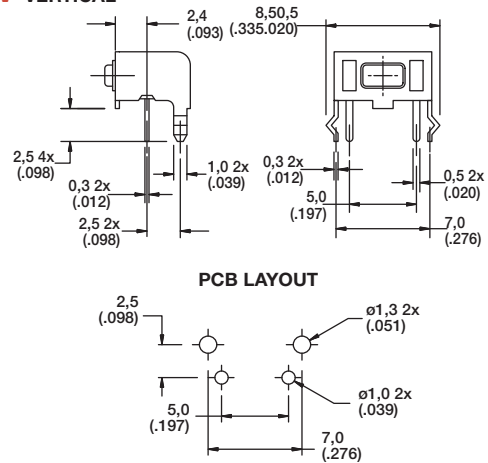

## SMT 43

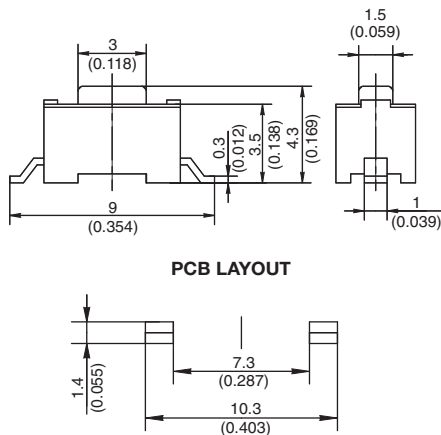

First Angle  
Projection

Dimensions are shown: mm (inches)  
Specifications and dimensions subject to change

# PTS635 Series 3,5 mm Tact Switches



## ACTUATION FORCE



OPTION CODE	FORCE
<b>L</b>	130 grams
<b>H</b>	200 grams

## ACTUATOR HEIGHT

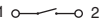

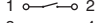
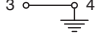
OPTION CODE	HEIGHT "H" or LENGTH "L"	TERMINATION	SCHEMATIC
<b>43</b>	4,3 (.169)	Thru-hole & SMT	1  2
<b>50</b>	5,0 (.197)	Thru-hole	1  2
<b>31</b>	3,15 (.124)	Vertical	1  2
<b>39</b>	3,85 (.151)	Vertical	3  4

## INSERTION TYPE



**SMTR** 43

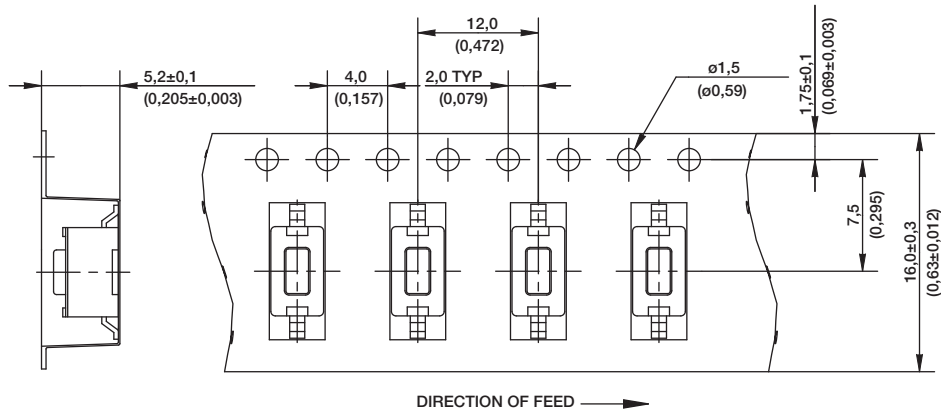

First Angle  
Projection

Dimensions are shown: mm (inches)  
Specifications and dimensions subject to change