

## Photomicrosensor (Reflective) EE-SY110

**⚠ Be sure to read *Precautions* on page 24.**

### ■ Dimensions

**Note:** All units are in millimeters unless otherwise indicated.

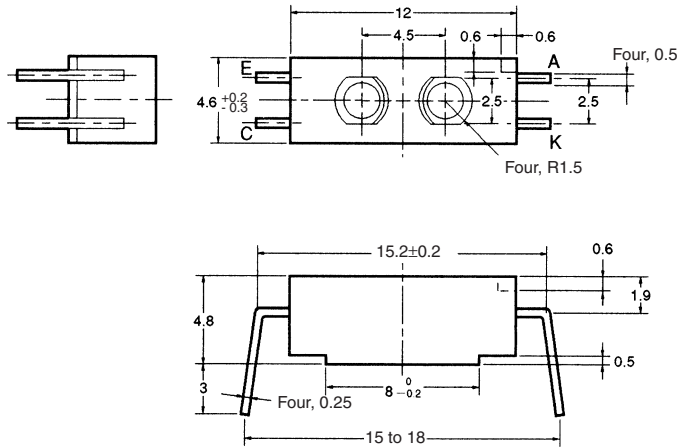

#### Internal Circuit

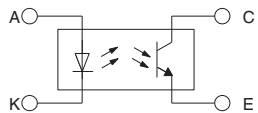

Unless otherwise specified, the tolerances are as shown below.

Dimensions	Tolerance
3 mm max.	±0.2
3 < mm ≤ 6	±0.24
6 < mm ≤ 10	±0.29
10 < mm ≤ 18	±0.35
18 < mm ≤ 30	±0.42

Terminal No.	Name
A	Anode
K	Cathode
C	Collector
E	Emitter

### ■ Features

- Compact reflective model with a molded housing.
- Recommended sensing distance = 5.0 mm

### ■ Absolute Maximum Ratings (Ta = 25°C)

Item	Symbol	Rated value
Emitter	Forward current	$I_F$ 50 mA (see note 1)
	Pulse forward current	$I_{FP}$ 1 A (see note 2)
	Reverse voltage	$V_R$ 4 V
Detector	Collector–Emitter voltage	$V_{CEO}$ 30 V
	Emitter–Collector voltage	$V_{ECO}$ ---
	Collector current	$I_C$ 20 mA
	Collector dissipation	$P_C$ 100 mW (see note 1)
Ambient temperature	Operating	$T_{opr}$ -40°C to 85°C
	Storage	$T_{stg}$ -40°C to 85°C
Soldering temperature		$T_{sol}$ 260°C (see note 3)

- Note:**
1. Refer to the temperature rating chart if the ambient temperature exceeds 25°C.
  2. The pulse width is 10  $\mu$ s maximum with a frequency of 100 Hz.
  3. Complete soldering within 10 seconds.

### ■ Electrical and Optical Characteristics (Ta = 25°C)

Item	Symbol	Value	Condition
Emitter	Forward voltage	$V_F$ 1.2 V typ., 1.5 V max.	$I_F = 30$ mA
	Reverse current	$I_R$ 0.01 $\mu$ A typ., 10 $\mu$ A max.	$V_R = 4$ V
	Peak emission wavelength	$\lambda_P$ 940 nm typ.	$I_F = 20$ mA
Detector	Light current	$I_L$ 200 $\mu$ A min., 2,000 $\mu$ A max.	$I_F = 20$ mA, $V_{CE} = 10$ V White paper with a reflection ratio of 90%, d = 5 mm (see note)
	Dark current	$I_D$ 2 nA typ., 200 nA max.	$V_{CE} = 10$ V, 0 lx
	Leakage current	$I_{LEAK}$ 2 $\mu$ A max.	$I_F = 20$ mA, $V_{CE} = 10$ V with no reflection
	Collector–Emitter saturated voltage	$V_{CE(sat)}$ ---	---
	Peak spectral sensitivity wavelength	$\lambda_P$ 850 nm typ.	$V_{CE} = 10$ V
Rising time	$t_r$ 30 $\mu$ s typ.	$V_{CC} = 5$ V, $R_L = 1$ k $\Omega$ , $I_L = 1$ mA	
Falling time	$t_f$ 30 $\mu$ s typ.	$V_{CC} = 5$ V, $R_L = 1$ k $\Omega$ , $I_L = 1$ mA	

**Note:** The letter “d” indicates the distance between the top surface of the sensor and the sensing object.

■ Engineering Data

**Forward Current vs. Collector Dissipation Temperature Rating**

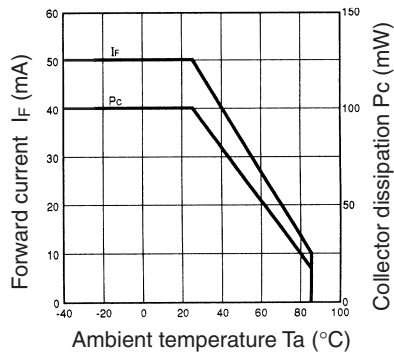

**Light Current vs. Forward Current Characteristics (Typical)**

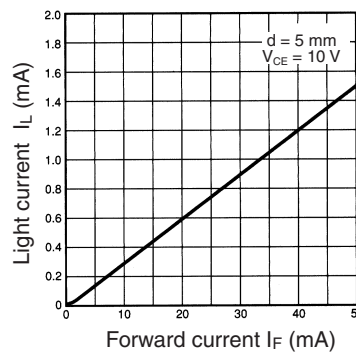

**Light Current vs. Collector–Emitter Voltage Characteristics (Typical)**

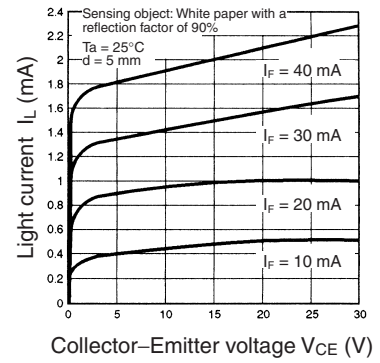

**Relative Light Current vs. Ambient Temperature Characteristics (Typical)**

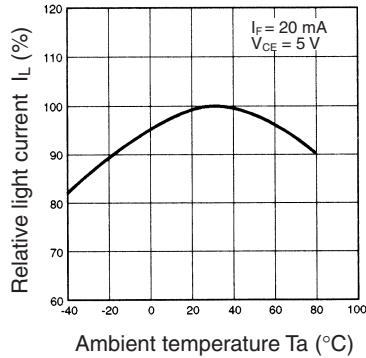

**Dark Current vs. Ambient Temperature Characteristics (Typical)**

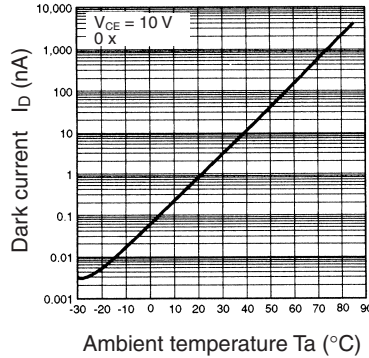

**Response Time vs. Load Resistance Characteristics (Typical)**

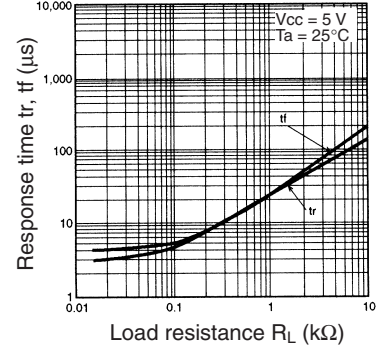

**Sensing Distance Characteristics (Typical)**

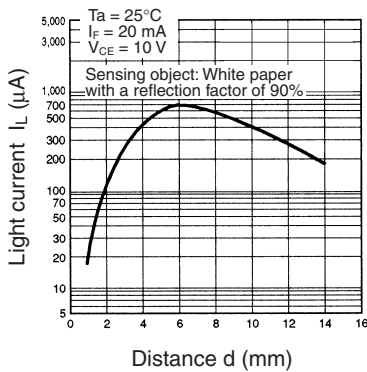

**Sensing Position Characteristics (Typical)**

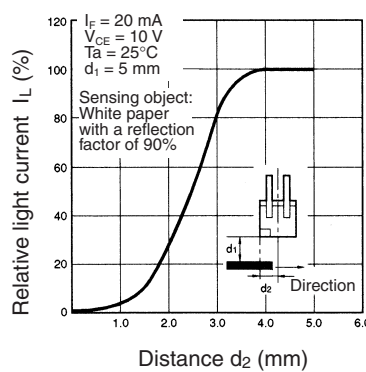

**Sensing Angle Characteristics (Typical)**

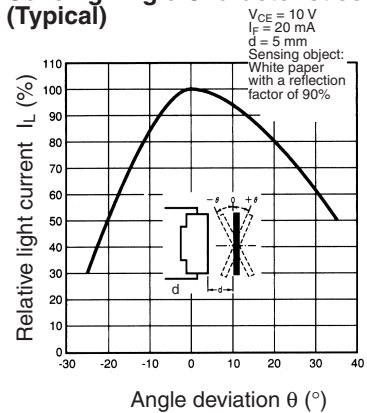

**Response Time Measurement Circuit**

