

OA205AN Series - All Metal

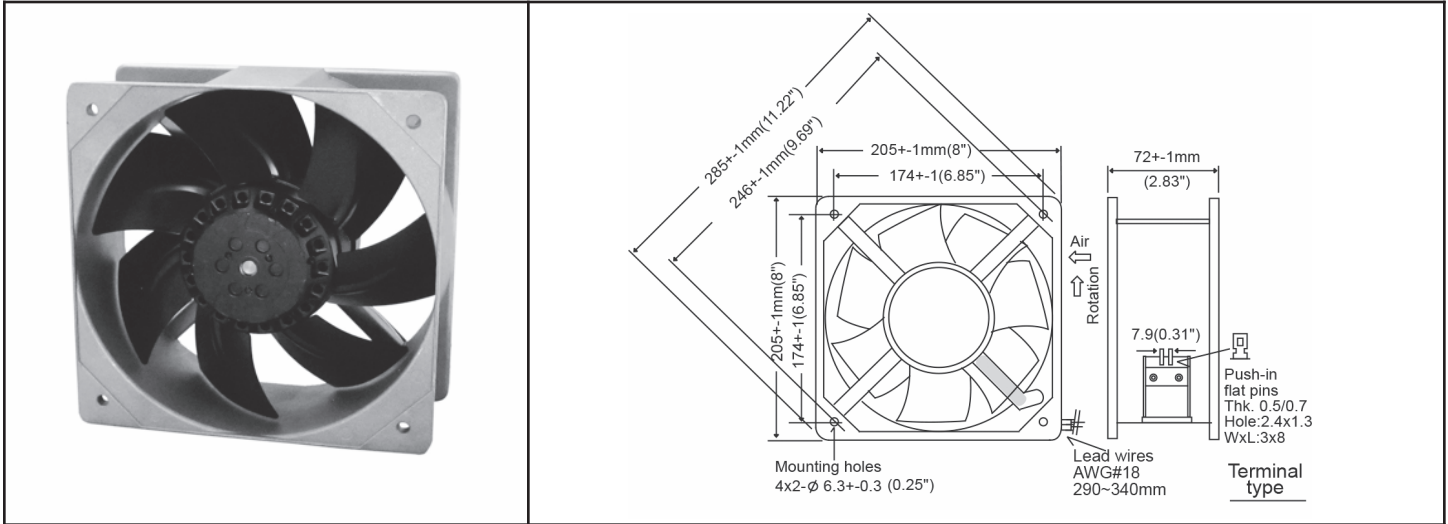

AC Fan - 115V, 230V
205 x 72mm (8.0" x 2.8")



Frame	Diecast Aluminum	Operating Temperature Ball Bearing -30C ~ +80C (non-condensing) Storage Temp -40C ~ +100C Life Expectancy Ball Bearing 50,000 hours (L10 at 55C) Environmental Protection IP56 Weight: ~ 5.0 lbs m0
Impeller	Metal Alloy	
Connection	2x Lead Wires 18 AWG or terminals	
Motor	AC Capacitor Inductance, thermally protected	
Bearing System	Dual ball bearing	
Insulation Resistance	>100M ohm between lead-wire and frame (500VDC)	
Dielectric Strength	1 min at 1500 VAC, 50/60Hz	

Model Number	Speed (RPM)	Airflow (CFM)	Noise (dB)	Volts AC	Voltage Range	Watts	Max. Static Pressure ("H ₂ O)	Curves
OA205AN-11-1 * 1856	2800 3200	550 650	68	115	100~120	95 105	1.05 1.08	2 (50Hz) 1 (60Hz)
OA205AN-11-2 * 1856	2300 2250	460 465	58	115	100~120	55 65	0.69 0.52	4 (50Hz) 3 (60Hz)
OA205AN-11-3 * 1856	1500 1650	310 330	48	115	100~120	32 40	0.38 0.29	6 (50Hz) 5 (60Hz)
OA205AN-22-1 * 1856	2800 3200	550 650	68	230	200~240	95 105	1.05 1.08	2 (50Hz) 1 (60Hz)
OA205AN-22-2 * 1856	2300 2250	460 465	58	230	200~240	55 65	0.69 0.52	4 (50Hz) 3 (60Hz)
OA205AN-22-3 * 1856	1500 1650	310 330	48	230	200~240	32 40	0.38 0.29	6 (50Hz) 5 (60Hz)

* Indicate "TB" for terminal type or "WB" for lead wires