



OD8032 Series

DC Fan - 12V, 24V, 48V
80 x 32mm (3.15 x 1.25in)



Model #	Pg #	Voltage	RPM	CFM	Noise Level	Max Static Pressure
OD8032-12H	2	12 VDC	3800	50	40 dB	.43 H ₂ O
OD8032-12M	2	12 VDC	3400	44	36 dB	.28 H ₂ O
OD8032-12L	2	12 VDC	3000	40	31 dB	.20 H ₂ O
OD8032-24H	2	24 VDC	3800	50	40 dB	.43 H ₂ O
OD8032-24M	2	24 VDC	3400	44	36 dB	.28 H ₂ O
OD8032-24L	2	24 VDC	3000	40	31 dB	.20 H ₂ O
OD8032-48H	2	48 VDC	3800	50	40 dB	.43 H ₂ O
OD8032-48M	2	48 VDC	3400	44	36 dB	.28 H ₂ O
OD8032-48L	2	48 VDC	3000	40	31 dB	.20 H ₂ O
OD8032-12HHB02A	3	12 VDC	4200	55.5	44 dB	.32 H ₂ O
OD8032-24HHB	4	24 VDC	4200	55.5	44 dB	.32 H ₂ O
OD8032-24HHB02A	5	24 VDC	4200	55.5	44 dB	.32 H ₂ O

** For some models and part numbers, minimum order quantities may apply.

OD8032 Series



DC Fan - 12, 24, 48V
80x32mm (3.15"x 1.25")

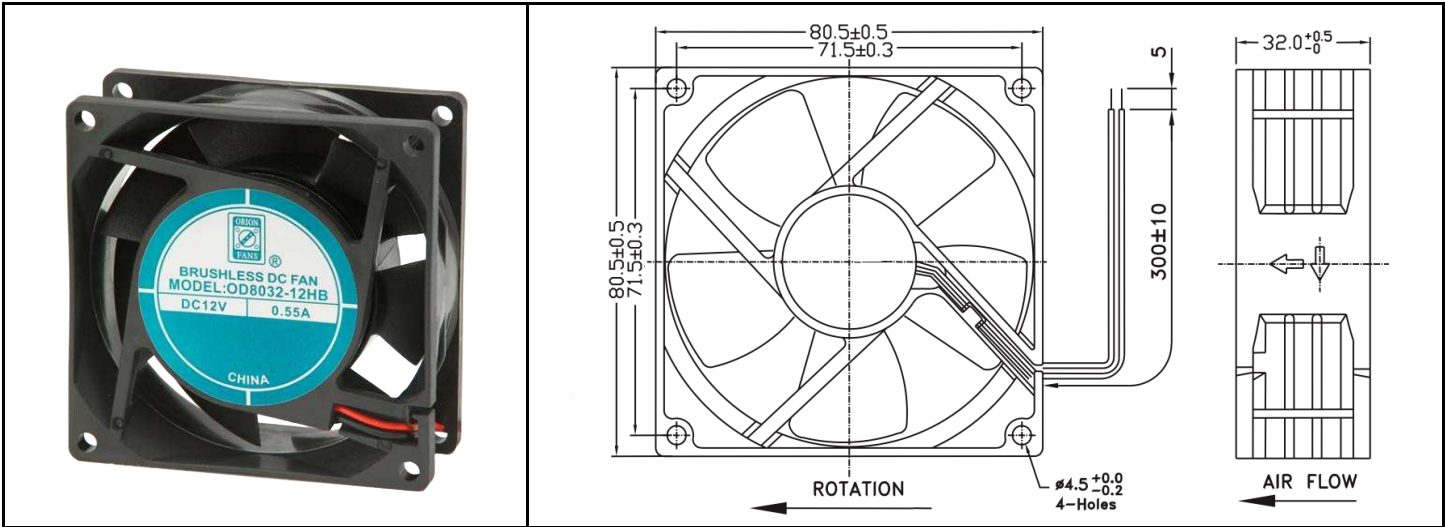

Frame & Impeller	PBT, UL94V-O plastic	Available Options: Tachometer (FG) Alarm (RD) Thermal Speed Control (Thermistor) PWM Input (Manual Speed Control) Life Expectancy (L10) Ball Bearing 70,000 hours (L10 at 40C) Sleeve Bearing 35,000 hours (L10 at 40C) Operating Temperature Ball Bearing -20C ~ +70C Sleeve Bearing -10C ~ +50C
Connection	2x Lead wires, UL1007, 24AWG	
Motor	Brushless DC, auto restart, polarity protected	
Bearing System	Dual Ball or Sleeve	
Insulation Resistance	10M ohm between leadwire and frame (500VDC)	
Dielectric Strength	1 second at 500 VAC, max leakage - 500 MicroAmp	
Storage Temperature	-30C ~ +90C	

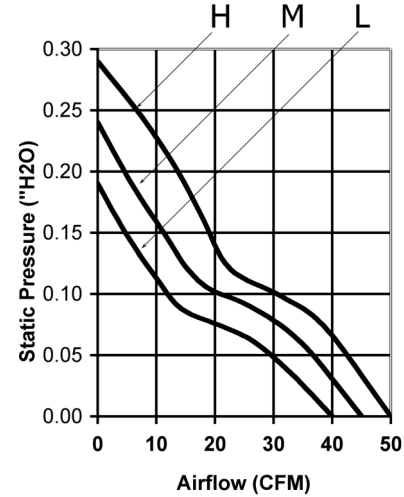

Model Number	Speed (RPM)	Airflow (CFM)	Noise (dB)	Volts DC	Voltage Range	Nominal Amps	Max. Static Pressure (\"H2O)
OD8032-12H*	3800	50	42	12	10.8~13.2	0.19	0.29
OD8032-12M*	3400	45	37	12	10.8~13.2	0.16	0.24
OD8032-12L*	3000	40	35	12	10.8~13.2	0.11	0.19
OD8032-24H*	3800	50	42	24	21.6~26.4	0.12	0.29
OD8032-24M*	3400	45	37	24	21.6~26.4	0.10	0.24
OD8032-24L*	3000	40	35	24	21.6~26.4	0.07	0.19
OD8032-48H*	3800	50	42	48	24~56	0.08	0.29
OD8032-48M*	3400	45	37	48	24~56	0.07	0.24
OD8032-48L*	3000	40	35	48	24~56	0.06	0.19

* Indicate "B" to specify Ball bearing or "S" to specify Sleeve bearing

OD8032-12HHB02A



DC Fan, 12VDC
80x32mm (3.15x1.25in)

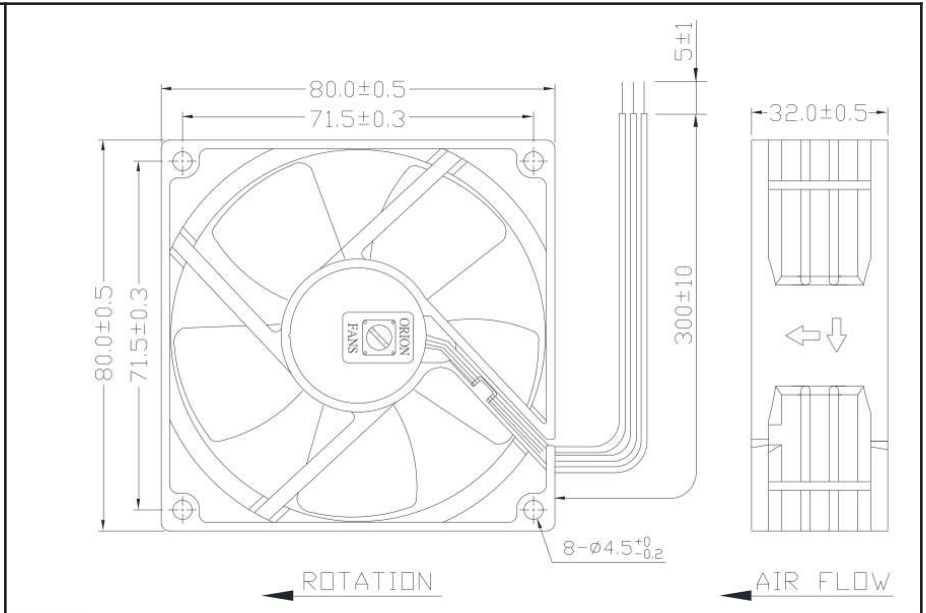

Frame & Impeller	PBT, UL94V-0 plastic	Available Options IP55 Other speeds and voltages Tachometer PWM *Connection: Wire Leads - UL1007 24AWG Red(+), Black(-), Yellow Alarm Weight: 108 g
Connection	3x Lead wires *	
Motor	Brushless DC, auto restart, polarity protected.	
Bearing System	Dual ball bearing	
Insulation Resistance	Min. 10M at 500VDC	
Dielectric Strength	1 second at 500VAC max leakage 500 microamp	
Temperature Range	-10C ~ +70C	
Storage Temperature	-40C ~ +80C	
Life (L10)	70,000 hours (40C)	

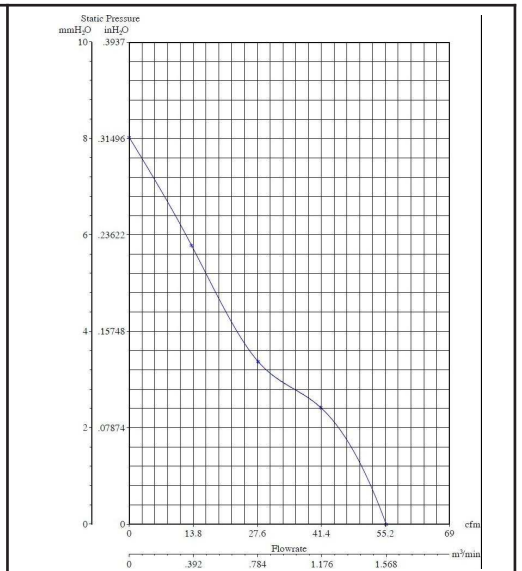

Model Number	OD8032-12HHB02A
Part Number	184151231
Nominal Voltage	12 VDC
Voltage Range	7~13.2 VDC
Nominal Current	.23 A
Rated Power	4.56 Watts
Rated Speed (RPM)	4200
Airflow (CFM)	55.5
Noise Level (dB)	44
Max. Static Pressure	.32 "H ₂ O

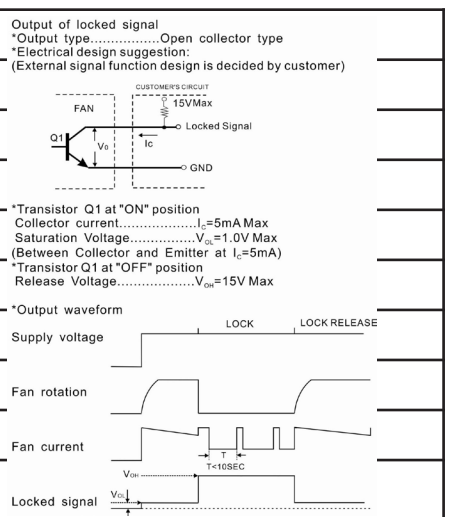

OD8032-24HHB



DC Fan, 24VDC
80x32mm (3.15x1.25in)

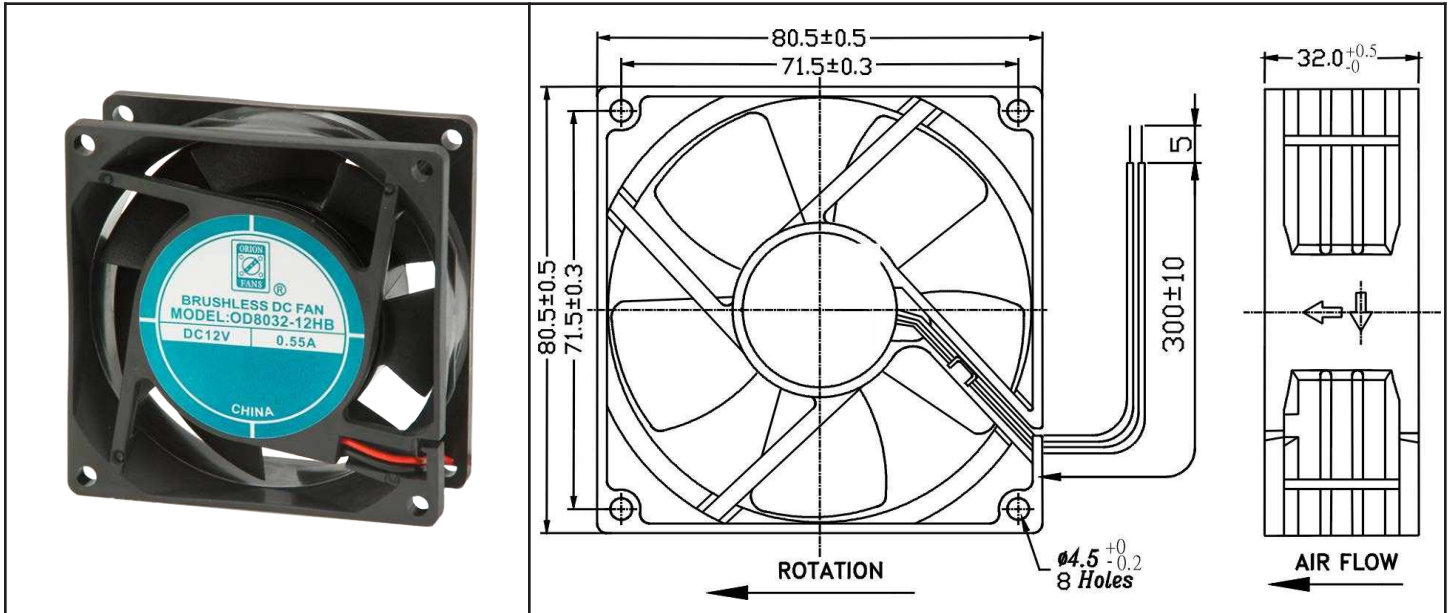

Frame & Impeller	PBT, UL94V-0 plastic	<u>Available Options</u> IP55 Other speeds and voltages Tachometer PWM Alarm *Connection: Wire Leads - UL1007 24AWG Red(+), Black (-), Weight: 108 g	
Connection	2x Lead wires *		
Motor	Brushless DC, auto restart, polarity protected.		
Bearing System	Dual ball bearing		
Insulation Resistance	Min. 10M at 500VDC		
Dielectric Strength	1 second at 500VAC max leakage 500 microamp		
Temperature Range	-10C ~ +70C		
Storage Temperature	-40C ~ +80C		
Life (L10)	70,000 hours (40C)		

Model Number	OD8032-24HHB
Part Number	184251001
Nominal Voltage	24 VDC
Voltage Range	17~26.4 VDC
Nominal Current	.15 A
Rated Power	4.32 Watts
Rated Speed (RPM)	4200
Airflow (CFM)	55.5
Noise Level (dB)	44
Max. Static Pressure	.32 "H ₂ O

OD8032-24HHB02A



DC Fan, 24VDC
80x32mm (3.15x1.25in)

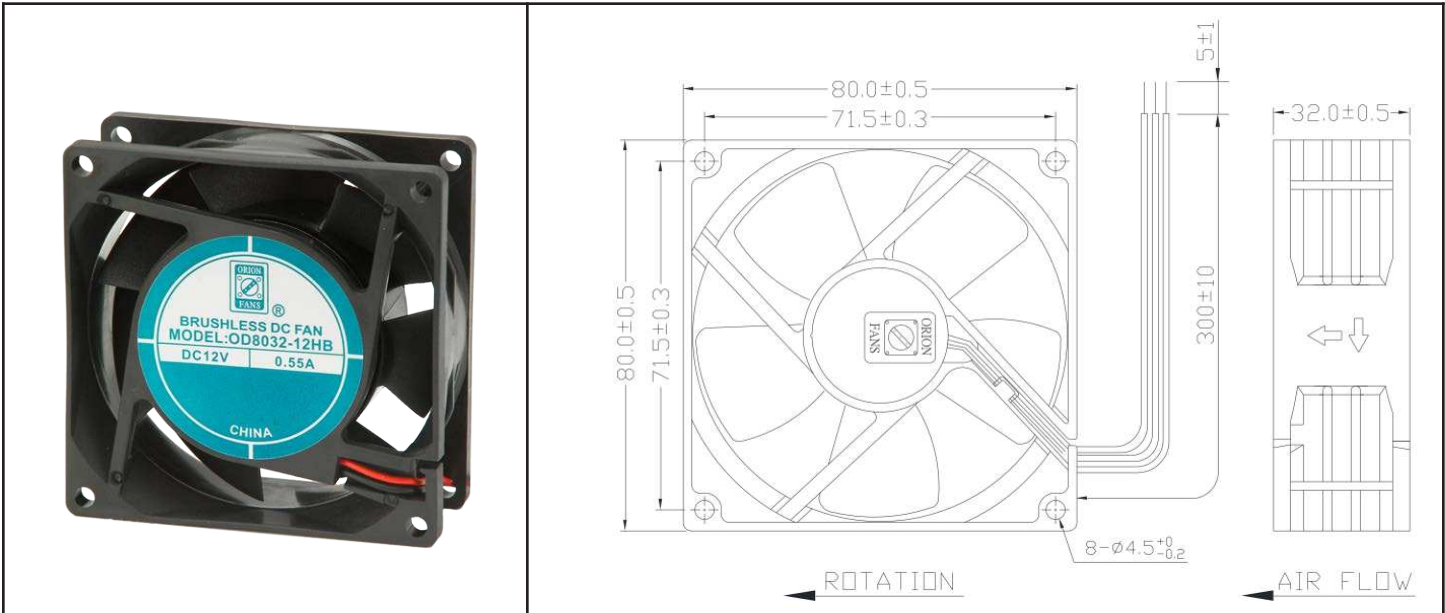

Frame & Impeller	PBT, UL94V-0 plastic	Available Options IP55 Other speeds and voltages Tachometer PWM *Connection: Wire Leads - UL1007 24AWG Red(+), Black (-), Yellow Alarm Weight: 108 g
Connection	3x Lead wires *	
Motor	Brushless DC, auto restart, polarity protected.	
Bearing System	Dual ball bearing	
Insulation Resistance	Min. 10M at 500VDC	
Dielectric Strength	1 second at 500VAC max leakage 500 microamp	
Temperature Range	-10C ~ +70C	
Storage Temperature	-40C ~ +80C	
Life (L10)	70,000 hours (40C)	

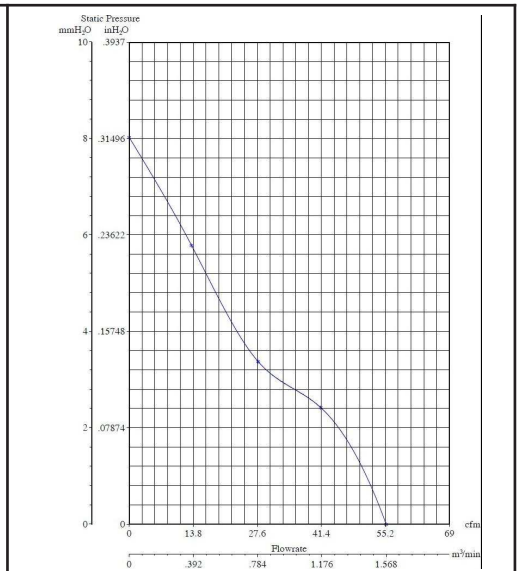

Model Number	OD8032-24HHB02A
Part Number	184251231
Nominal Voltage	24 VDC
Voltage Range	17~26.4 VDC
Nominal Current	.15 A
Rated Power	4.32 Watts
Rated Speed (RPM)	4200
Airflow (CFM)	55.5
Noise Level (dB)	44
Max. Static Pressure	.32 "H ₂ O

Output of locked signal
 *Output type.....Open collector type
 *Electrical design suggestion:
 (External signal function design is decided by customer)

*Transistor Q1 at "ON" position
 Collector current.....I_c=10mA Max
 Saturation Voltage.....V_{ce}=1.0V Max
 (Between Collector and Emitter at I_c=10mA)
 *Transistor Q1 at "OFF" position
 Release Voltage.....V_{on}=30V Max

*Output waveform