

Part No. G70 -4

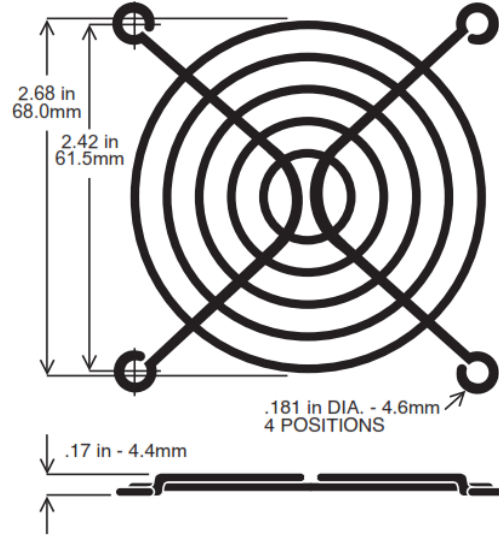

Fan Guard for
70mm Fan

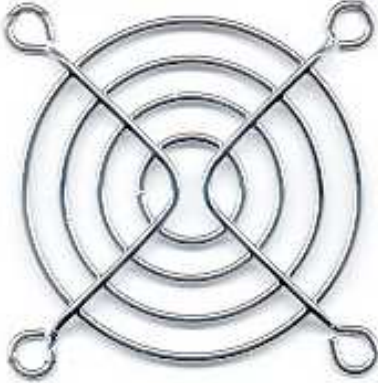

NOTES:

1. MATERIAL:C1008 BRIGHT BASIC WIRE
2. FINISH:BRIGHT NICKEL CHROME
3. RINGS: 1.6MM DIA / RIBS: 1.6MM DIA
4. WELDS TO WITHSTAND 88LBS PULL FORCE
5. SPACING BETWEEN RINGS: 4.33MM
6. GENERAL TOLERANCE UNLESS NOTED +/-0.5MM
7. PART MEETS 6.35MM PLUG GAUGE TEST
8. UNIT: MM

Part Number	Description
G70-4	70mm fan guard, metal
G70-4/PK	10-Pack G70-4, Boxed