

### Features

- Input voltage from 1.5 to 5.5 V
- Ultra low dropout voltage (80 mV typ. at 100 mA load)
- Very low quiescent current (20  $\mu$ A typ. at no load, 35  $\mu$ A typ. at 150 mA load, 1  $\mu$ A max in off mode)
- Very low noise (33  $\mu$ V<sub>RMS</sub> from 1 kHz to 100 kHz at  $V_{OUT} = 1.8$  V)
- Output voltage tolerance:  $\pm 2.0$  % @ 25 °C
- 150 mA guaranteed output current
- Wide range of output voltages available on request: 0.8 V to 4.5 V with 100 mV step
- Logic-controlled electronic shutdown
- Compatible with ceramic capacitor  $C_{OUT} = 1$   $\mu$ F
- Internal current and thermal limit
- Flip-chip 4 bumps 0.8 x 0.8 mm. pitch
- Temperature range: -40 °C to 125 °C

### Applications

- Mobile phones
- Personal digital assistants (PDAs)
- Cordless phones and similar battery-powered systems

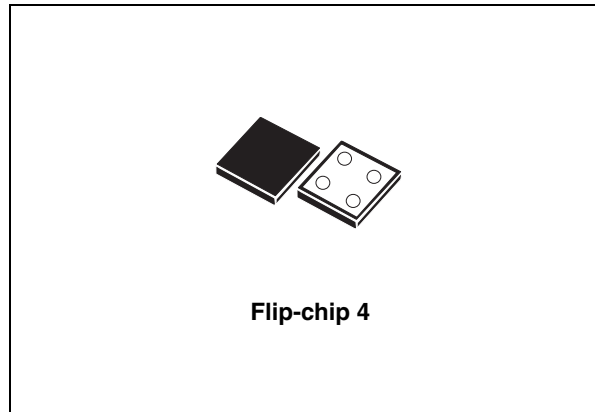

### Description

The LD39115Jxx provides 150 mA maximum current from an input voltage ranging from 1.5 V to 5.5 V with a typical dropout voltage of 80 mV. It is stabilized with a ceramic capacitor. The ultra low drop voltage, low quiescent current and low noise features make it suitable for low power battery-powered applications. Power supply rejection is 65 dB at low frequencies and starts to roll off at 10 kHz. An enable logic control function puts the LD39115Jxx in shutdown mode allowing a total current consumption lower than 1  $\mu$ A. The device also includes a short-circuit constant current limiting and thermal protection.

**Table 1. Device summary**

Part numbers	Order codes	Output voltages
LD39115JXX12	LD39115J12R	1.2 V
LD39115JXX15	LD39115J15R	1.5 V
LD39115JXX18	LD39115J18R	1.8 V
LD39115JXX25	LD39115J25R	2.5 V
LD39115JXX28	LD39115J28R	2.8 V
LD39115JXX30	LD39115J30R	3.0 V
LD39115JXX33	LD39115J33R	3.3 V

---

# Contents

1	Diagram .....	3
2	Pin configuration .....	4
3	Typical application .....	5
4	Maximum ratings .....	6
5	Electrical characteristics .....	7
6	Typical performance characteristics .....	11
7	Package mechanical data .....	17
8	Different output voltage versions of the LD39115Jxx available on request .....	21
9	Revision history .....	22

# 1 Diagram

Figure 1. Block diagram

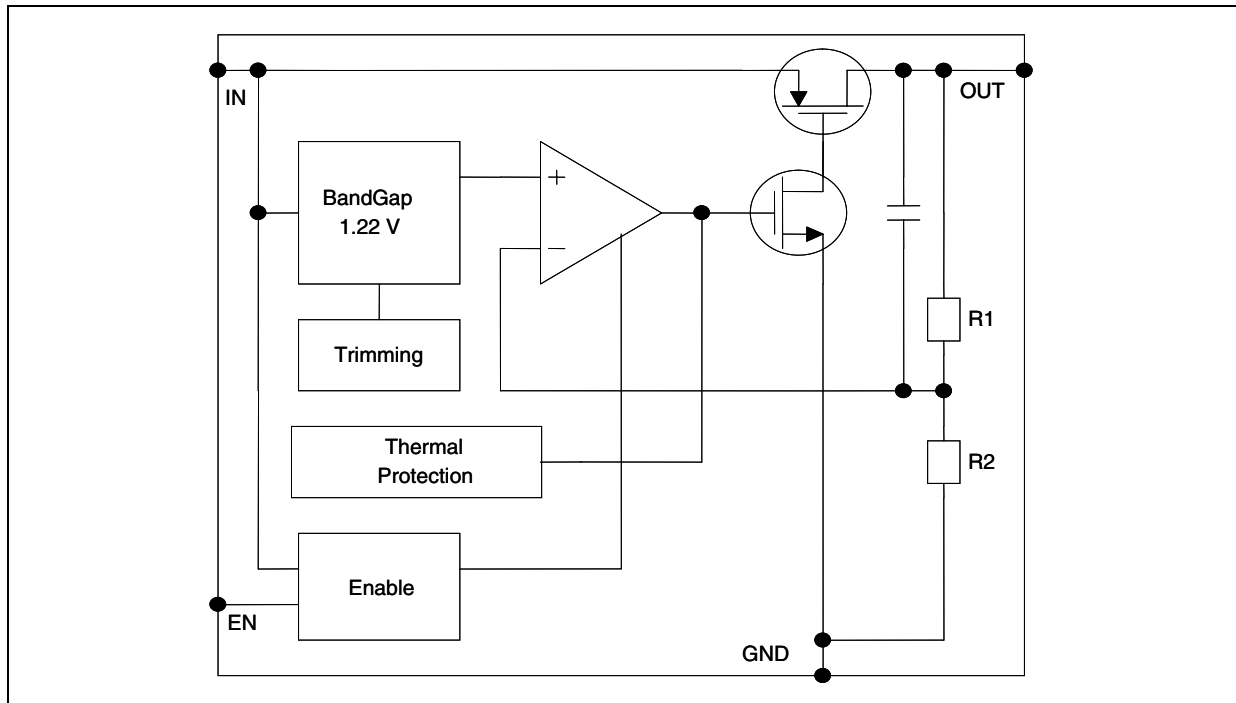

## 2 Pin configuration

Figure 2. Pin connection (top view)

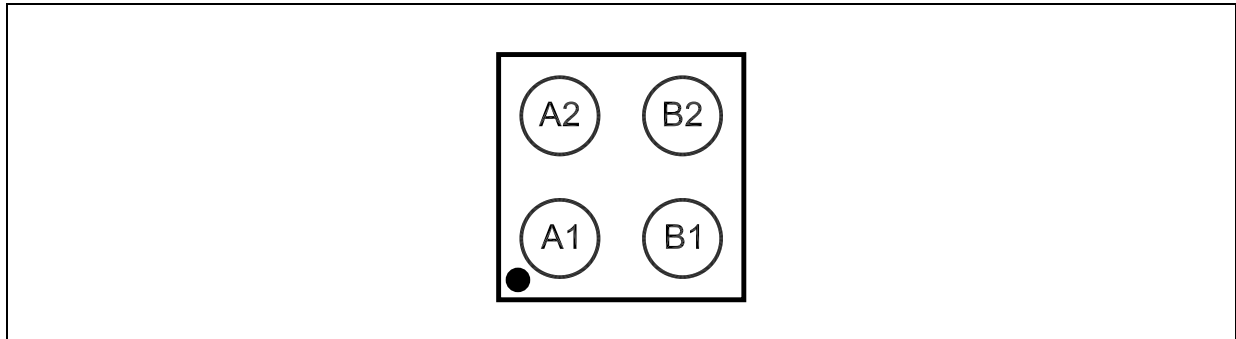
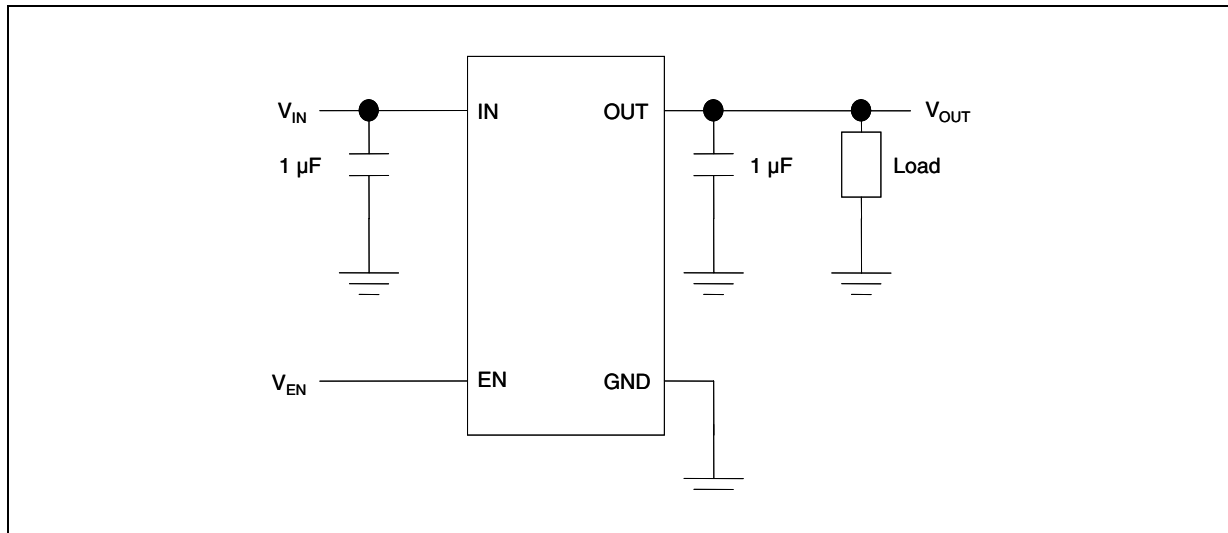

Table 2. Pin description

Pin n°	Symbol	Function
A2	EN	Enable pin logic input: Low = shutdown, High = active
A1	GND	Common ground
B2	IN	Input voltage of the LDO
B1	OUT	Output voltage

### 3 Typical application

Figure 3. Typical application circuit



## 4 Maximum ratings

**Table 3. Absolute maximum ratings**

Symbol	Parameter	Value	Unit
$V_{IN}$	DC input voltage	- 0.3 to 6	V
$V_{OUT}$	DC output voltage	- 0.3 to $V_I + 0.3$	V
$V_{EN}$	Enable input voltage	- 0.3 to $V_I + 0.3$	V
$I_{OUT}$	Output current	Internally limited	mA
$P_D$	Power dissipation	Internally limited	mW
$T_{STG}$	Storage temperature range	- 65 to 150	°C
$T_{OP}$	Operating junction temperature range	- 40 to 125	°C

*Note: Absolute maximum ratings are those values beyond which damage to the device may occur. Functional operation under these conditions is not implied. All values are referred to GND.*

**Table 4. Thermal data**

Symbol	Parameter	Value	Unit
$R_{thJA}$	Thermal resistance junction-ambient	180	°C/W

## 5 Electrical characteristics

$T_J = 25\text{ }^\circ\text{C}$ ,  $V_{IN} = V_{OUT(NOM)} + 1\text{ V}$ ,  $C_{IN} = C_{OUT} = 1\text{ }\mu\text{F}$ ,  $I_{OUT} = 1\text{ mA}$ ,  $V_{EN} = V_{IN}$ , unless otherwise specified.

**Table 5. Electrical characteristics for LD39115Jxx (1)**

Symbol	Parameter	Test conditions	Min.	Typ.	Max.	Unit
$V_{IN}$	Operating input voltage		1.5		5.5	V
$V_{UVLO}$	Turn-on threshold			1.45	1.48	V
	Turn-off threshold		1.30	1.35		mV
$V_{OUT}$	$V_{OUT}$ accuracy	$V_{OUT} > 1.5\text{V}$ , $I_{OUT} = 1\text{mA}$ , $T_J = 25^\circ\text{C}$	-2.0		2.0	%
		$V_{OUT} > 1.5\text{V}$ , $I_{OUT} = 1\text{mA}$ , $-40^\circ\text{C} < T_J < 125^\circ\text{C}$	-3.0		3.0	%
		$V_{OUT} \leq 1.5\text{V}$ , $I_{OUT} = 1\text{mA}$		$\pm 10$		mV
		$V_{OUT} \leq 1.5\text{V}$ , $I_{OUT} = 1\text{mA}$ , $-40^\circ\text{C} < T_J < 125^\circ\text{C}$		$\pm 30$		mV
$\Delta V_{OUT}$	Static line regulation	$V_{OUT} + 1\text{V} \leq V_{IN} \leq 5.5\text{V}$ , $I_{OUT} = 1\text{mA}$		0.01		%/V
$\Delta V_{OUT}$	Transient line regulation (2)	$\Delta V_{IN} = +500\text{mV}$ , $I_{OUT} = 1\text{mA}$ , $T_R = T_F = 5\mu\text{s}$		10		mVpp
$\Delta V_{OUT}$	Static load regulation	$I_{OUT} = 1\text{mA}$ to $150\text{mA}$		0.002		%/mA
$\Delta V_{OUT}$	Transient load regulation (2)	$I_{OUT} = 1\text{mA}$ to $150\text{mA}$ , $t_R = t_F = 5\mu\text{s}$		40		mVpp
$V_{DROP}$	Dropout voltage (3)	$I_{OUT} = 100\text{mA}$ , $V_{OUT} > 1.5\text{V}$ , $-40^\circ\text{C} < T_J < 125^\circ\text{C}$		80	110	mV
$e_N$	Output noise voltage	10Hz to 100kHz, $I_{OUT} = 10\text{mA}$		30		$\mu\text{V}_{RMS}/\text{V}$
SVR	Supply voltage rejection $V_{OUT} = 1.5\text{V}$	$V_{IN} = V_{OUTNOM} + 1\text{V} \pm V_{RIPPLE}$ $V_{RIPPLE} = 0.1\text{V}$ Freq. = 1kHz $I_{OUT} = 10\text{mA}$		74		dB
		$V_{IN} = V_{OUTNOM} + 0.5\text{V} \pm V_{RIPPLE}$ $V_{RIPPLE} = 0.1\text{V}$ Freq. = 10kHz $I_{OUT} = 10\text{mA}$		67		
$I_Q$	Quiescent current	$I_{OUT} = 0\text{mA}$		20		$\mu\text{A}$
		$I_{OUT} = 0\text{mA}$ , $-40^\circ\text{C} < T_J < 125^\circ\text{C}$			50	
		$I_{OUT} = 0$ to $150\text{mA}$		35		
		$I_{OUT} = 0$ to $150\text{mA}$ , $-40^\circ\text{C} < T_J < 125^\circ\text{C}$			70	
		$V_{IN}$ input current in OFF MODE: $V_{EN} = \text{GND}$		0.001	1	
$I_{SC}$	Short circuit current	$R_L = 0$	200			mA
$V_{EN}$	Enable input logic low	$V_{IN} = 1.5\text{V}$ to $5.5\text{V}$ , $-40^\circ\text{C} < T_J < 125^\circ\text{C}$			0.4	V
	Enable input logic high	$V_{IN} = 1.5\text{V}$ to $5.5\text{V}$ , $-40^\circ\text{C} < T_J < 125^\circ\text{C}$	0.9			
$I_{EN}$	Enable pin input current	$V_{SHDN} = V_{IN}$		0.1	100	nA
$T_{ON}$	Turn on time (4)			30		$\mu\text{s}$

**Table 5. Electrical characteristics for LD39115Jxx (continued) (1)**

Symbol	Parameter	Test conditions	Min.	Typ.	Max.	Unit
$T_{\text{SHDN}}$	Thermal shutdown			160		°C
	Hysteresis			20		
$C_{\text{OUT}}$	Output capacitor	Capacitance (see <a href="#">Section 6: Typical performance characteristics</a> )	1		22	μF

1. For  $V_{\text{OUT(NOM)}} < 1.2 \text{ V}$ ,  $V_{\text{IN}} = 1.5 \text{ V}$ .
2. All transient values are guaranteed by design, not production tested.
3. Dropout voltage is the input-to-output voltage difference at which the output voltage is 100 mV below its nominal value. This specification does not apply for output voltages below 1.5 V.
4. Turn-on time is time measured between the enable input just exceeding  $V_{\text{EN}}$  high value and the output voltage just reaching 95 % of its nominal value.



$T_J = 25\text{ }^\circ\text{C}$ ,  $V_{IN} = V_{OUT(NOM)} + 1\text{ V}$ ,  $C_{IN} = C_{OUT} = 1\text{ }\mu\text{F}$ ,  $I_{OUT} = 1\text{ mA}$ ,  $V_{EN} = V_{IN}$ , unless otherwise specified.

**Table 6. Electrical characteristics for LD39115SJxx (1)**

Symbol	Parameter	Test conditions	Min.	Typ.	Max.	Unit
$V_{IN}$	Operating input voltage		1.5		5.5	V
$V_{UVLO}$	Turn-on threshold			1.45	1.48	V
	Turn-off threshold		1.30	1.35		mV
$V_{OUT}$	$V_{OUT}$ accuracy	$V_{OUT} > 1.5\text{V}$ , $I_{OUT}=1\text{mA}$ , $T_J=25\text{ }^\circ\text{C}$	-2.0		2.0	%
		$V_{OUT} > 1.5\text{V}$ , $I_{OUT}=1\text{mA}$ , $-40\text{ }^\circ\text{C} < T_J < 125\text{ }^\circ\text{C}$	-3.0		3.0	%
		$V_{OUT} \leq 1.5\text{V}$ , $I_{OUT}=1\text{mA}$		$\pm 10$		mV
		$V_{OUT} \leq 1.5\text{V}$ , $I_{OUT}=1\text{mA}$ , $-40\text{ }^\circ\text{C} < T_J < 125\text{ }^\circ\text{C}$		$\pm 30$		mV
$\Delta V_{OUT}$	Static line regulation	$V_{OUT} + 1\text{V} \leq V_{IN} \leq 5.5\text{V}$ , $I_{OUT}=1\text{mA}$		0.01		%/V
$\Delta V_{OUT}$	Transient line regulation (2)	$\Delta V_{IN}=+500\text{mV}$ , $I_{OUT}=1\text{mA}$ , $T_R=T_F=5\mu\text{s}$		10		mVpp
$\Delta V_{OUT}$	Static load regulation	$I_{OUT} = 1\text{mA}$ to $150\text{mA}$		0.002		%/mA
$\Delta V_{OUT}$	Transient load regulation (2)	$I_{OUT} = 1\text{mA}$ to $150\text{mA}$ , $T_R=T_F=5\mu\text{s}$		40		mVpp
$V_{DROP}$	Dropout voltage (3)	$I_{OUT} = 100\text{mA}$ , $V_{OUT}>1.5\text{V}$ , $-40\text{ }^\circ\text{C} < T_J < 125\text{ }^\circ\text{C}$		80	110	mV
$e_N$	Output noise voltage	10Hz to 100kHz, $I_{OUT}=10\text{mA}$		30		$\mu\text{V}_{RMS}/\text{V}$
SVR	Supply voltage rejection $V_{OUT} = 1.5\text{V}$	$V_{IN} = V_{OUTNOM} + 1\text{V} + /-V_{RIPPLE}$ $V_{RIPPLE} = 0.1\text{V}$ Freq.=1kHz $I_{OUT}=10\text{mA}$		74		dB
		$V_{IN} = V_{OUTNOM} + 0.5\text{V} + /-V_{RIPPLE}$ $V_{RIPPLE}=0.1\text{V}$ Freq.=10kHz $I_{OUT}=10\text{mA}$		67		
$I_Q$	Quiescent current	$I_{OUT}=0\text{mA}$		20		$\mu\text{A}$
		$I_{OUT}=0\text{mA}$ , $-40\text{ }^\circ\text{C} < T_J < 125\text{ }^\circ\text{C}$			50	
		$I_{OUT}=0$ to $150\text{mA}$		35		
		$I_{OUT}=0$ to $150\text{mA}$ , $-40\text{ }^\circ\text{C} < T_J < 125\text{ }^\circ\text{C}$			70	
		$V_{IN}$ input current in OFF MODE: $V_{EN}=\text{GND}$		0.001	1	
$I_{SC}$	Short circuit current	$R_L=0$	200			mA
$V_{EN}$	Enable input logic low	$V_{IN}=1.5\text{V}$ to $5.5\text{V}$ , $-40\text{ }^\circ\text{C} < T_J < 125\text{ }^\circ\text{C}$			0.4	V
	Enable input logic high	$V_{IN} = 1.5\text{V}$ to $5.5\text{V}$ , $-40\text{ }^\circ\text{C} < T_J < 125\text{ }^\circ\text{C}$	0.9			
$I_{EN}$	Enable pin input current	$V_{SHDN}=V_{IN}$		0.1	100	nA
$T_{ON}$	Turn on time (4)			100		$\mu\text{s}$

**Table 6. Electrical characteristics for LD39115SJxx (continued) <sup>(1)</sup>**

Symbol	Parameter	Test conditions	Min.	Typ.	Max.	Unit
T <sub>SHDN</sub>	Thermal shutdown			160		°C
	Hysteresis			20		
C <sub>OUT</sub>	Output capacitor	Capacitance (see <a href="#">Section 6: Typical performance characteristics</a> )	1		22	μF

1. For V<sub>OUT(NOM)</sub> < 1.2 V, V<sub>IN</sub> = 1.5 V.
2. All transient values are guaranteed by design, not production tested.
3. Dropout voltage is the input-to-output voltage difference at which the output voltage is 100 mV below its nominal value. This specification does not apply for output voltages below 1.5 V.
4. Turn-on time is time measured between the enable input just exceeding V<sub>EN</sub> high value and the output voltage just reaching 95 % of its nominal value.

## 6 Typical performance characteristics

$C_{IN} = C_{OUT} = 1 \mu F$ ,  $V_{EN}$  to  $V_{IN}$ .

Figure 4. Output voltage vs. temperature ( $V_{IN} = 2.2 V$ )

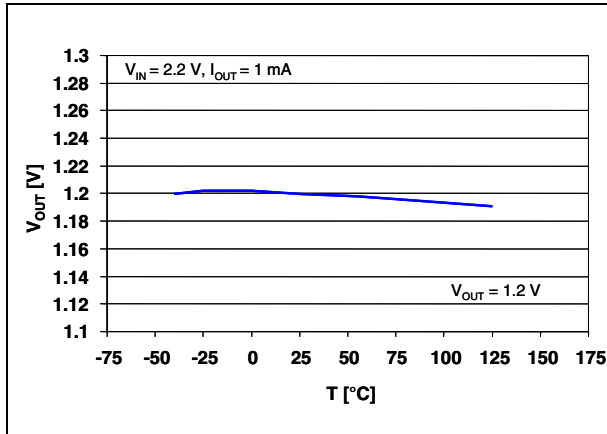

Figure 5. Output voltage vs. temperature ( $V_{IN} = 3.8 V$ )

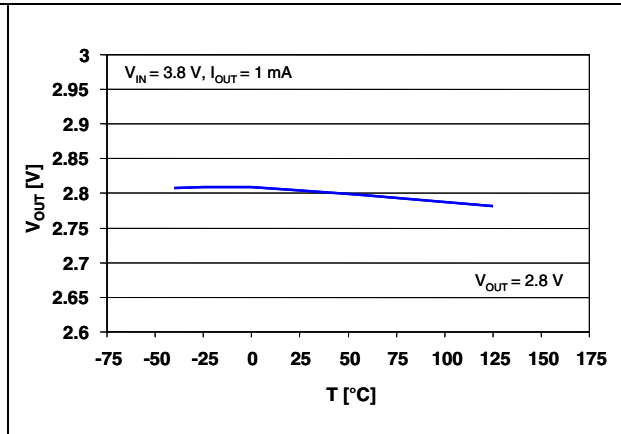

Figure 6. Line regulation vs. temperature

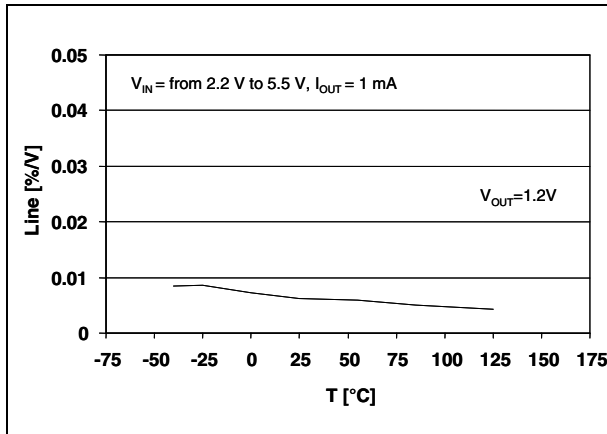

Figure 7. Load regulation vs. temperature

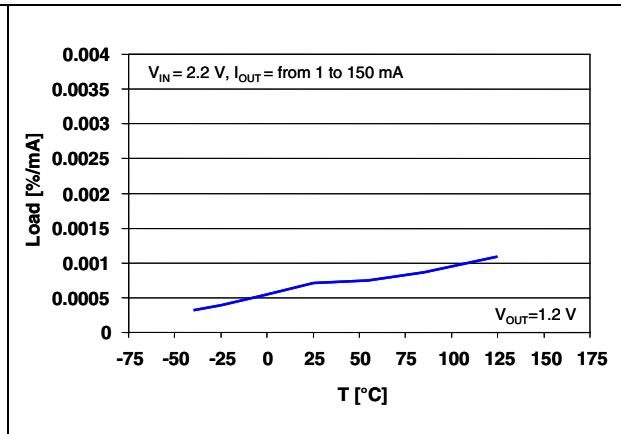

Figure 8. Short-circuit current vs. drop voltage

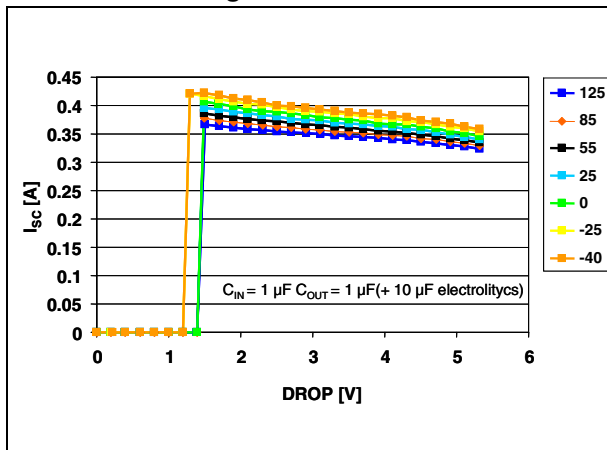

Figure 9. Dropout voltage vs. temperature

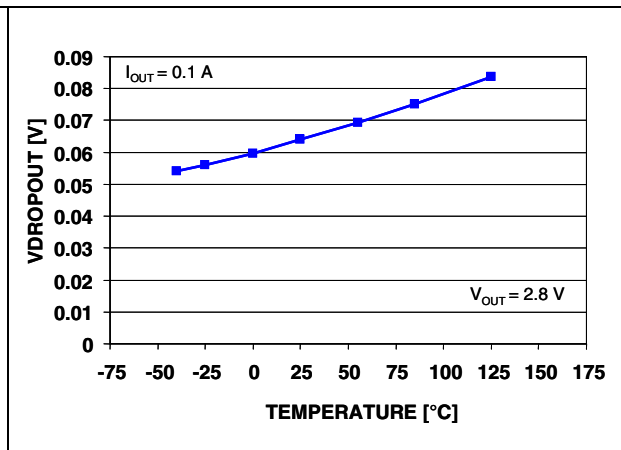

Figure 10. Dropout voltage vs. output current

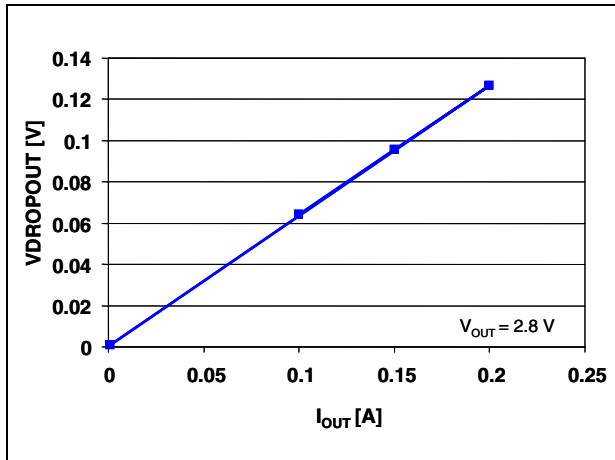

Figure 11. Output voltage vs. input voltage ( $I_{OUT} = 0.15$  A)

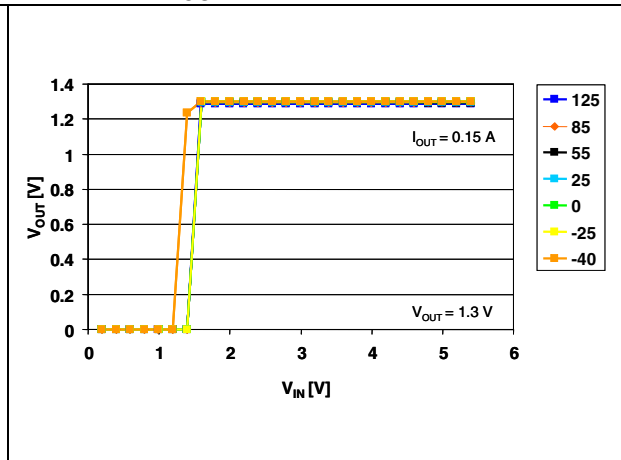

Figure 12. Output voltage vs. input voltage ( $V_{OUT} = 1.3$  V)

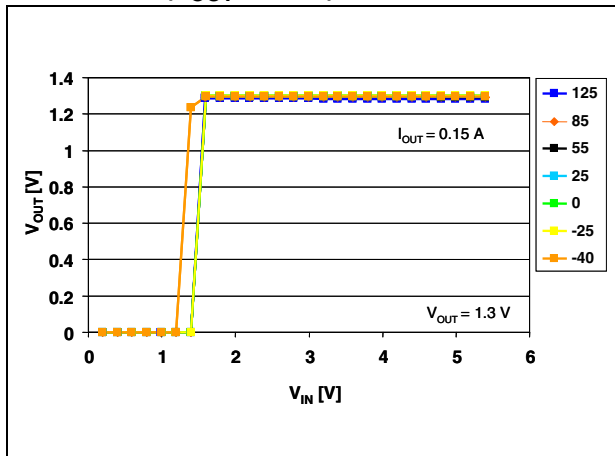

Figure 13. Output voltage vs. input voltage ( $V_{OUT} = 2.8$  V)

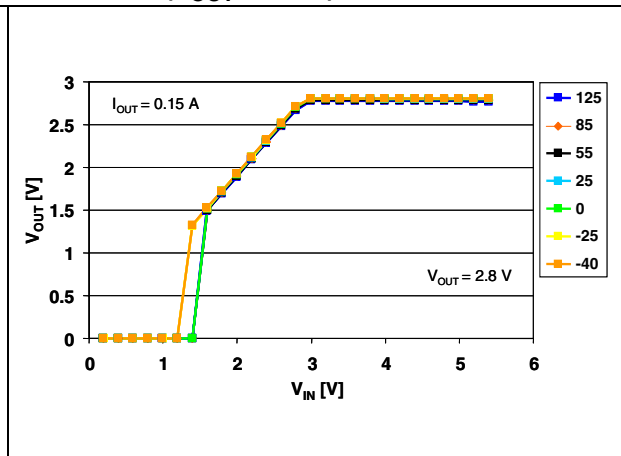

Figure 14. Enable threshold vs. temperature

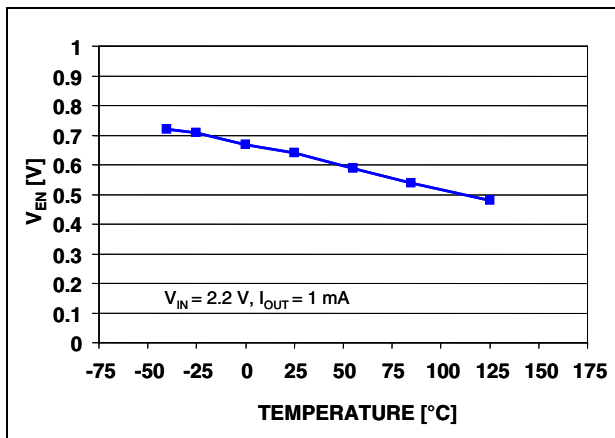

Figure 15. Quiescent current vs. temperature ( $V_{OUT} = 1.2$  V)

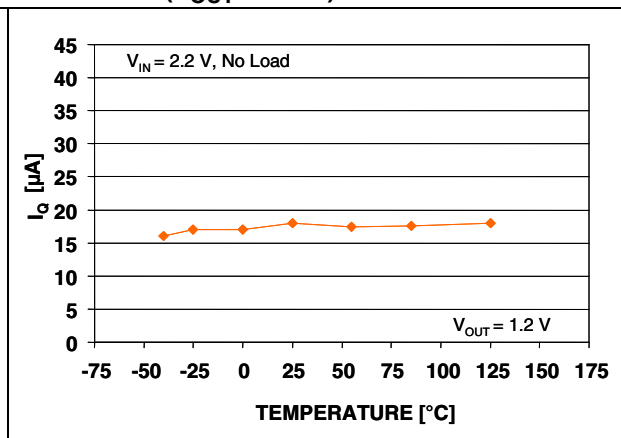

Figure 16. Quiescent current vs. temperature ( $V_{IN} = 2.2\text{ V}$ )

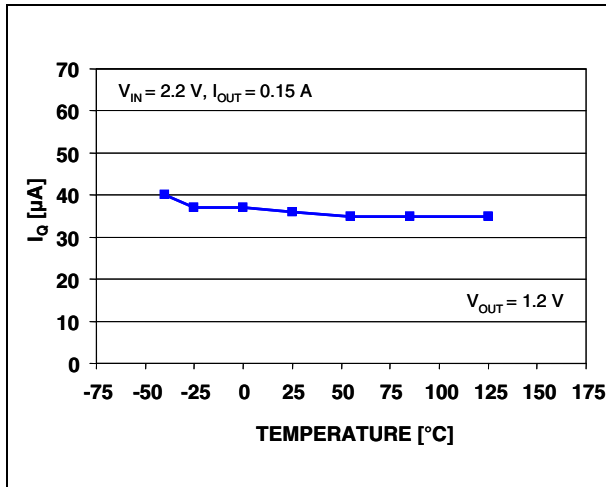

Figure 17. Quiescent current vs. temperature ( $V_{IN} = 3.8\text{ V}$ )

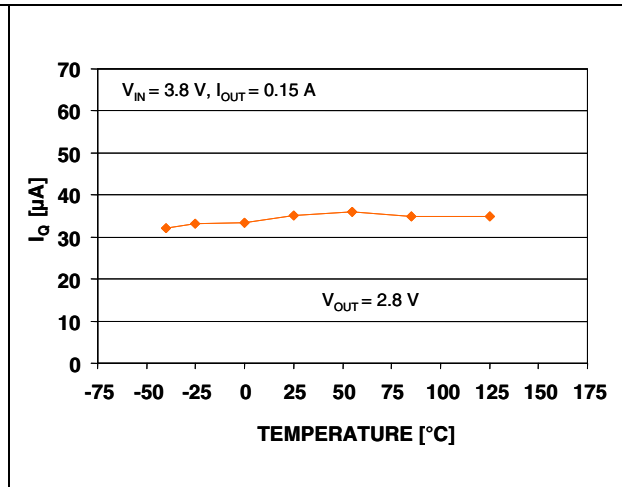

Figure 18. Quiescent current vs. input voltage

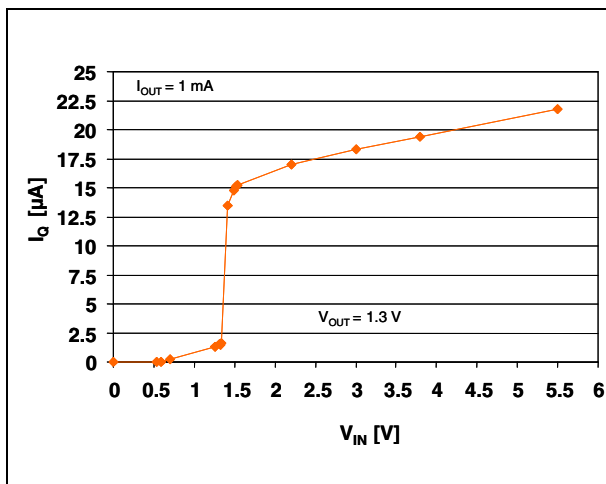

Figure 19. Quiescent current vs. output current

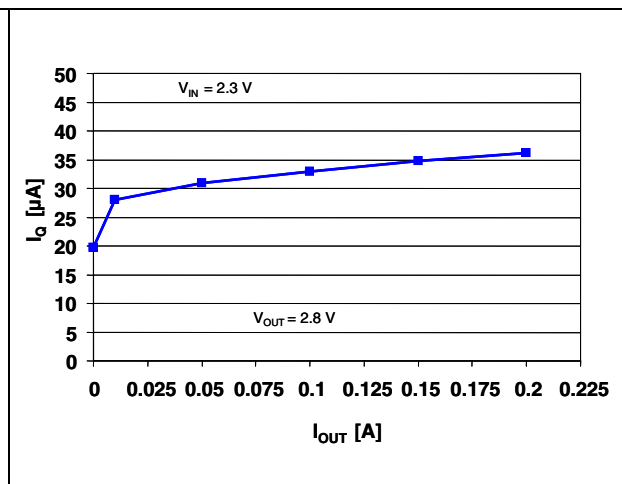

Figure 20. Supply voltage rejection vs. temperature ( $V_{OUT} = 1.2\text{ V}$ )

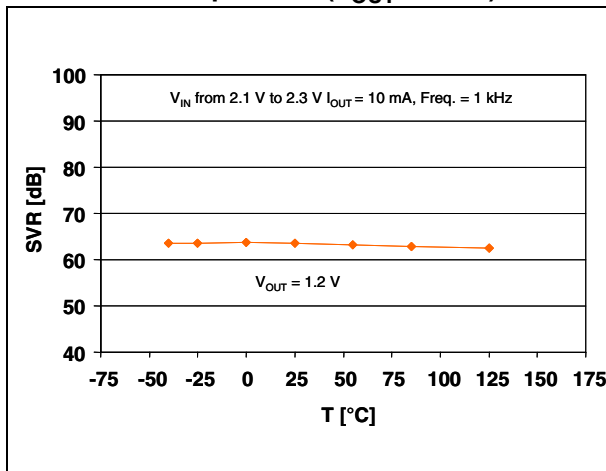

Figure 21. Supply voltage rejection vs. temperature ( $V_{OUT} = 1.3\text{ V}$ )

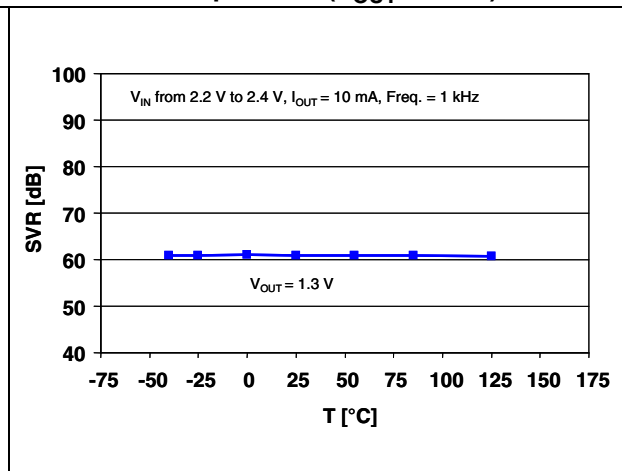

Figure 22. Supply voltage rejection vs. temperature (Freq. = 1 kHz)

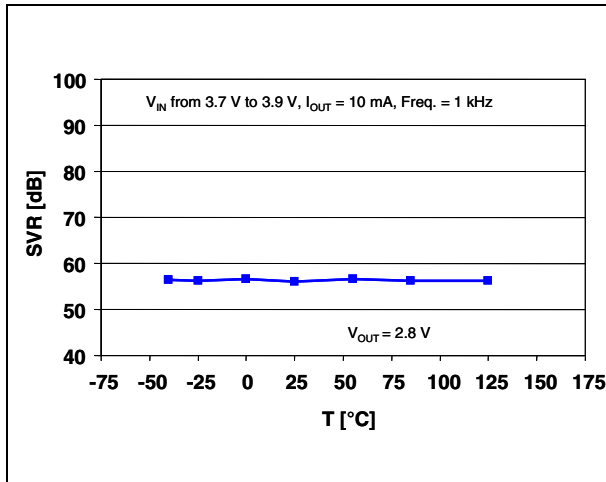

Figure 23. Supply voltage rejection vs. temperature (Freq. = 10 kHz)

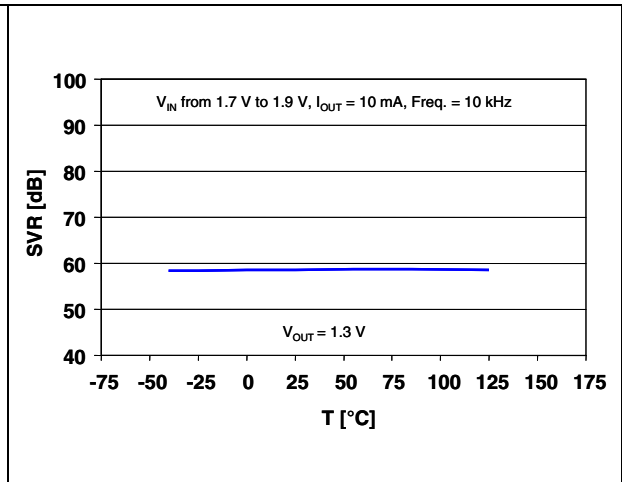

Figure 24. Supply voltage rejection vs. temperature ( $V_{OUT} = 2.8$  V)

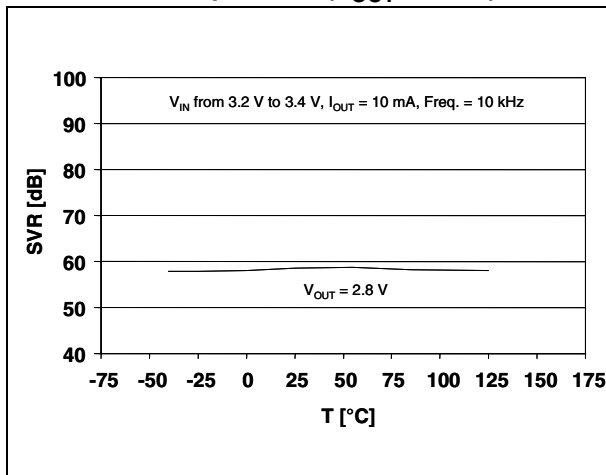

Figure 25. Supply voltage rejection vs. frequency ( $V_{OUT} = 1.2$  V)

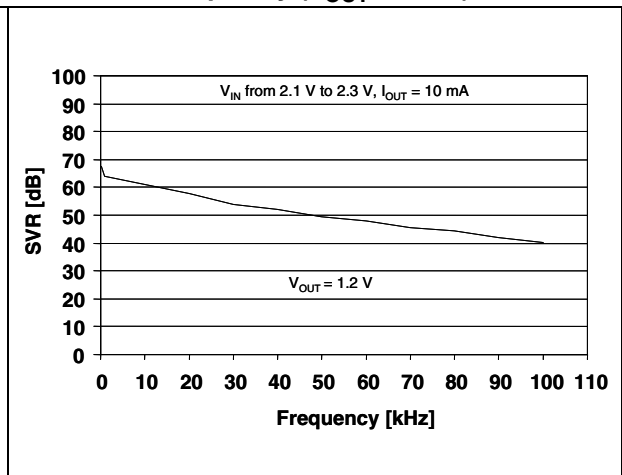

Figure 26. Supply voltage rejection vs. frequency ( $V_{OUT} = 1.3$  V)

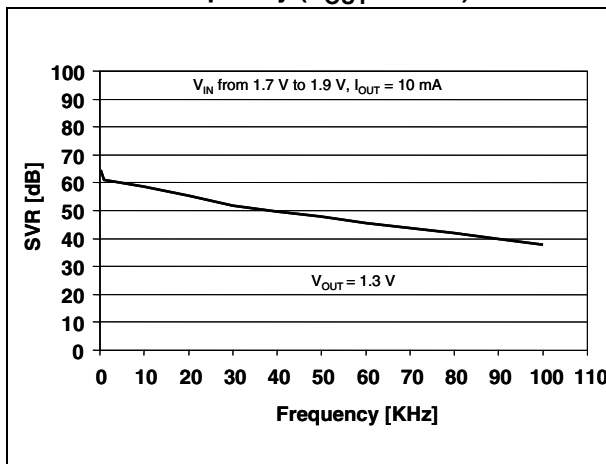

Figure 27. Supply voltage rejection vs. frequency ( $V_{OUT} = 2.8$  V)

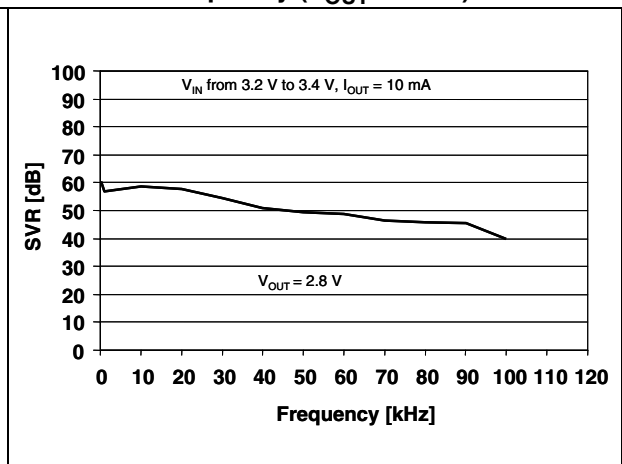

Figure 28. Supply voltage rejection vs. output current

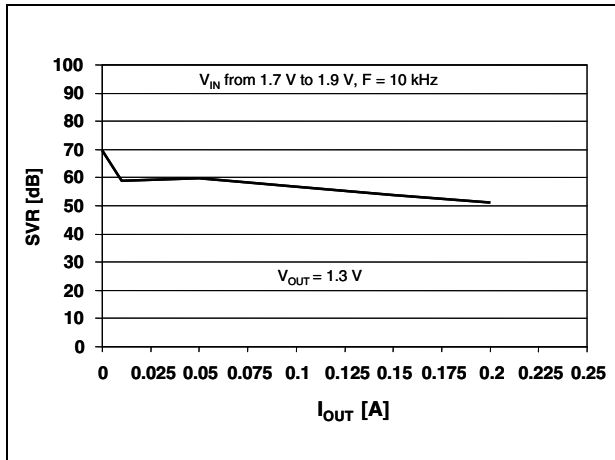

Figure 29. LD39115J noise

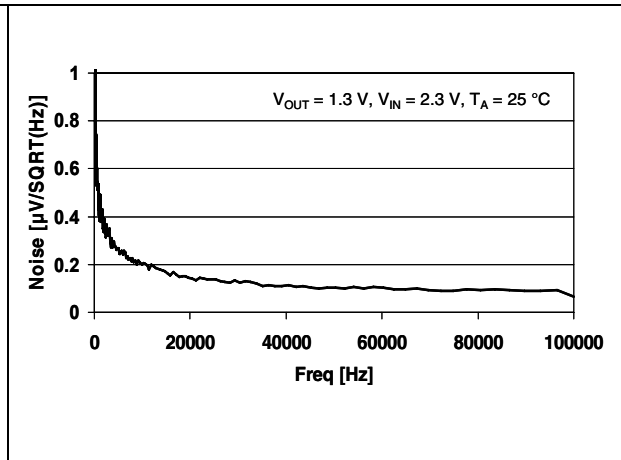

Figure 30. Line regulation transient

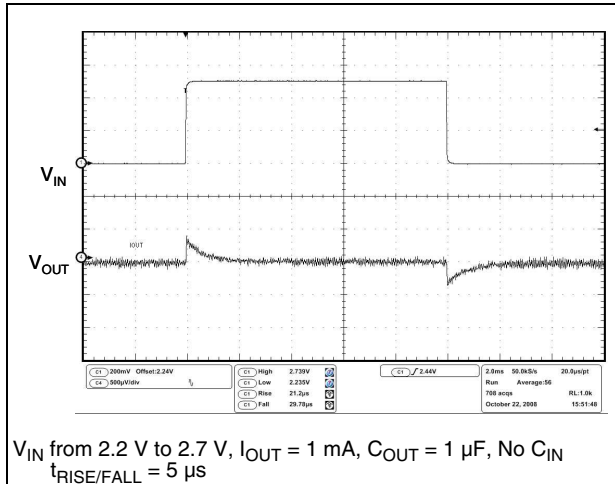

Figure 31. Start up transient

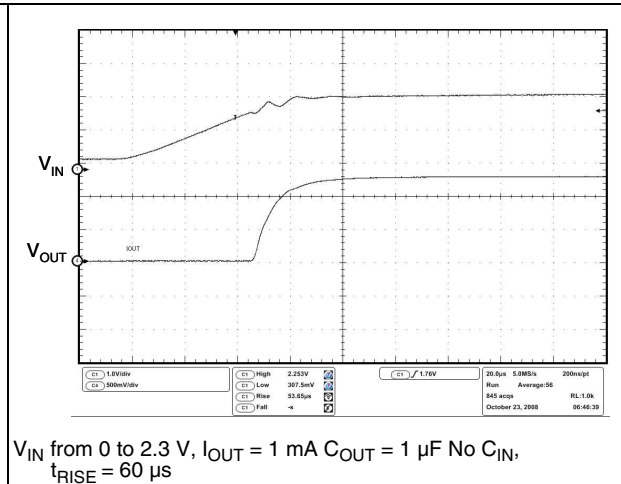

Figure 32. Enable transient (VOUT = 1.2 V)

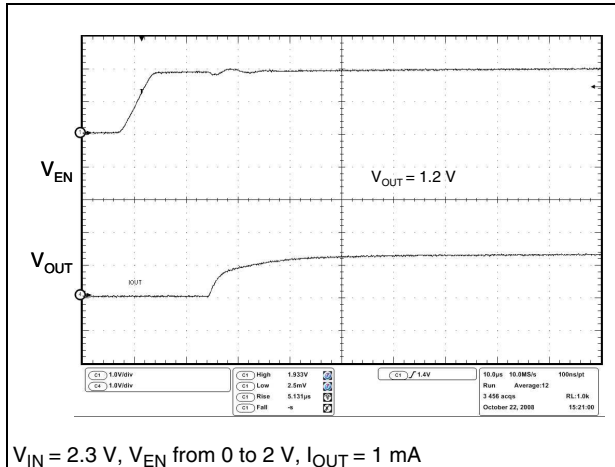

Figure 33. Enable transient (VOUT = 2.8 V)

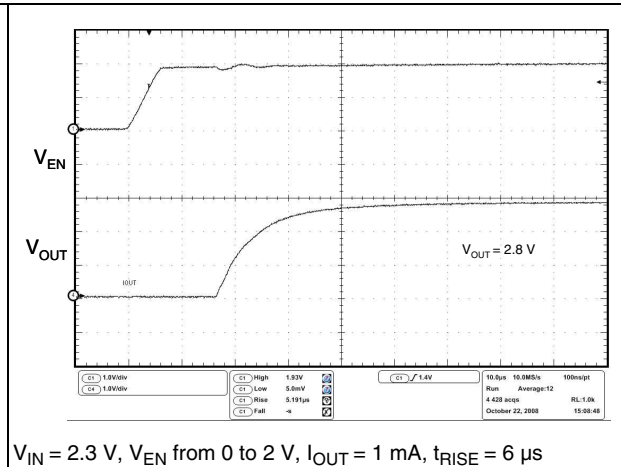
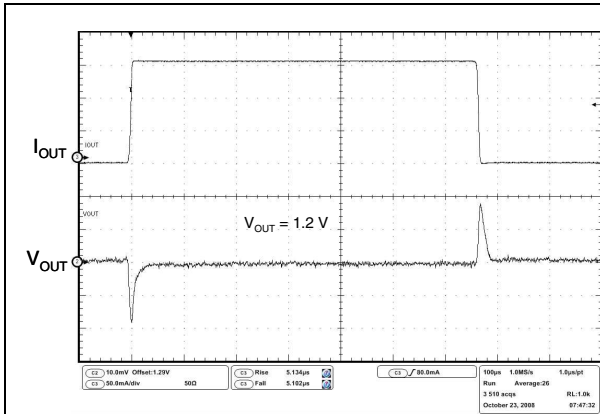
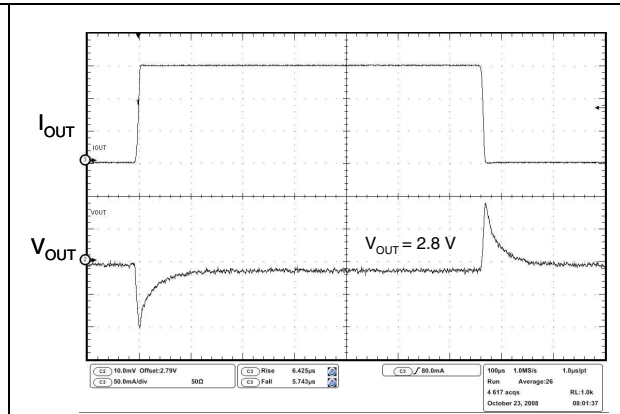

Figure 34. Load transient ( $V_{OUT} = 1.2\text{ V}$ )



$V_{IN} = 2.2\text{ V}$ ,  $I_{OUT} = \text{from } 1 \text{ to } 150\text{ mA}$ ,  $t_{RISE/FALL} = 5\ \mu\text{s}$

Figure 35. Load transient ( $V_{OUT} = 2.8\text{ V}$ )



$V_{in} = 3.8\text{ V}$ ,  $I_{OUT} = \text{from } 1 \text{ to } 150\text{ mA}$ ,  $t_{RISE/FALL} = 5\ \mu\text{s}$

Figure 36. ESR required for stability with ceramics capacitors

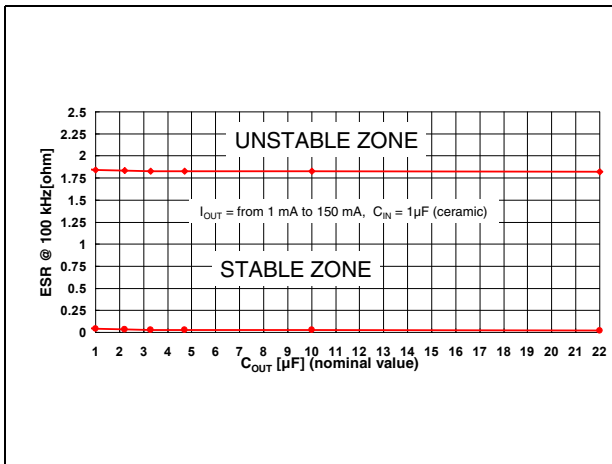



## 7 Package mechanical data

In order to meet environmental requirements, ST offers these devices in different grades of ECOPACK<sup>®</sup> packages, depending on their level of environmental compliance. ECOPACK<sup>®</sup> specifications, grade definitions and product status are available at: [www.st.com](http://www.st.com). ECOPACK<sup>®</sup> is an ST trademark.

**Flip-chip 4 mechanical data**

Dim.	mm.		
	Min.	Typ.	Max.
A	0.52	0.56	0.60
A1	0.17	0.20	0.23
A2	0.35	0.36	0.37
b	0.23	0.25	0.29
D	0.758	0.788	0.818
D1		0.4	
E	0.758	0.788	0.818
E1		0.4	
SD	0.18	0.2	0.22
SE	0.18	0.2	0.22
f		0.199	
ccc		0.075	

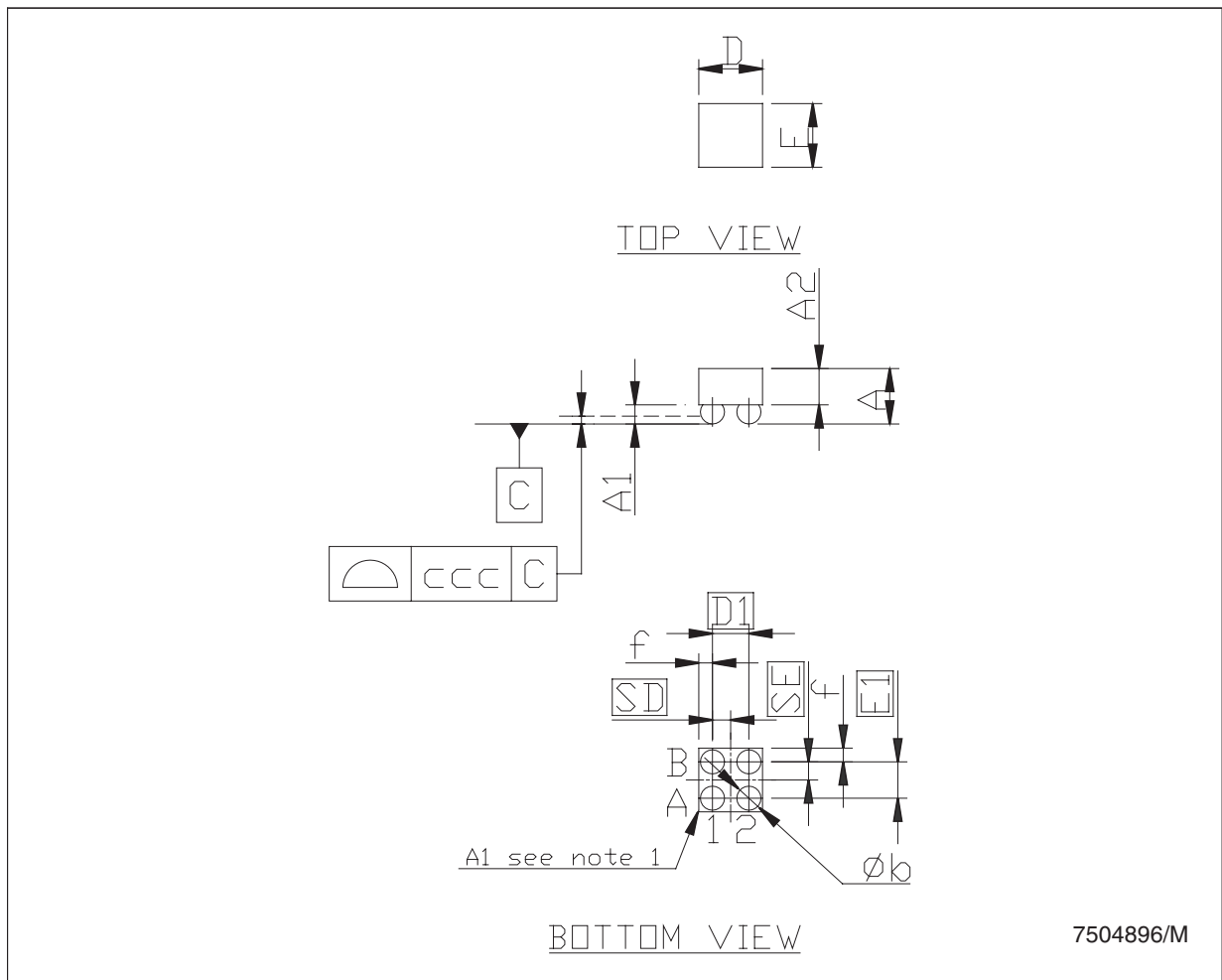

**Tape and reel Flip-chip 4 mechanical data**

Dim.	mm.			inch.		
	Min.	Typ.	Max.	Min.	Typ.	Max.
A			178			6.926
C	12.8		13.2	0.504		0.519
D	20.2			0.795		
N	59	60	61	2.323	2.362	2.401
T			8.4			0.331
Ao	0.82	0.87	0.92	0.032	0.034	0.036
Bo	0.82	0.87	0.92	0.032	0.034	0.036
Ko	0.64	0.69	0.74	0.025	0.027	0.029
Po	3.9	4	4.1	0.153	0.157	0.161
P	3.9	4	4.1	0.153	0.157	0.161

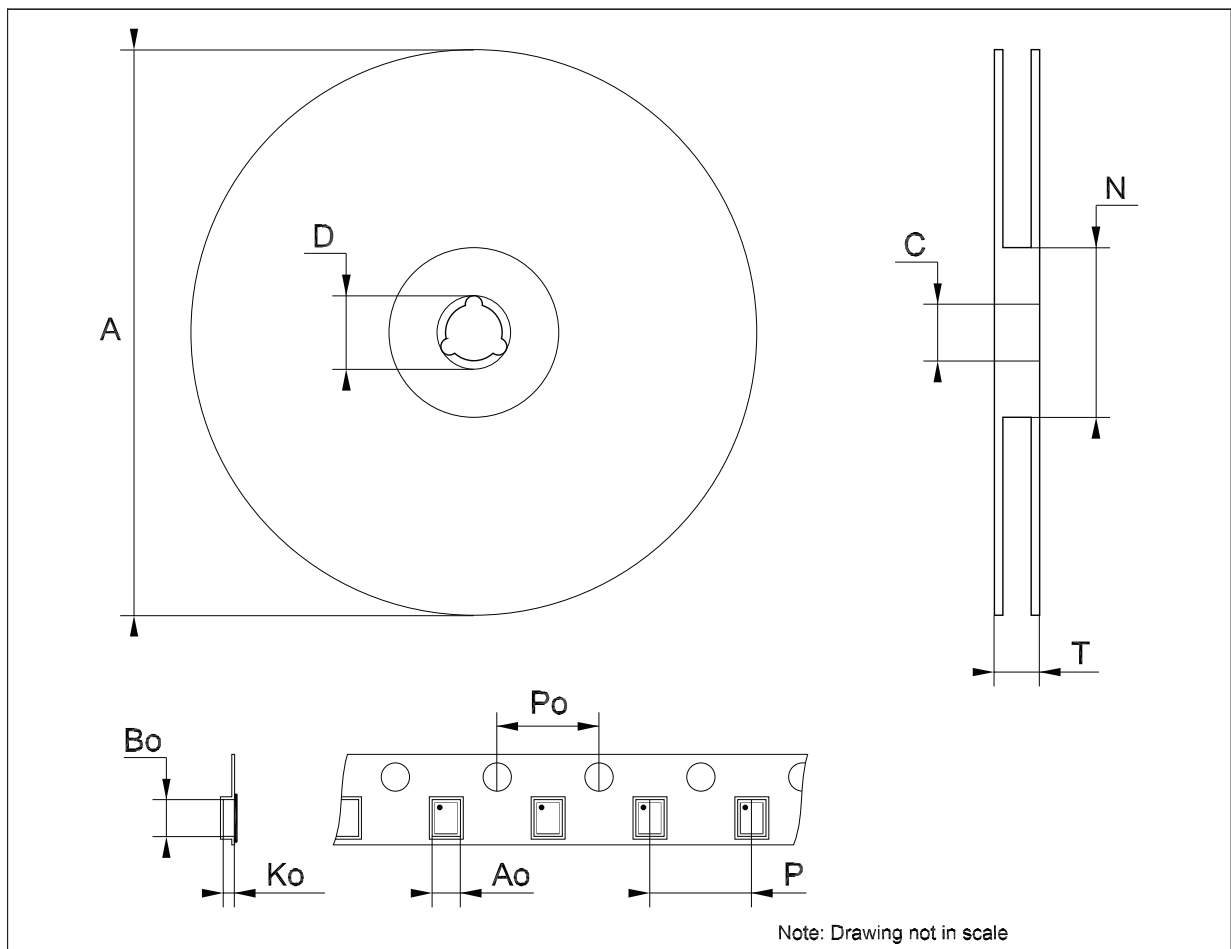
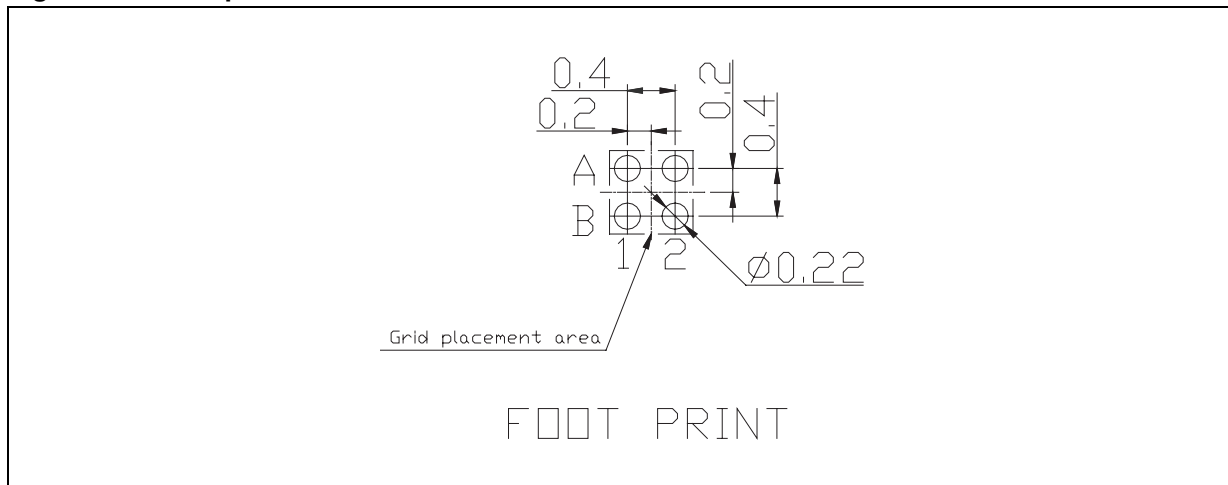

Figure 37. Foot print data



## 8 Different output voltage versions of the LD39115Jxx available on request

Table 7. Options available on request

Order codes	Output voltages
LD39115J08R	0.8 V
LD39115J10R	1.0 V

## 9 Revision history

**Table 8. Document revision history**

Date	Revision	Changes
26-Mar-2009	1	Initial release.
12-Jun-2009	2	Modified: <a href="#">Table 1 on page 1</a> and <a href="#">Table 7 on page 21</a> .
05-Aug-2009	3	Modified: tape and reel mechanical data <a href="#">on page 19</a> .
17-May-2011	4	Modified: <a href="#">Table 1 on page 1</a> and <a href="#">Table 7 on page 21</a> .
20-Dec-2011	5	Added: new order code LD39115J25R <a href="#">Table 1 on page 1</a> .

**Please Read Carefully:**

Information in this document is provided solely in connection with ST products. STMicroelectronics NV and its subsidiaries ("ST") reserve the right to make changes, corrections, modifications or improvements, to this document, and the products and services described herein at any time, without notice.

All ST products are sold pursuant to ST's terms and conditions of sale.

Purchasers are solely responsible for the choice, selection and use of the ST products and services described herein, and ST assumes no liability whatsoever relating to the choice, selection or use of the ST products and services described herein.

No license, express or implied, by estoppel or otherwise, to any intellectual property rights is granted under this document. If any part of this document refers to any third party products or services it shall not be deemed a license grant by ST for the use of such third party products or services, or any intellectual property contained therein or considered as a warranty covering the use in any manner whatsoever of such third party products or services or any intellectual property contained therein.

**UNLESS OTHERWISE SET FORTH IN ST'S TERMS AND CONDITIONS OF SALE ST DISCLAIMS ANY EXPRESS OR IMPLIED WARRANTY WITH RESPECT TO THE USE AND/OR SALE OF ST PRODUCTS INCLUDING WITHOUT LIMITATION IMPLIED WARRANTIES OF MERCHANTABILITY, FITNESS FOR A PARTICULAR PURPOSE (AND THEIR EQUIVALENTS UNDER THE LAWS OF ANY JURISDICTION), OR INFRINGEMENT OF ANY PATENT, COPYRIGHT OR OTHER INTELLECTUAL PROPERTY RIGHT.**

**UNLESS EXPRESSLY APPROVED IN WRITING BY TWO AUTHORIZED ST REPRESENTATIVES, ST PRODUCTS ARE NOT RECOMMENDED, AUTHORIZED OR WARRANTED FOR USE IN MILITARY, AIR CRAFT, SPACE, LIFE SAVING, OR LIFE SUSTAINING APPLICATIONS, NOR IN PRODUCTS OR SYSTEMS WHERE FAILURE OR MALFUNCTION MAY RESULT IN PERSONAL INJURY, DEATH, OR SEVERE PROPERTY OR ENVIRONMENTAL DAMAGE. ST PRODUCTS WHICH ARE NOT SPECIFIED AS "AUTOMOTIVE GRADE" MAY ONLY BE USED IN AUTOMOTIVE APPLICATIONS AT USER'S OWN RISK.**

Resale of ST products with provisions different from the statements and/or technical features set forth in this document shall immediately void any warranty granted by ST for the ST product or service described herein and shall not create or extend in any manner whatsoever, any liability of ST.

ST and the ST logo are trademarks or registered trademarks of ST in various countries.

Information in this document supersedes and replaces all information previously supplied.

The ST logo is a registered trademark of STMicroelectronics. All other names are the property of their respective owners.

© 2011 STMicroelectronics - All rights reserved

STMicroelectronics group of companies

Australia - Belgium - Brazil - Canada - China - Czech Republic - Finland - France - Germany - Hong Kong - India - Israel - Italy - Japan - Malaysia - Malta - Morocco - Philippines - Singapore - Spain - Sweden - Switzerland - United Kingdom - United States of America

[www.st.com](http://www.st.com)