



AIS326DQ

MEMS inertial sensor 3-axis, low g accelerometer with digital output

Features

- 3.3 V single supply operation
- 1.8 V compatible IOs
- SPI digital output interface
- 12 bit resolution
- Interrupt activated by motion
- Programmable interrupt threshold
- Embedded self-test
- High shock survivability
- ECOPACK[®] compliant
- Extended temperature range -40 °C to +105 °C

Applications

- Anti-theft systems and inertial navigation
- Motion activated functions
- Vibration monitoring and compensation
- Tilt measurements
- Black boxes, event recorders

Description

The AIS326DQ is a three axes digital output accelerometer that includes a sensing element and an IC interface able to take the information from the sensing element and to provide the measured acceleration signals to the external world through an SPI serial interface. I²C compatible interface is also available.

The sensing element, capable of detecting the acceleration, is manufactured using a dedicated

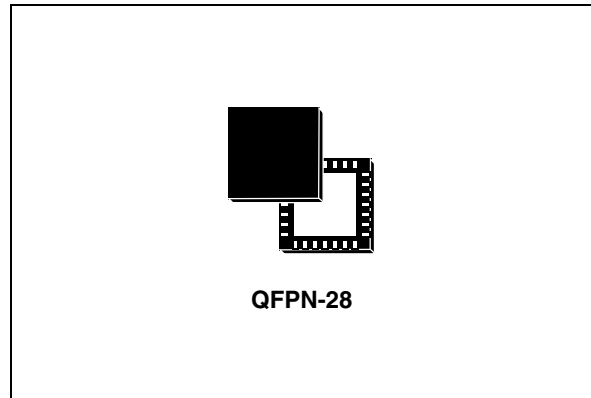

process developed by ST to produce inertial sensors and actuators in silicon.

The IC interface instead is manufactured using a CMOS process that allows high level of integration to design a dedicated circuit which is factory trimmed to better match the sensing element characteristics.

The AIS326DQ has a user selectable full scale of $\pm 2 g$, $\pm 6 g$ and it is capable of measuring acceleration over a bandwidth of 640 Hz for all axes. The device bandwidth may be selected accordingly to the application requirements. The self-test capability allows the user to check the functioning of the system.

The device is available in plastic quad flat package no lead surface mount (QFPN) and it is specified over a temperature range extending from -40 °C to +105 °C.

Table 1. Device summary

Order code	Operating temperature range [°C]	Package	Packing
AIS326DQ	-40 to +105	QFPN-28	Tray
AIS326DQTR	-40 to +105	QFPN-28	Tape and reel

Contents

- 1 Block diagram and pin description 8**
 - 1.1 Block diagram 8
 - 1.2 QFPN-28 pin description 8

- 2 Mechanical and electrical specifications 10**
 - 2.1 Mechanical characteristics 10
 - 2.2 Electrical characteristics 12
 - 2.3 Communication interface characteristics 13
 - 2.3.1 SPI - serial peripheral interface 13
 - 2.4 Absolute maximum ratings 14
 - 2.5 Terminology 15
 - 2.5.1 Sensitivity 15
 - 2.5.2 Zero-g level 15
 - 2.5.3 Self test 15

- 3 Functionality 16**
 - 3.1 Sensing element 16
 - 3.2 IC interface 16
 - 3.3 Factory calibration 17

- 4 Application hints 18**

- 5 Digital interface 19**
 - 5.1 SPI bus interface 19
 - 5.1.1 SPI Read 20
 - 5.1.2 SPI Write 21
 - 5.1.3 SPI Read in 3-wires mode 22

- 6 Register mapping 23**

- 7 Register description 25**
 - 7.1 WHO_AM_I (0Fh) 25
 - 7.2 OFFSET_X (16h) 25

7.3	OFFSET_Y (17h)	25
7.4	OFFSET_Z (18h)	26
7.5	GAIN_X (19h)	26
7.6	GAIN_Y (1Ah)	26
7.7	GAIN_Z (1Bh)	26
7.8	CTRL_REG1 (20h)	27
7.9	CTRL_REG2 (21h)	27
7.10	CTRL_REG3 (22h)	29
7.11	HP_FILTER_RESET (23h)	30
7.12	STATUS_REG (27h)	30
7.13	OUTX_L (28h)	30
7.14	OUTX_H (29h)	31
7.15	OUTY_L (2Ah)	31
7.16	OUTY_H (2Bh)	31
7.17	OUTZ_L (2Ch)	32
7.18	OUTZ_H (2Dh)	32
7.19	FF_WU_CFG (30h)	33
7.20	FF_WU_SRC (31h)	34
7.21	FF_WU_ACK (32h)	34
7.22	FF_WU_THS_L (34h)	34
7.23	FF_WU_THS_H (35h)	34
7.24	FF_WU_DURATION (36h)	36
7.25	DD_CFG (38h)	36
7.26	DD_SRC (39h)	37
7.27	DD_ACK (3Ah)	38
7.28	DD_THSI_L (3Ch)	38
7.29	DD_THSI_H (3Dh)	38
7.30	DD_THSE_L (3Eh)	38
7.31	DD_THSE_H (3Fh)	38
8	Typical performance characteristics	40
8.1	Mechanical characteristics at 25 °C	40
8.2	Mechanical characteristics at -40 °C	41

8.3	Mechanical characteristics at 105 °C	42
8.4	Mechanical characteristics derived from measurement in the -40 °C to +105 °C temperature range 43	
8.5	Electro-mechanical characteristics at 25 °C	44
8.6	Electrical characteristics at 25 °C	45
8.7	Electrical characteristics at -40 °C	45
8.8	Electrical characteristics at 105 °C	45
9	Soldering information	46
9.1	General guidelines about soldering surface mount accelerometer	46
9.2	PCB design guidelines	46
9.2.1	PCB design rules	47
9.3	Stencil design and solder paste application	47
9.4	Process consideration	48
10	Package information	49
11	Revision history	50

List of tables

Table 1.	Device summary	1
Table 2.	Pin description	6
Table 3.	Mechanical characteristics @ Vdd = 3.3 V, T = -40 °C to 105 °C unless otherwise noted.	7
Table 4.	Electrical characteristics @ Vdd=3.3 V, T = -40 °C to 105 °C unless otherwise noted	9
Table 5.	SPI slave timing values.	10
Table 6.	Absolute maximum ratings	11
Table 7.	Serial interface pin description	16
Table 8.	Registers address map.	20
Table 9.	Register	22
Table 10.	Register description	22
Table 11.	OFFSET_X register	22
Table 12.	OFFSET_X register description	22
Table 13.	OFFSET_Y register	22
Table 14.	OFFSET_Y register description	22
Table 15.	OFFSET_Z register	23
Table 16.	OFFSET_Z register description	23
Table 17.	GAIN_X register	23
Table 18.	GAIN_X register description	23
Table 19.	GAIN_Y register	23
Table 20.	GAIN_Y register description	23
Table 21.	GAIN_Z register	23
Table 22.	GAIN_Z register description	23
Table 23.	CTRL_REG1 register	24
Table 24.	CTRL_REG1 register description	24
Table 25.	CTRL_REG2 register	24
Table 26.	CTRL_REG2 register description	25
Table 27.	CTRL_REG3 register	26
Table 28.	CTRL_REG3 register description	26
Table 29.	STATUS_REG register.	27
Table 30.	STATUS_REG register description	27
Table 31.	OUTX_L register.	27
Table 32.	OUTX_L register description	27
Table 33.	OUTX_H register	28
Table 34.	OUTX_H register description	28
Table 35.	OUTY_L register.	28
Table 36.	OUTY_L register description	28
Table 37.	OUTY_H register	28
Table 38.	OUTY_H register description	28
Table 39.	OUTZ_L register.	29
Table 40.	OUTZ_L register description.	29
Table 41.	OUTZ_H register	29
Table 42.	OUTZ_H register description	29
Table 43.	FF_WU_CFG register.	30
Table 44.	FF_WU_CFG register description	30
Table 45.	FF_WU_SRC register.	31
Table 46.	FF_WU_SRC register description	31
Table 47.	FF_WU_THS_L register.	31
Table 48.	FF_WU_THS_L register description.	31

Table 49.	FF_WU_THS_H register	31
Table 50.	FF_WU_THS_H register description	31
Table 51.	FF_WU_DURATION register	32
Table 52.	FF_WU_DURATION register description	32
Table 53.	DD_CFG register	32
Table 54.	DD_CFG register description	32
Table 55.	DD_SRC register	33
Table 56.	DD_SRC register description	33
Table 57.	DD_THSI_L register	34
Table 58.	DD_THSI_L register description	34
Table 59.	DD_THSI_H register	34
Table 60.	DD_THSI_H register description	34
Table 61.	DD_THSE_L register	34
Table 62.	DD_THSE_L register description	34
Table 63.	DD_THSE_H register	34
Table 64.	DD_THSE_H register description	35
Table 65.	Document revision history	46

List of figures

Figure 1.	Block diagram	5
Figure 2.	Pin connection	5
Figure 3.	SPI slave timing diagram (2)	10
Figure 4.	AIS326DQ electrical connection	15
Figure 5.	Read and write protocol	16
Figure 6.	SPI read protocol	17
Figure 7.	Multiple bytes SPI read protocol (2 bytes example)	18
Figure 8.	SPI Write protocol	18
Figure 9.	Multiple bytes SPI write protocol (2 bytes example)	18
Figure 10.	SPI read protocol in 3-wires mode	19
Figure 11.	X-axis zero-g level at 3.3 V	36
Figure 12.	X-axis sensitivity at 3.3 V	36
Figure 13.	Y-axis zero-g level at 3.3 V	36
Figure 14.	Y-axis sensitivity at 3.3 V	36
Figure 15.	Z-axis zero-g level at 3.3 V	36
Figure 16.	Z-axis sensitivity at 3.3 V	36
Figure 17.	X-axis zero-g level at 3.3 V	37
Figure 18.	X-axis sensitivity at 3.3 V	37
Figure 19.	Y-axis zero-g level at 3.3 V	37
Figure 20.	Y-axis sensitivity at 3.3 V	37
Figure 21.	Z-axis zero-g level at 3.3 V	37
Figure 22.	Z-axis sensitivity at 3.3 V	37
Figure 23.	X-axis zero-g level at 3.3 V	38
Figure 24.	X-axis sensitivity at 3.3 V	38
Figure 25.	Y-axis zero-g level at 3.3 V	38
Figure 26.	Y-axis sensitivity at 3.3 V	38
Figure 27.	Z-axis zero-g level at 3.3 V	38
Figure 28.	Z-axis sensitivity at 3.3 V	38
Figure 29.	X-axis zero-g level change vs. temperature at 3.3 V	39
Figure 30.	X-axis sensitivity change vs. temperature at 3.3 V	39
Figure 31.	Y-axis zero-g level change vs. temperature at 3.3 V	39
Figure 32.	Y-axis sensitivity change vs. temperature at 3.3 V	39
Figure 33.	Z-axis zero-g level change vs. temperature at 3.3 V	39
Figure 34.	Z-axis sensitivity change vs. temperature at 3.3 V	39
Figure 35.	X and Y axes zero-g level as function of supply voltage	40
Figure 36.	X and Y axes sensitivity as function of supply voltage	40
Figure 37.	Z axis zero-g level as function of supply voltage	40
Figure 38.	Z axis sensitivity as function of supply voltage	40
Figure 39.	Current consumption in power-down mode (Vdd=3.3 V)	41
Figure 40.	Current consumption in operational mode (Vdd=3.3 V)	41
Figure 41.	Current consumption in power-down mode (Vdd=3.3 V)	41
Figure 42.	Current consumption in operational mode (Vdd=3.3 V)	41
Figure 43.	Current consumption in power-down mode (Vdd=3.3 V)	41
Figure 44.	Current consumption in operational mode (Vdd=3.3 V)	41
Figure 45.	Recommended land and solder mask design for QFPN packages	43
Figure 46.	QFPN-28 mechanical data and package dimensions	45

1 Block diagram and pin description

1.1 Block diagram

Figure 1. Block diagram

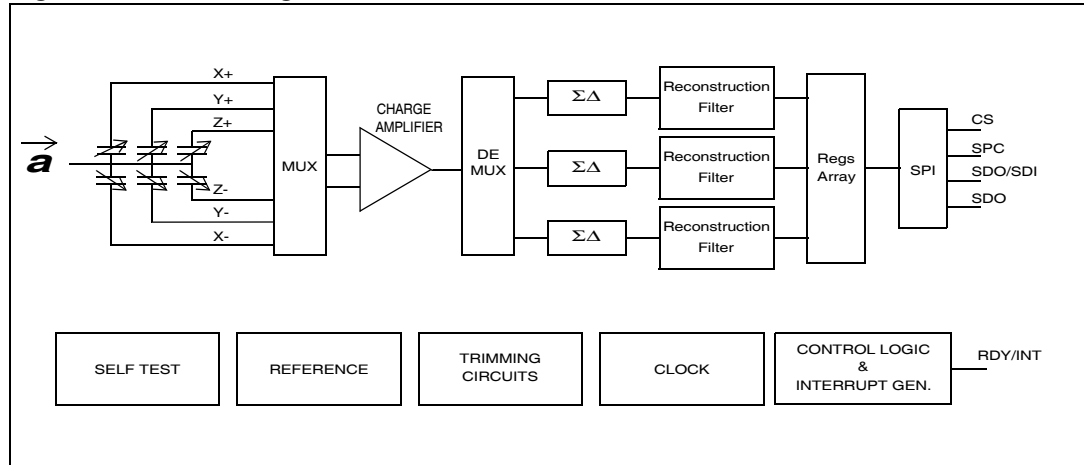

1.2 QFPN-28 pin description

Figure 2. Pin connection

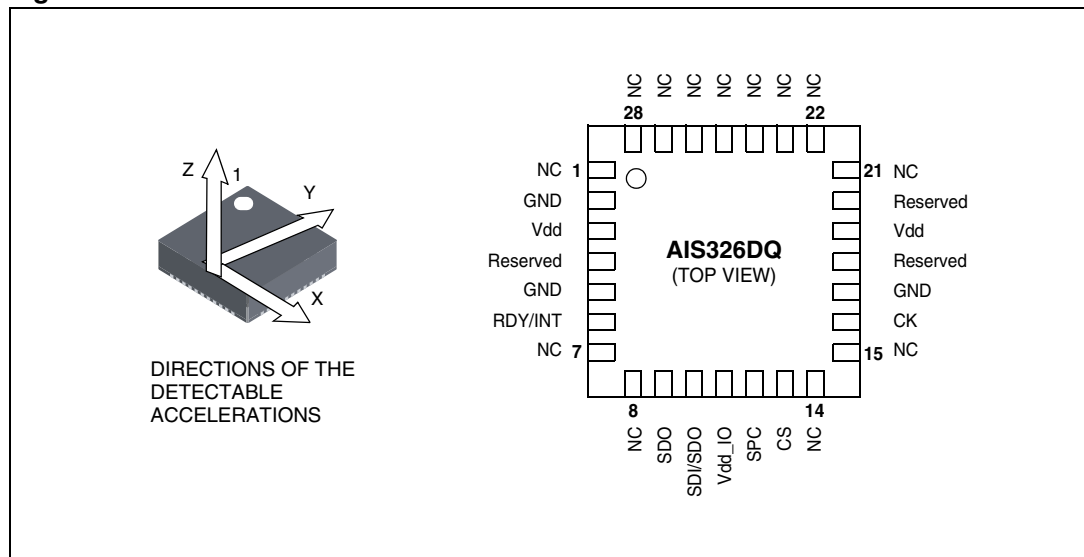

Table 2. Pin description

Pin#	Name	Function
1	NC	Internally not connected
2	GND	0 V supply
3	Vdd	Power supply
4	Reserved	Either leave unconnected or connect to GND
5	GND	0 V supply
6	RDY/INT	Data ready/inertial wake-up and free-fall interrupt
7, 8	NC	Internally not connected
9	SDO	SPI serial data output
10	SDI/ SDO	SPI serial data input (SDI) 3-wire interface serial data output (SDO)
11	Vdd_IO	Power supply for I/O pads
12	SPC	SPI serial port clock
13	CS	Chip select (logic 0: SPI enabled, logic 1: SPI disabled)
14, 15	NC	Internally not connected
16	CK	Optional external clock, if not used either leave unconnected or connect to GND
17	GND	0 V supply
18	Reserved	Either leave unconnected or connect to Vdd_IO
19	Vdd	Power supply
20	Reserved	Connect to Vdd
21 - 28	NC	Internally not connected

2 Mechanical and electrical specifications

2.1 Mechanical characteristics

Table 3. Mechanical characteristics @ Vdd = 3.3 V, T = -40 °C to 105 °C unless otherwise noted⁽¹⁾

Symbol	Parameter	Test conditions	Min.	Typ. ⁽²⁾	Max.	Unit
FS	Measurement range ⁽³⁾	FS bit set to 0	±1.7	±2.0		g
		FS bit set to 1	±5.3	±6.0		
Dres	Device resolution	Full-scale = ±2 g T = 25 °C, ODR1=40 Hz		1.0		mg
		Full-scale = ±2 g T = 25 °C, ODR2=160 Hz		2.0		
		Full-scale = ±2 g T = 25 °C, ODR3 = 640 Hz		3.9		
		Full-scale = ±2 g T = 25 °C, ODR4 = 2560 Hz		15.6		
So	Sensitivity	Full-scale = ±2 g 12 bit representation	952	1024	1096	LSb/g
		Full-scale = ±6 g 12 bit representation ⁽⁴⁾	316	340	364	
TCSO	Sensitivity change vs temperature	Full-scale = ±2 g 12 bit representation		0.025		%/°C
Off	Zero-g level offset accuracy ^{(5),(6)}	Full-scale = ±2 g X, Y axis	-100		100	mg
		Full-scale = ±2 g Z axis	-200		200	
		Full-scale = ±6 g X, Y axis ⁽⁴⁾	-100		100	
		Full-scale = ±6 g Z axis ⁽⁴⁾	-200		200	
TCOff	Zero-g level change vs temperature	Max delta from 25 °C		0.2		mg/°C
NL	Non linearity ⁽⁴⁾	Best fit straight line X, Y axis Full-scale = ±2 g ODR = 40 Hz		±2		% FS
		Best fit straight line Z axis Full-scale = ±2 g ODR = 40 Hz		±3		
CrAx	Cross axis ⁽⁴⁾		-5		5	%

Table 3. Mechanical characteristics @ Vdd = 3.3 V, T = -40 °C to 105 °C unless otherwise noted⁽¹⁾ (continued)

Symbol	Parameter	Test conditions	Min.	Typ. ⁽²⁾	Max.	Unit
V _{st}	Self-test output change ^{(7),(8)}	Full-scale= ±2 g X axis	200	460	750	LSb
		Full-scale= ±2 g Y axis	200	460	750	
		Full-scale= ±2 g Z axis	140	360	580	
		Full-scale= ±6 g X axis	60	160	260	LSb
		Full-scale= ±6 g Y axis	60	160	260	
		Full-scale= ±6 g Z axis	45	120	200	
BW	System bandwidth ⁽⁹⁾			ODRx/4		Hz
T _{OP}	Operating temperature range		-40		+105	°C
Wh	Product weight			0.2		gram

1. The product is factory calibrated at 3.3 V. Operation over 3.6 V is not recommended
2. Typical specifications are not guaranteed
3. Verified by wafer level test and specification of initial offset and sensitivity
4. Guaranteed by design
5. Zero-g level offset value after MSL3 preconditioning
6. Offset can be eliminated by enabling the built-in high pass filter (HPF)
7. Self test output changes with the power supply. "Self-test output change" is defined as $OUTPUT[LSb]_{(Self-test\ bit\ on\ CTRL_REG1=1)} - OUTPUT[LSb]_{(Self-test\ bit\ on\ CTRL_REG1=0)}$. 1LSb = 1g/1024 at 12 bit representation, 2 g Full-scale
8. Output data reach 99% of final value after 5/ODR when enabling Self-test mode due to device filtering
9. ODRx is output data rate. Refer to [Table 4](#) for specifications

2.2 Electrical characteristics

Table 4. Electrical characteristics @ Vdd=3.3 V, T = -40 °C to 105 °C unless otherwise noted⁽¹⁾

Symbol	Parameter	Test conditions	Min.	Typ. ⁽²⁾	Max.	Unit
Vdd	Supply voltage		3.0	3.3	3.6	V
Vdd_IO	I/O pads supply voltage ⁽³⁾		1.71		Vdd	V
Idd	Supply current	Vdd = 3.3 V		0.67	0.80	mA
IddPdn	Current consumption in power-down mode			2	20	µA
VIH	Digital high level Input voltage ⁽³⁾		0.8*Vdd_IO			V
VIL	Digital low level Input voltage ⁽³⁾				0.2*Vdd_IO	
VOH	High level output voltage ⁽³⁾		0.9*Vdd_IO			V
VOL	Low level output voltage ⁽³⁾				0.1*Vdd_IO	
ODR1	Output data rate 1	Dec factor = 512		40		Hz
ODR2	Output data rate 2	Dec factor = 128		160		
ODR3	Output data rate 3	Dec factor = 32		640		
ODR4	Output data rate 4	Dec factor = 8		2560		
BW	System bandwidth ⁽⁴⁾			ODRx/4		Hz
Ton	Turn-on time ⁽⁵⁾			5/ODRx		s
T _{OP}	Operating temperature range		-40		+105	°C

1. The product is factory calibrated at 3.3 V. Operation over 3.6 V is not recommended
2. Typical specifications are not guaranteed
3. Guaranteed by design
4. Digital filter -3 dB frequency
5. Time to obtain valid data after exiting power-down mode

2.3 Communication interface characteristics

2.3.1 SPI - serial peripheral interface

Subject to general operating conditions for V_{DD} and T_{OP}

Table 5. SPI slave timing values

Symbol	Parameter	Value ⁽¹⁾		Unit
		Min	Max	
tc(SPC)	SPI clock cycle	125		ns
fc(SPC)	SPI clock frequency		8	MHz
tsu(CS)	CS setup time	5		ns
th(CS)	CS hold time	10		
tsu(SI)	SDI input setup time	5		
th(SI)	SDI input hold time	15		
tv(SO)	SDO valid output time		55	
th(SO)	SDO output hold time	7		
t _{dis} (SO)	SDO output disable time		50	

1. Values are guaranteed at 8 MHz clock frequency for SPI with both 4 and 3 wires, based on characterization results, not tested in production

Figure 3. SPI slave timing diagram ⁽²⁾

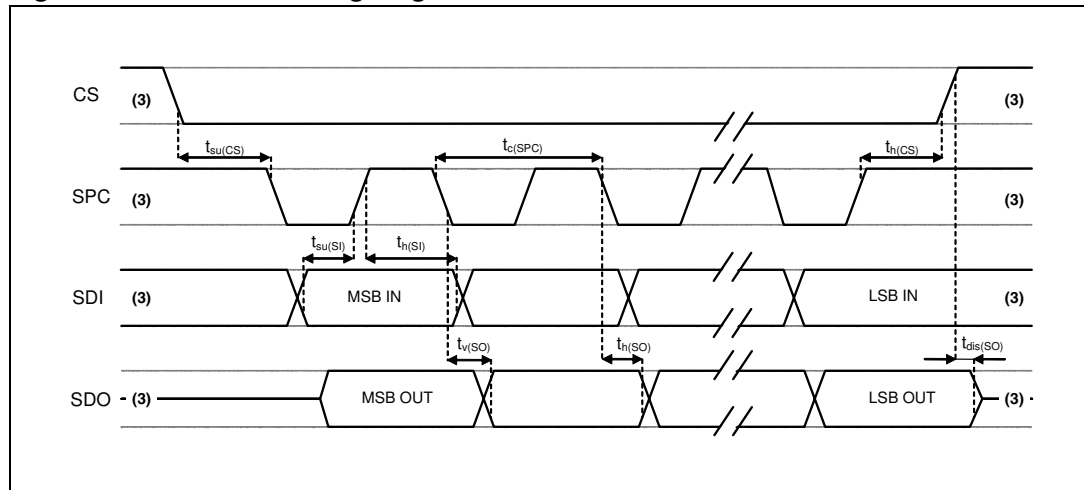

- 2. Measurement points are done at 0.2·V_{DD_IO} and 0.8·V_{DD_IO}, for both input and output port
- 3. When no communication is on-going, data on CS, SPC, SDI and SDO are driven by internal pull-up resistors

2.4 Absolute maximum ratings

Stresses above those listed as “absolute maximum ratings” may cause permanent damage to the device. This is a stress rating only and functional operation of the device under these conditions is not implied. Exposure to maximum rating conditions for extended periods may affect device reliability.

Table 6. Absolute maximum ratings

Symbol	Ratings	Maximum value	Unit
V _{DD}	Supply voltage ⁽¹⁾	-0.3 to 6.0	V
V _{DD_IO}	I/O pins supply voltage ⁽¹⁾	-0.3 to V _{DD} +0.1	V
V _{IN}	Input voltage on any control pin ⁽¹⁾ (CS, SPC, SDI/SDO, SDO, CK)	-0.3 to V _{DD_IO} +0.3	V
A _{POW}	Acceleration (any axis, powered, V _{DD} = 3.3 V)	3000 g for 0.5 ms	
		10000 g for 0.1 ms	
A _{UNP}	Acceleration (any axis, unpowered)	3000 g for 0.5 ms	
		10000 g for 0.1 ms	
T _{OP}	Operating temperature range	-40 to +105	°C
T _{STG}	Storage temperature range	-40 to +125	°C
ESD	Electrostatic discharge protection	4.0 (HBM)	kV
		200 (MM)	V
		1.5 (CDM)	kV

1. Supply voltage on any pin should never exceed 6.0 V.



This is a mechanical shock sensitive device, improper handling can cause permanent damages to the part.



This is an ESD sensitive device, improper handling can cause permanent damages to the part.

2.5 Terminology

2.5.1 Sensitivity

Sensitivity describes the gain of the sensor and can be determined e.g. by applying 1 *g* acceleration to it. As the sensor can measure DC accelerations this can be done easily by pointing the axis of interest towards the center of the earth, noting the output value, rotating the sensor by 180 degrees (point to the sky) and noting the output value again. By doing so, ± 1 *g* acceleration is applied to the sensor. Subtracting the larger output value from the smaller one, and dividing the result by 2, leads to the actual sensitivity of the sensor. This value changes very little over temperature and also very little over time. The Sensitivity tolerance describes the range of sensitivities of a large population of sensors.

2.5.2 Zero-g level

Zero-*g* level offset (Off) describes the deviation of an actual output signal from the ideal output signal if there is no acceleration present. A sensor in a steady state on a horizontal surface will measure 0 *g* in X axis and 0 *g* in Y axis whereas the Z axis will measure 1 *g*. The output is ideally in the middle of the dynamic range of the sensor (content of OUT registers 00h, 00h with 16 bit representation, data expressed as 2's complement number). A deviation from ideal value in this case is called Zero-*g* offset. Offset is to some extent a result of stress to a precise MEMS sensor and therefore the offset can slightly change after mounting the sensor onto a printed circuit board or exposing it to extensive mechanical stress. Offset changes little over temperature, see "Zero-*g* level change vs. temperature". The Zero-*g* level of an individual sensor is stable over lifetime. The Zero-*g* level tolerance describes the range of Zero-*g* levels of a population of sensors.

2.5.3 Self test

Self test allows to test the mechanical and electric part of the sensor, allowing the seismic mass to be moved by means of an electrostatic test-force. The self-test function is off when the self-test bit of CTRL_REG1 (control register 1) is programmed to '0'. When the self-test bit of CTRL_REG1 is programmed to '1' an actuation force is applied to the sensor, simulating a definite input acceleration. In this case the sensor outputs will exhibit a change in their DC levels which is related to the selected full scale and depending on the Supply Voltage through the device sensitivity. When Self Test is activated, the device output level is given by the algebraic sum of the signals produced by the acceleration acting on the sensor and by the electrostatic test-force. If the output signals change within the amplitude specified inside [Table 3](#) or [4](#) then the sensor is working properly and the parameters of the interface chip are within the defined specification.

3 Functionality

The AIS326DQ is a high performance, low-power, digital output 3-axes linear accelerometer packaged in a QFN package. The complete device includes a sensing element and an IC interface able to take the information from the sensing element and to provide a signal to the external world through an SPI serial interface.

3.1 Sensing element

A proprietary process is used to create a surface micro-machined accelerometer. The technology allows to carry out suspended silicon structures which are attached to the substrate in a few points called anchors and are free to move in the direction of the sensed acceleration. To be compatible with the traditional packaging techniques a cap is placed on top of the sensing element to avoid blocking the moving parts during the moulding phase of the plastic encapsulation.

When an acceleration is applied to the sensor the proof mass displaces from its nominal position, causing an imbalance in the capacitive half-bridge. This imbalance is measured using charge integration in response to a voltage pulse applied to the sense capacitor.

At steady state the nominal value of the capacitors are few pF and when an acceleration is applied the maximum variation of the capacitive load is up to 100 pF.

3.2 IC interface

The complete measurement chain is composed by a low-noise capacitive amplifier which converts into an analog voltage the capacitive unbalancing of the MEMS sensor and by three $\Sigma\Delta$ analog-to-digital converters, one for each axis, that translate the produced signal into a digital bitstream.

The $\Sigma\Delta$ converters are coupled with dedicated reconstruction filters which remove the high frequency components of the quantization noise and provide low rate and high resolution digital words.

The charge amplifier and the $\Sigma\Delta$ converters are operated respectively at 61.5 kHz and 20.5 kHz.

The data rate at the output of the reconstruction depends on the user selected decimation factor (DF) and spans from 40 Hz to 2560 Hz.

The acceleration data may be accessed through an SPI interface thus making the device particularly suitable for direct interfacing with a microcontroller.

The AIS326DQ features a data-ready signal (RDY) which indicates when a new set of measured acceleration data is available thus simplifying data synchronization in digital system employing the device itself.

The AIS326DQ may also be configured to generate an inertial wake-up, direction detection and free-fall interrupt signal accordingly to a programmed acceleration event along the enabled axes.

3.3 Factory calibration

The IC interface is factory calibrated for sensitivity (So) and Zero-g level (Off).

The trimming values are stored inside the device by a non volatile structure. Any time the device is turned on, the trimming parameters are downloaded into the registers to be employed during the normal operation. This allows the user to employ the device without further calibration.

4 Application hints

Figure 4. AIS326DQ electrical connection

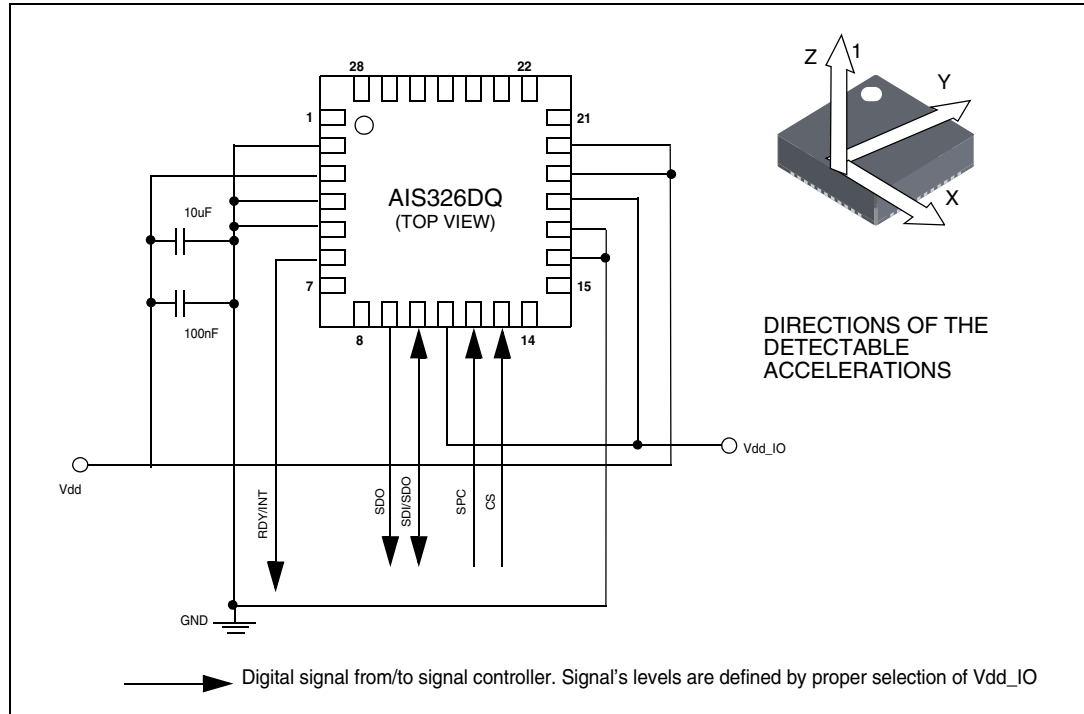

The device core is supplied through Vdd line while the I/O pads are supplied through Vdd_IO line. Power supply decoupling capacitors (100 nF ceramic, 10 µF Al) should be placed as near as possible to the pin 3 of the device (common design practice).

All the voltage and ground supplies must be present at the same time to have proper behavior of the IC (refer to [Figure 4](#)). It is possible to remove Vdd maintaining Vdd_IO without blocking the communication busses. In this condition the measurement chain is powered off.

The functionality of the device and the measured acceleration data is selectable and accessible through the SPI interface. The design of the application board should take in consideration that the AIS326DQ is equipped also with an I2C compatible interface that it is activated when the signal on CS pin is high (logic:1).

The functions, the thresholds and the timing of the interrupt pin (INT) can be completely programmed by the user through the SPI interface.

5 Digital interface

The registers embedded inside the AIS326DQ may be accessed through SPI serial interface. The latter may be SW configured to operate either in 3-wire or 4-wire interface mode.

Table 7. Serial interface pin description

Pin name	Pin description
CS	Chip select (logic 0: SPI enabled, logic 1: SPI disabled)
SPC	SPI serial port clock
SDI/SDO	SPI serial data input (SDI) 3-wire interface serial data output (SDO)
SDO	SPI serial data output (SDO)

The embedded registers may be accessed also through an I²C interface. For I²C operation refer to LIS3LV02DQ datasheet or contact ST technical support.

5.1 SPI bus interface

The AIS326DQ SPI is a bus slave. The SPI allows to write and read the registers of the device.

The serial interface interacts with the outside world with 4 wires: **CS**, **SPC**, **SDI** and **SDO**.

Figure 5. Read and write protocol

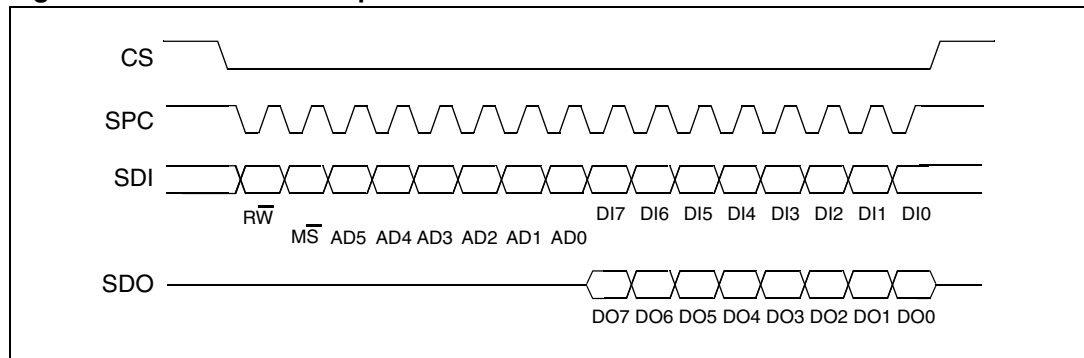

CS is the serial port enable and it is controlled by the SPI master. It goes low at the start of the transmission and goes back high at the end.

SPC is the Serial Port Clock and it is controlled by the SPI master. It is stopped high when **CS** is high (no transmission).

SDI and **SDO** are respectively the serial port data input and output. Those lines are driven at the falling edge of **SPC** and should be captured at the rising edge of **SPC**.

Both the read register and write register commands are completed in 16 clock pulses or in multiple of 8 in case of multiple byte read/write. Bit duration is the time between two falling edges of **SPC**. The first bit (bit 0) starts at the first falling edge of **SPC** after the falling edge

of **CS** while the last bit (bit 15, bit 23, ...) starts at the last falling edge of SPC just before the rising edge of **CS**.

bit 0: \overline{RW} bit. When 0, the data DI(7:0) is written into the device. When 1, the data DO(7:0) from the device is read. In latter case, the chip will drive **SDO** at the start of bit 8.

bit 1: \overline{MS} bit. When 0, the address will remain unchanged in multiple read/write commands. When 1, the address will be auto increased in multiple read/write commands.

bit 2-7: address AD(5:0). This is the address field of the indexed register.

bit 8-15: data DI(7:0) (write mode). This is the data that will be written into the device (MSb first).

bit 8-15: data DO(7:0) (read mode). This is the data that will be read from the device (MSb first).

In multiple read/write commands further blocks of 8 clock periods will be added. When \overline{MS} bit is 0 the address used to read/write data remains the same for every block. When \overline{MS} bit is '1' the address used to read/write data is increased at every block.

The function and the behavior of **SDI** and **SDO** remain unchanged.

5.1.1 SPI Read

Figure 6. SPI read protocol

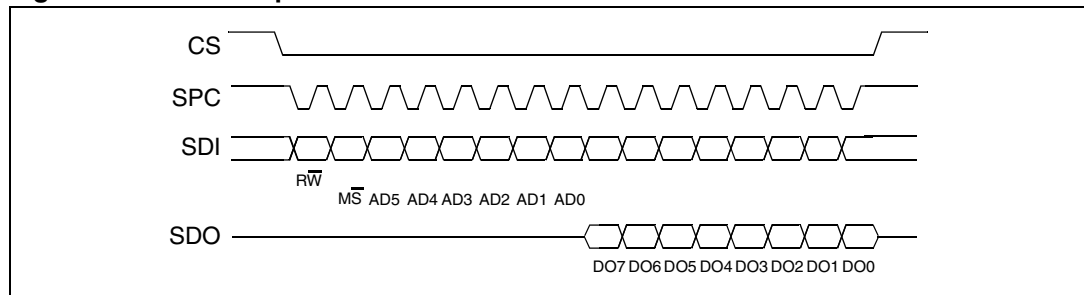

The SPI Read command is performed with 16 clock pulses. Multiple byte read command is performed adding blocks of 8 clock pulses at the previous one.

bit 0: READ bit. The value is 1.

bit 1: \overline{MS} bit. When 0 do not increment address, when 1 increment address in multiple reading.

bit 2-7: address AD(5:0). This is the address field of the indexed register.

bit 8-15: data DO(7:0) (read mode). This is the data that will be read from the device (MSb first).

bit 16-... : data DO(...-8). Further data in multiple byte reading.

Figure 7. Multiple bytes SPI read protocol (2 bytes example)

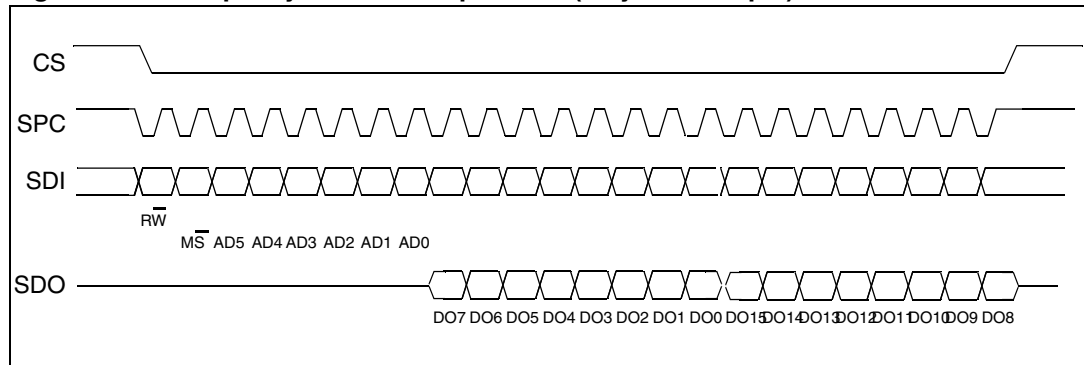

5.1.2 SPI Write

Figure 8. SPI Write protocol

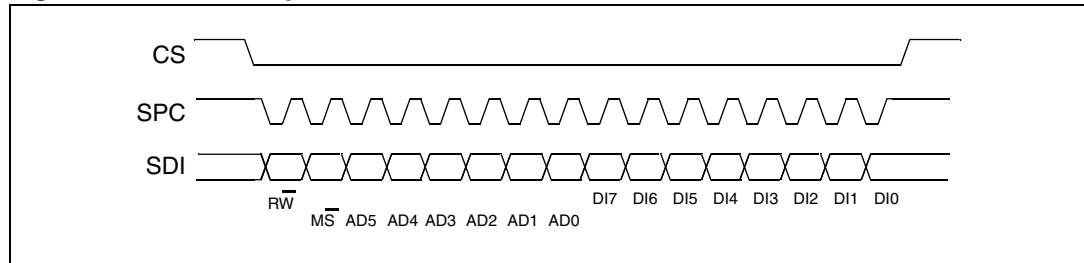

The SPI Write command is performed with 16 clock pulses. Multiple byte write command is performed adding blocks of 8 clock pulses at the previous one.

bit 0: WRITE bit. The value is 0.

bit 1: MS bit. When 0 do not increment address, when 1 increment address in multiple writing.

bit 2 -7: address AD(5:0). This is the address field of the indexed register.

bit 8-15: data DI(7:0) (write mode). This is the data that will be written inside the device (MSb first).

bit 16-... : data DI(...-8). Further data in multiple byte writing.

Figure 9. Multiple bytes SPI write protocol (2 bytes example)

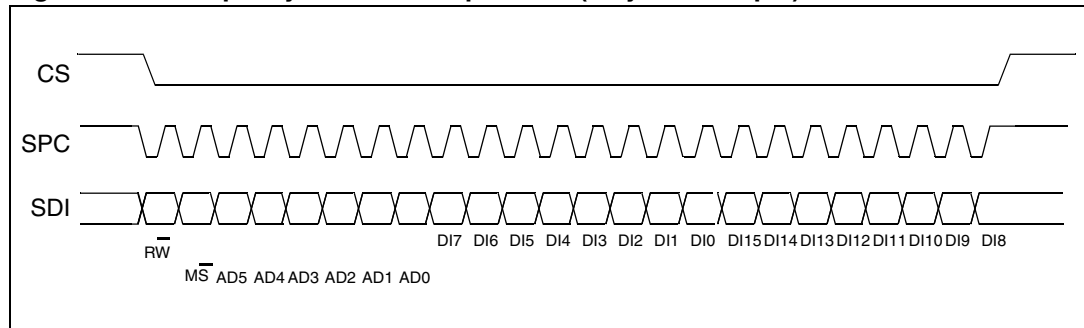

5.1.3 SPI Read in 3-wires mode

3-wires mode is entered by setting to '1' bit SIM (SPI serial interface mode selection) in CTRL_REG2.

Figure 10. SPI read protocol in 3-wires mode

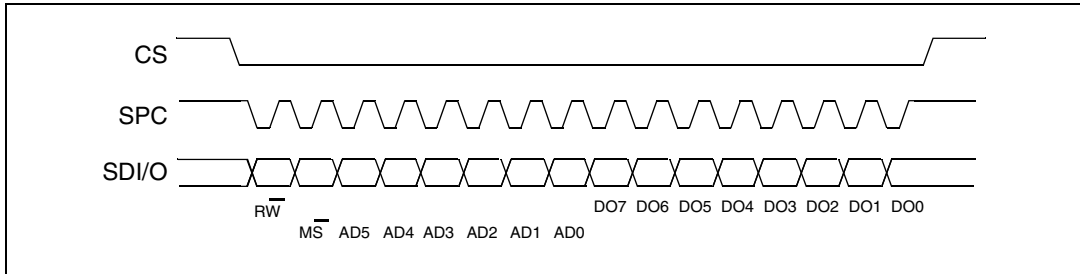

The SPI read command is performed with 16 clock pulses:

bit 0: READ bit. The value is 1.

bit 1: \overline{MS} bit. When 0 do not increment address, when 1 increment address in multiple reading.

bit 2-7: address AD(5:0). This is the address field of the indexed register.

bit 8-15: data DO(7:0) (read mode). This is the data that will be read from the device (MSb first).

Multiple read command is also available in 3-wires mode.

6 Register mapping

The table given below provides a listing of the 8 bit registers embedded in the device and the related address.

Table 8. Registers address map

Register name	Type	Register address		Default	Comment
		Binary	Hex		
	rw	0000000 - 0001110	00 - 0E		Reserved
WHO_AM_I	r	0001111	0F	00111010	Dummy register
	rw	0010000 - 0010101	10 - 15		Reserved
OFFSET_X	rw	0010110	16	Calibration	Loaded at boot
OFFSET_Y	rw	0010111	17	Calibration	Loaded at boot
OFFSET_Z	rw	0011000	18	Calibration	Loaded at boot
GAIN_X	rw	0011001	19	Calibration	Loaded at boot
GAIN_Y	rw	0011010	1A	Calibration	Loaded at boot
GAIN_Z	rw	0011011	1B	Calibration	Loaded at boot
		0011100 -0011111	1C-1F		Reserved
CTRL_REG1	rw	0100000	20	00000111	
CTRL_REG2	rw	0100001	21	00000000	
CTRL_REG3	rw	0100010	22	00001000	
HP_FILTER RESET	r	0100011	23	dummy	Dummy register
		0100100-0100110	24-26		Not used
STATUS_REG	rw	0100111	27	00000000	
OUTX_L	r	0101000	28	output	
OUTX_H	r	0101001	29	output	
OUTY_L	r	0101010	2A	output	
OUTY_H	r	0101011	2B	output	
OUTZ_L	r	0101100	2C	output	
OUTZ_H	r	0101101	2D	output	
	r	0101110	2E		Reserved
		0101111	2F		Not used
FF_WU_CFG	rw	0110000	30	00000000	
FF_WU_SRC	rw	0110001	31	00000000	
FF_WU_ACK	r	0110010	32	dummy	Dummy register
		0110011	33		Not used
FF_WU_THS_L	rw	0110100	34	00000000	

Table 8. Registers address map (continued)

Register name	Type	Register address		Default	Comment
		Binary	Hex		
FF_WU_THS_H	rw	0110101	35	00000000	
FF_WU_DURATION	rw	0110110	36	00000000	
		0110111	37		Not used
DD_CFG	rw	0111000	38	00000000	
DD_SRC	rw	0111001	39	00000000	
DD_ACK	r	0111010	3A	dummy	Dummy register
		0111011	3B		Not used
DD_THSI_L	rw	0111100	3C	00000000	
DD_THSI_H	rw	0111101	3D	00000000	
DD_THSE_L	rw	0111110	3E	00000000	
DD_THSE_H	rw	0111111	3F	00000000	
		1000000-1111111	40-7F		Reserved

Registers marked as *Reserved* must not be changed. The writing to those registers may cause permanent damages to the device.

The content of the registers that are loaded at boot should not be changed. They contain the factory calibration values. Their content is automatically restored when the device is powered up.

7 Register description

The device contains a set of registers which are used to control its behavior and to retrieve acceleration data. The registers 7.2 to 7.7 contain the factory calibration values, it is not necessary to change their value for normal device operation.

7.1 WHO_AM_I (0Fh)

Table 9. Register

W7	W6	W5	W4	W3	W2	W1	W0
----	----	----	----	----	----	----	----

Table 10. Register description

W7, W0	AIS326DQ physical address equal to 3Ah
--------	--

Addressing this register the physical address of the device is returned. For AIS326DQ the physical address assigned in factory is 3Ah.

7.2 OFFSET_X (16h)

Table 11. OFFSET_X register

OX7	OX6	OX5	OX4	OX3	OX2	OX1	OX0
-----	-----	-----	-----	-----	-----	-----	-----

Table 12. OFFSET_X register description

OX7, OX0	Digital offset trimming for X-Axis
----------	------------------------------------

7.3 OFFSET_Y (17h)

Table 13. OFFSET_Y register

OY7	OY6	OY5	OY4	OY3	OY2	OY1	OY0
-----	-----	-----	-----	-----	-----	-----	-----

Table 14. OFFSET_Y register description

OY7, OY0	Digital offset trimming for Y-Axis
----------	------------------------------------

7.4 OFFSET_Z (18h)

Table 15. OFFSET_Z register

OZ7	OZ6	OZ5	OZ4	OZ3	OZ2	OZ1	OZ0
-----	-----	-----	-----	-----	-----	-----	-----

Table 16. OFFSET_Z register description

OZ7, OZ0	Digital offset trimming for Z-Axis
----------	------------------------------------

7.5 GAIN_X (19h)

Table 17. GAIN_X register

GX7	GX6	GX5	GX4	GX3	GX2	GX1	GX0
-----	-----	-----	-----	-----	-----	-----	-----

Table 18. GAIN_X register description

GX7, GX0	Digital gain trimming for X-Axis
----------	----------------------------------

7.6 GAIN_Y (1Ah)

Table 19. GAIN_Y register

GY7	GY6	GY5	GY4	GY3	GY2	GY1	GY0
-----	-----	-----	-----	-----	-----	-----	-----

Table 20. GAIN_Y register description

GY7, GY0	Digital gain trimming for Y-Axis
----------	----------------------------------

7.7 GAIN_Z (1Bh)

Table 21. GAIN_Z register

GZ7	GZ6	GZ5	GZ4	GZ3	GZ2	GZ1	GZ0
-----	-----	-----	-----	-----	-----	-----	-----

Table 22. GAIN_Z register description

GZ7, GZ0	Digital gain trimming for Z-Axis
----------	----------------------------------

7.8 CTRL_REG1 (20h)

Table 23. CTRL_REG1 register

PD1	PD0	DF1	DF0	ST	Zen	Yen	Xen
-----	-----	-----	-----	----	-----	-----	-----

Table 24. CTRL_REG1 register description

PD1, PD0	Power down control (00: power-down mode; 01, 10, 11: device on)
DF1, DF0	Decimation factor control (00: decimate by 512; 01: decimate by 128; 10: decimate by 32; 11: decimate by 8)
ST	Self test enable (0: normal mode; 1: self-test active)
Zen	Z-axis enable (0: axis off; 1: axis on)
Yen	Y-axis enable (0: axis off; 1: axis on)
Xen	X-axis enable (0: axis off; 1: axis on)

PD1, PD0 bit allows to turn the device out of power-down mode. The device is in power-down mode when PD1, PD0= "00" (default value after boot). The device is in normal mode when either PD1 or PD0 is set to 1.

DF1, DF0 bit allows to select the data rate at which acceleration samples are produced. The default value is "00" which corresponds to a data-rate of 40 Hz. By changing the content of DF1, DF0 to "01", "10" and "11" the selected data-rate will be set respectively equal to 160 Hz, 640 Hz and to 2560 Hz.

ST bit is used to activate the self test function. When the bit is set to one, an output change will occur to the device outputs (refer to table 2 and 3 for specification) thus allowing to check the functionality of the whole measurement chain.

Zen bit enables the Z-axis measurement channel when set to 1. The default value is 1.

Yen bit enables the Y-axis measurement channel when set to 1. The default value is 1.

Xen bit enables the X-axis measurement channel when set to 1. The default value is 1.

7.9 CTRL_REG2 (21h)

Table 25. CTRL_REG2 register

FS	BDU	BLE	BOOT	IEN	DRDY	SIM	DAS
----	-----	-----	------	-----	------	-----	-----

Table 26. CTRL_REG2 register description

FS	Full scale selection (0: $\pm 2 g$; 1: $\pm 6 g$)
BDU	Block data update (0: continuous update; 1: output registers not updated between MSB and LSB reading)
BLE	Big/little endian selection (0: little endian; 1: big endian)
BOOT	Reboot memory content
IEN	Interrupt ENable (0: data ready on RDY pad; 1: interrupt events on RDY pad)
DRDY	Enable data-ready generation
SIM	SPI serial interface mode selection (0: 4-wire interface; 1: 3-wire interface)
DAS	Data alignment selection (0: 12 bit right justified; 1: 16 bit left justified)

FS bit is used to select full scale value. After the device power-up the default full scale value is $\pm 2 g$. In order to obtain a $\pm 6 g$ full scale it is necessary to set FS bit to '1'.

BDU bit is used to inhibit output registers update between the reading of upper and lower register parts. In default mode (BDU = '0') the lower and upper register parts are updated continuously. If it is not sure to read faster than output data rate, it is recommended to set BDU bit to '1'. In this way, after the reading of the lower (upper) register part, the content of that output registers is not updated until the upper (lower) part is read too. This feature avoids reading LSB and MSB related to different samples.

BLE bit is used to select Big Endian or Little Endian representation for output registers. In Big Endian's one MSB acceleration value is located at addresses 28h (X-axis), 2Ah (Y-axis) and 2Ch (Z-axis) while LSB acceleration value is located at addresses 29h (X-axis), 2Bh (Y-axis) and 2Dh (Z-axis). In Little Endian representation (Default, BLE='0') the order is inverted (refer to data register description for more details).

BOOT bit is used to refresh the content of internal registers stored in the flash memory block. At the device power up the content of the flash memory block is transferred to the internal registers related to trimming functions to permit a good behavior of the device itself. If for any reason the content of trimming registers was changed it is sufficient to use this bit to restore correct values. When BOOT bit is set to '1' the content of internal flash is copied inside corresponding internal registers and it is used to calibrate the device. These values are factory trimmed and they are different for every accelerometer. They permit a good behavior of the device and normally they have not to be changed. At the end of the boot process the BOOT bit is set again to '0'.

IEN bit is used to switch the value present on data-ready pad between Data-Ready signal and Interrupt signal. At power up the Data-ready signal is chosen. It is however necessary to modify DRDY bit to enable Data-Ready signal generation.

DRDY bit is used to enable Data-Ready (RDY/INT) pin activation. If DRDY bit is '0' (default value) on Data-Ready pad a '0' value is present. If a Data-Ready signal is desired it is necessary to set to '1' DRDY bit. Data-Ready signal goes to '1' whenever a new data is available for all the enabled axis. For example if Z-axis is disabled, Data-Ready signal goes to '1' when new values are available for both X and Y axis. Data-Ready signal comes back to '0' when all the registers containing values of the enabled axis are read. To be sure not to lose any data coming from the accelerometer data registers must be read before a new Data-Ready rising edge is generated. In this case Data-ready signal will have the same frequency of the data rate chosen.

SIM bit selects the SPI Serial Interface Mode. When SIM is '0' (default value) the 4-wire interface mode is selected. The data coming from the device are sent to SDO pad. In 3-wire interface mode output data are sent to SDA/SDI pad.

DAS bit permits to decide between 12 bit right justified and 16 bit left justified representation of data coming from the device. The first case is the default case and the most significant bits are replaced by the bit representing the sign.

7.10 CTRL_REG3 (22h)

Table 27. CTRL_REG3 register

ECK	HPDD	HPFF	FDS	res	res	CFS1	CFS0
-----	------	------	-----	-----	-----	------	------

Table 28. CTRL_REG3 register description

ECK	External Clock. Default value: 0 (0: clock from internal oscillator; 1: clock from external pad)
HPDD	High Pass filter enabled for Direction Detection. Default value: 0 (0: filter bypassed; 1: filter enabled)
HPFF	High Pass filter enabled for Free-Fall and Wake-Up. Default value: 0 (0: filter bypassed; 1: filter enabled)
FDS	Filtered Data Selection. Default value: 0 (0: internal filter bypassed; 1: data from internal filter)
CFS1, CFS0	High-pass filter Cut-off Frequency Selection. Default value: 00 (00: Hpc=512 01: Hpc=1024 10: Hpc=2048 11: Hpc=4096)

FDS bit enables (FDS=1) or bypass (FDS=0) the high pass filter in the signal chain of the sensor.

CFS1, CFS0 bits defines the coefficient H_{pc} to be used to calculate the -3dB cut-off frequency of the high pass filter:

$$f_{\text{cutoff}} = \frac{0.318}{H_{pc}} \cdot \frac{ODR_x}{2}$$

7.11 HP_FILTER_RESET (23h)

Dummy register. Reading at this address zeroes instantaneously the content of the internal high pass-filter. Read data is not significant.

7.12 STATUS_REG (27h)

Table 29. STATUS_REG register

ZYXOR	ZOR	YOR	XOR	ZYXDA	ZDA	YDA	XDA
-------	-----	-----	-----	-------	-----	-----	-----

Table 30. STATUS_REG register description

ZYXOR	X, Y and Z axis data overrun
ZOR	Z axis data overrun
YOR	Y axis data overrun
XOR	X axis data overrun
ZYXDA	X, Y and Z axis new data available
ZDA	Z axis new data available
YDA	Y axis new data available
XDA	X axis new data available

The content of this register is updated every ODR cycle, regardless of BDU bit value in CTRL_REG2.

7.13 OUTX_L (28h)

Table 31. OUTX_L register

XD7	XD6	XD5	XD4	XD3	XD2	XD1	XD0
-----	-----	-----	-----	-----	-----	-----	-----

Table 32. OUTX_L register description

XD7, XD0	X axis acceleration data LSB
----------	------------------------------

In big endian mode (bit BLE in CTRL_REG2 set to '1') the content of this register is the MSB acceleration data and depends on bit DAS in CTRL_REG2 register as described in the following section.

7.14 OUTX_H (29h)

Table 33. OUTX_H register

XD15	XD14	XD13	XD12	XD11	XD10	XD9	XD8
------	------	------	------	------	------	-----	-----

Table 34. OUTX_H register description

XD15, XD8	X axis acceleration data MSB
-----------	------------------------------

When reading the register in "12 bit right justified" mode the most significant bits (15:12) are replaced with bit 11 (i.e. XD15-XD12=XD11, XD11, XD11, XD11).

In big endian mode (bit BLE in CTRL_REG2 set to '1') the content of this register is the LSB acceleration data.

7.15 OUTY_L (2Ah)

Table 35. OUTY_L register

YD7	YD6	YD5	YD4	YD3	YD2	YD1	YD0
-----	-----	-----	-----	-----	-----	-----	-----

Table 36. OUTY_L register description

YD7, YD0	Y axis acceleration data LSB
----------	------------------------------

In big endian mode (bit BLE in CTRL_REG2 set to '1') the content of this register is the MSB acceleration data and depends on bit DAS in CTRL_REG2 register as described in the following section.

7.16 OUTY_H (2Bh)

Table 37. OUTY_H register

YD15	YD14	YD13	YD12	YD11	YD10	YD9	YD8
------	------	------	------	------	------	-----	-----

Table 38. OUTY_H register description

YD15, YD8	Y axis acceleration data MSB
-----------	------------------------------

When reading the register in “12 bit right justified” mode the most significant bits (15:12) are replaced with bit 11 (i.e. YD15-YD12=YD11, YD11, YD11, YD11).

In big endian mode (bit BLE in CTRL_REG2 set to ‘1’) the content of this register is the LSB acceleration data.

7.17 OUTZ_L (2Ch)

Table 39. OUTZ_L register

ZD7	ZD6	ZD5	ZD4	ZD3	ZD2	ZD1	ZD0
-----	-----	-----	-----	-----	-----	-----	-----

Table 40. OUTZ_L register description

ZD7, ZD0	Z axis acceleration data LSB
----------	------------------------------

In big endian mode (bit BLE in CTRL_REG2 set to ‘1’) the content of this register is the MSB acceleration data and depends on bit DAS in CTRL_REG2 register as described in the following section.

7.18 OUTZ_H (2Dh)

Table 41. OUTZ_H register

ZD15	ZD14	ZD13	ZD12	ZD11	ZD10	ZD9	ZD8
------	------	------	------	------	------	-----	-----

Table 42. OUTZ_H register description

ZD15, ZD8	Z axis acceleration data MSB
-----------	------------------------------

When reading the register in “12 bit right justified” mode the most significant bits (15:12) are replaced with bit 11 (i.e. ZD15-ZD12=ZD11, ZD11, ZD11, ZD11).

In big endian mode (bit BLE in CTRL_REG2 set to ‘1’) the content of this register is the LSB acceleration data.

7.19 FF_WU_CFG (30h)

Table 43. FF_WU_CFG register

AOI	LIR	ZHIE	ZLIE	YHIE	YLIE	XHIE	XLIE
-----	-----	------	------	------	------	------	------

Table 44. FF_WU_CFG register description

AOI	And/Or combination of Interrupt events. Default value: 0. (0: OR combination of interrupt events; 1: AND combination of interrupt events)
LIR	Latch interrupt request. Default value: 0. (0: interrupt request not latched; 1: interrupt request latched)
ZHIE	Enable Interrupt request on Z High event. Default value: 0. (0: disable interrupt request; 1: enable interrupt request on measured accel. value higher than preset threshold)
ZLIE	Enable Interrupt request on Z Low event. Default value: 0. (0: disable interrupt request; 1: enable interrupt request on measured accel. value lower than preset threshold)
YHIE	Enable Interrupt request on Y High event. Default value: 0. (0: disable interrupt request; 1: enable interrupt request on measured accel. value higher than preset threshold)
YLIE	Enable Interrupt request on Y Low event. Default value: 0. (0: disable interrupt request; 1: enable interrupt request on measured accel. value lower than preset threshold)
XHIE	Enable Interrupt request on X High event. Default value: 0. (0: disable interrupt request; 1: enable interrupt request on measured accel. value higher than preset threshold)
XLIE	Enable Interrupt request on X Low event. Default value: 0. (0: disable interrupt request; 1: enable interrupt request on measured accel. value lower than preset threshold)

Free-fall and inertial wake-up configuration register.

7.20 FF_WU_SRC (31h)

Table 45. FF_WU_SRC register

X	IA	ZH	ZL	YH	YL	XH	XL
---	----	----	----	----	----	----	----

Table 46. FF_WU_SRC register description

IA	Interrupt Active. Default value: 0 (0: no interrupt has been generated; 1: one or more interrupt events have been generated)
ZH	Z High. Default value: 0 (0: no interrupt; 1: Z High event has occurred)
ZL	Z Low. Default value: 0 (0: no interrupt; 1: Z Low event has occurred)
YH	Y High. Default value: 0 (0: no interrupt; 1: Y High event has occurred)
YL	Y Low. Default value: 0 (0: no interrupt; 1: Y Low event has occurred)
XH	X High. Default value: 0 (0: no interrupt; 1: X High event has occurred)
XL	X Low. Default value: 0 (0: no interrupt; 1: X Low event has occurred)

7.21 FF_WU_ACK (32h)

Dummy register. If LIR bit in FF_WU_CFG register is set to '1', a reading at this address refreshes the FF_WU_SRC register. Read data is not significant.

7.22 FF_WU_THS_L (34h)

Table 47. FF_WU_THS_L register

THS7	THS6	THS5	THS4	THS3	THS2	THS1	THS0
------	------	------	------	------	------	------	------

Table 48. FF_WU_THS_L register description

THS7, THS0	Free-fall / inertial wake up acceleration threshold LSB
------------	---

7.23 FF_WU_THS_H (35h)

Table 49. FF_WU_THS_H register

THS15	THS14	THS13	THS12	THS11	THS10	THS9	THS8
-------	-------	-------	-------	-------	-------	------	------

Table 50. FF_WU_THS_H register description

THS15, THS8	Free-fall / inertial wake up acceleration threshold MSB
-------------	---

7.24 FF_WU_DURATION (36h)

Table 51. FF_WU_DURATION register

FWD7	FWD6	FWD5	FWD4	FWD3	FWD2	FWD1	FWD0
------	------	------	------	------	------	------	------

Table 52. FF_WU_DURATION register description

FWD7, FWD0	Minimum duration of the Free-fall/Wake-up event
------------	---

This register sets the minimum duration of the free-fall/wake-up event to be recognized.

$$\text{Duration(s)} = \frac{\text{FF_WU_DURATION (Dec)}}{\text{ODR}}$$

7.25 DD_CFG (38h)

Table 53. DD_CFG register

IEND	LIR	ZHIE	ZLIE	YHIE	YLIE	XHIE	XLIE
------	-----	------	------	------	------	------	------

Table 54. DD_CFG register description

IEND	Interrupt enable on direction change. Default value: 0 (0: disabled; 1: interrupt signal enabled)
LIR	Latch Interrupt request into DD_SRC reg with the DD_SRC reg cleared by reading DD_ACK reg. Default value: 0. (0: interrupt request not latched; 1: interrupt request latched)
ZHIE	Enable interrupt generation on Z high event. Default value: 0 (0: disable interrupt request; 1: enable interrupt request on measured accel. value higher than preset threshold)
ZLIE	Enable interrupt generation on Z low event. Default value: 0 (0: disable interrupt request; 1: enable interrupt request on measured accel. value lower than preset threshold)
YHIE	Enable interrupt generation on Y high event. Default value: 0 (0: disable interrupt request; 1: enable interrupt request on measured accel. value higher than preset threshold)

Table 54. DD_CFG register description (continued)

YLIE	Enable interrupt generation on Y low event. Default value: 0 (0: disable interrupt request; 1: enable interrupt request on measured accel. value lower than preset threshold)
XHIE	Enable interrupt generation on X high event. Default value: 0 (0: disable interrupt request; 1: enable interrupt request on measured accel. value higher than preset threshold)
XLIE	Enable interrupt generation on X low event. Default value: 0 (0: disable interrupt request; 1: enable interrupt request on measured accel. value lower than preset threshold)

Direction-detector configuration register.

7.26 DD_SRC (39h)

Table 55. DD_SRC register

X	IA	ZH	ZL	YH	YL	XH	XL
---	----	----	----	----	----	----	----

Table 56. DD_SRC register description

IA	Interrupt event from direction change. (0: no direction changes detected; 1: direction has changed from previous measurement)
ZH	Z High. Default value: 0 (0: Z below THSI threshold; 1: Z accel. exceeding THSE threshold along positive direction of acceleration axis)
ZL	Z Low. Default value: 0 (0: Z below THSI threshold; 1: Z accel. exceeding THSE threshold along negative direction of acceleration axis)
YH	Y High. Default value: 0 (0: Y below THSI threshold; 1: Y accel. exceeding THSE threshold along positive direction of acceleration axis)
YL	Y Low. Default value: 0 (0: Y below THSI threshold; 1: Y accel. exceeding THSE threshold along negative direction of acceleration axis)
XH	X High. Default value: 0 (0: X below THSI threshold; 1: X accel. exceeding THSE threshold along positive direction of acceleration axis)
XL	X Low. Default value: 0 (0: X below THSI threshold; 1: X accel. exceeding THSE threshold along negative direction of acceleration axis)

Direction detector source register.

7.27 DD_ACK (3Ah)

Dummy register. If LIR bit in DD_CFG register is set to '1', a reading at this address refreshes the DD_SRC register. Read data is not significant.

7.28 DD_THSI_L (3Ch)

Table 57. DD_THSI_L register

THSI7	THSI6	THSI5	THSI4	THSI3	THSI2	THSI1	THSI0
-------	-------	-------	-------	-------	-------	-------	-------

Table 58. DD_THSI_L register description

THSI7, THSI0	Direction detection internal threshold LSB
--------------	--

7.29 DD_THSI_H (3Dh)

Table 59. DD_THSI_H register

THSI15	THSI14	THSI13	THSI12	THSI11	THSI10	THSI9	THSI8
--------	--------	--------	--------	--------	--------	-------	-------

Table 60. DD_THSI_H register description

THSI15, THSI8	Direction detection internal threshold MSB
---------------	--

7.30 DD_THSE_L (3Eh)

Table 61. DD_THSE_L register

THSE7	THSE6	THSE5	THSE4	THSE3	THSE2	THSE1	THSE0
-------	-------	-------	-------	-------	-------	-------	-------

Table 62. DD_THSE_L register description

THSE7, THSE0	Direction detection external threshold LSB
--------------	--

7.31 DD_THSE_H (3Fh)

Table 63. DD_THSE_H register

THSE15	THSE14	THSE13	THSE12	THSE11	THSE10	THSE9	THSE8
--------	--------	--------	--------	--------	--------	-------	-------

Table 64. DD_THSE_H register description

THSE15, THSE8	Direction detection external threshold MSB
---------------	--

8 Typical performance characteristics

8.1 Mechanical characteristics at 25 °C

Figure 11. X-axis zero-g level at 3.3 V

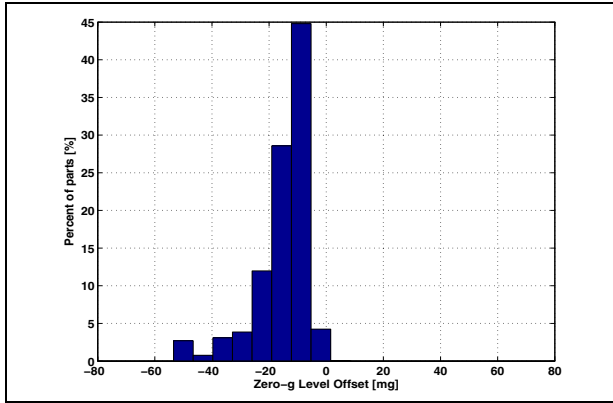

Figure 12. X-axis sensitivity at 3.3 V

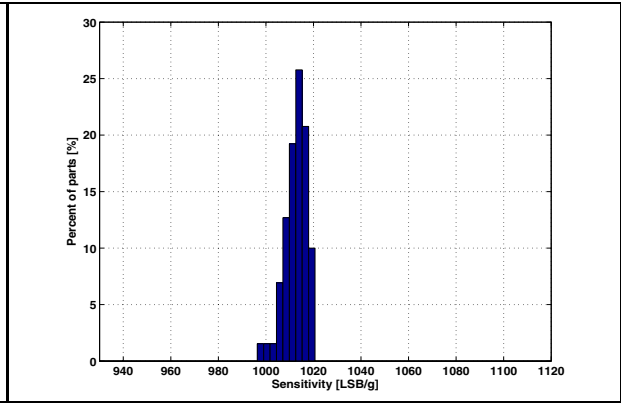

Figure 13. Y-axis zero-g level at 3.3 V

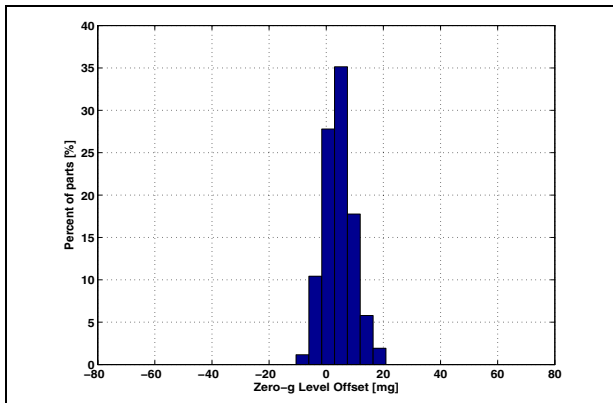

Figure 14. Y-axis sensitivity at 3.3 V

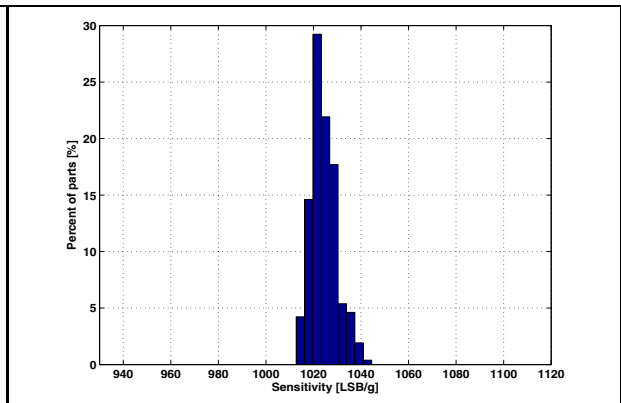

Figure 15. Z-axis zero-g level at 3.3 V

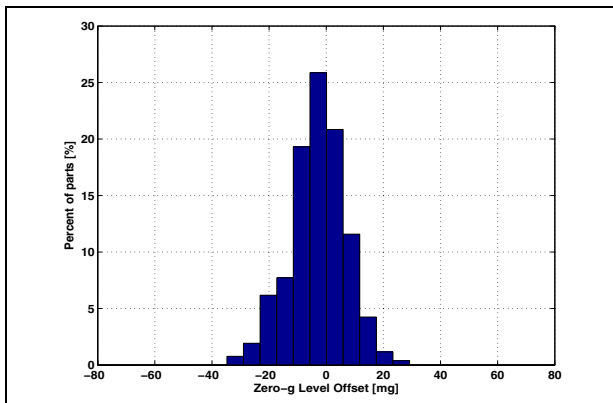
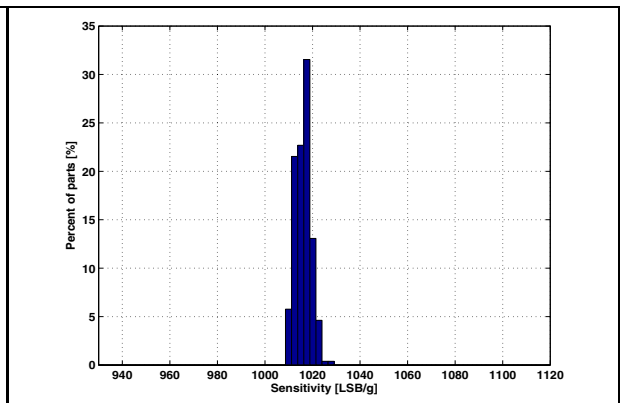

Figure 16. Z-axis sensitivity at 3.3 V



8.2 Mechanical characteristics at -40 °C

Figure 17. X-axis zero-g level at 3.3 V

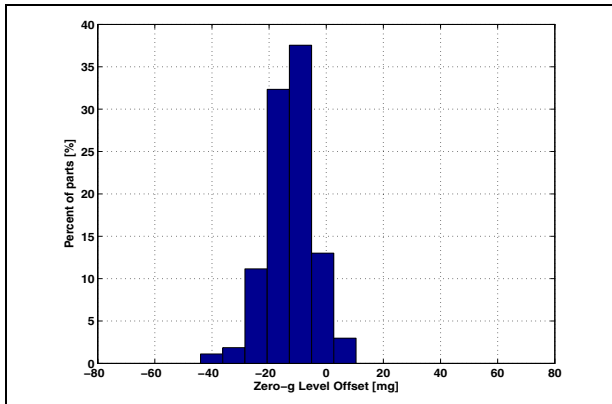

Figure 18. X-axis sensitivity at 3.3 V

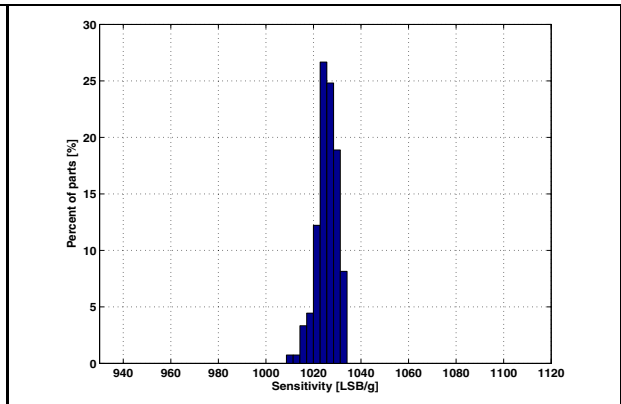

Figure 19. Y-axis zero-g level at 3.3 V

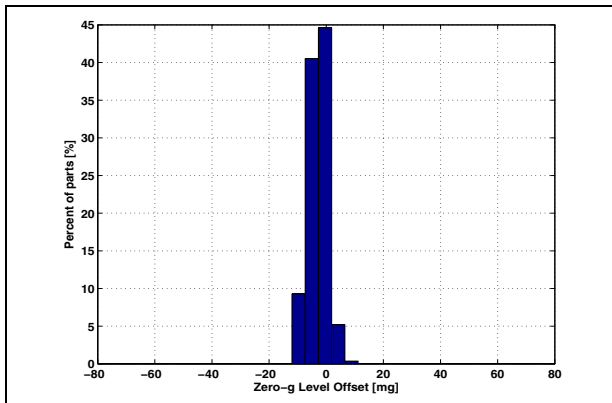

Figure 20. Y-axis sensitivity at 3.3 V

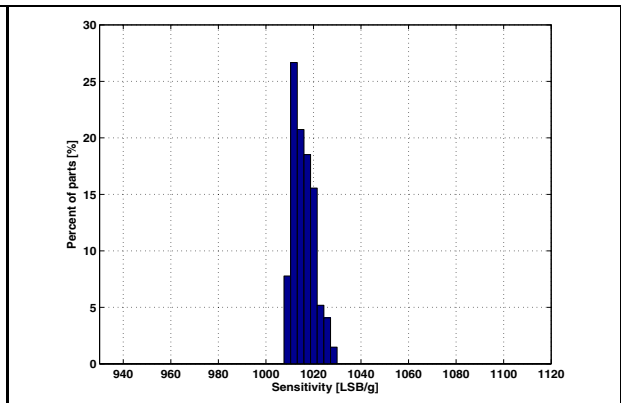

Figure 21. Z-axis zero-g level at 3.3 V

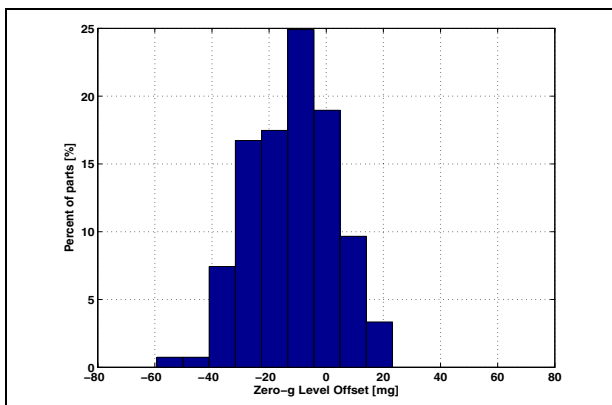
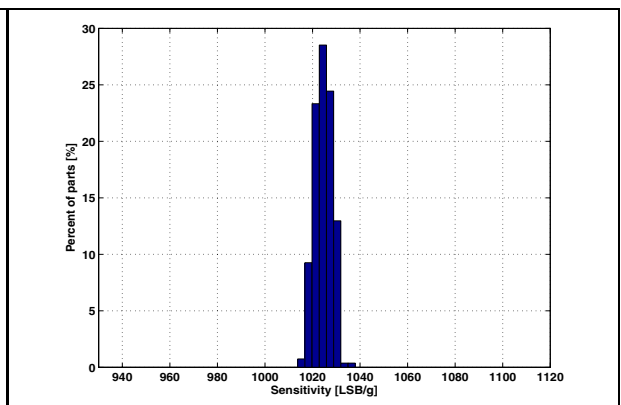

Figure 22. Z-axis sensitivity at 3.3 V



8.3 Mechanical characteristics at 105 °C

Figure 23. X-axis zero-g level at 3.3 V

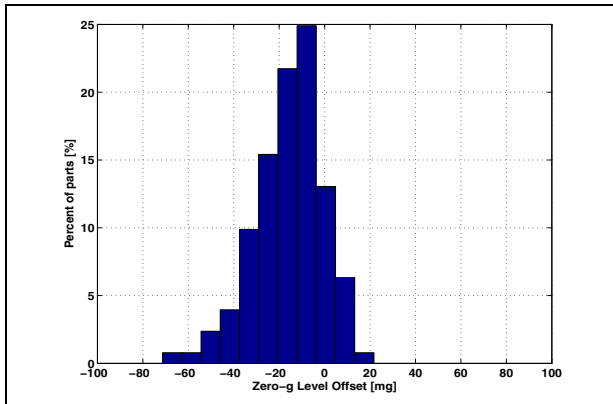

Figure 24. X-axis sensitivity at 3.3 V

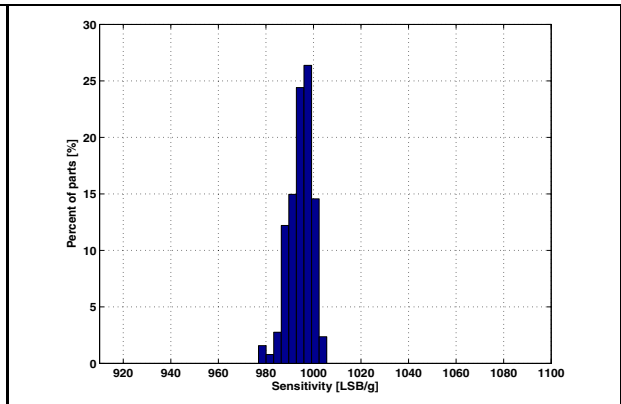

Figure 25. Y-axis zero-g level at 3.3 V

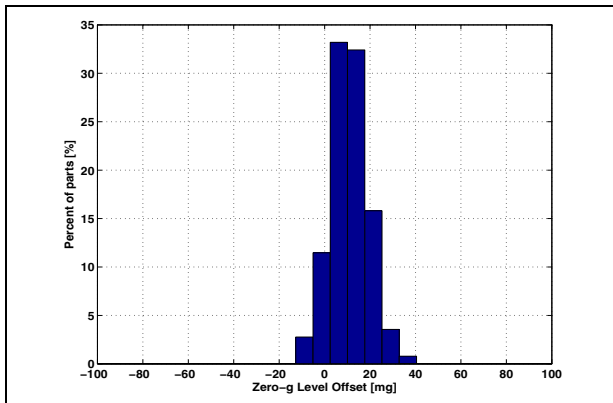

Figure 26. Y-axis sensitivity at 3.3 V

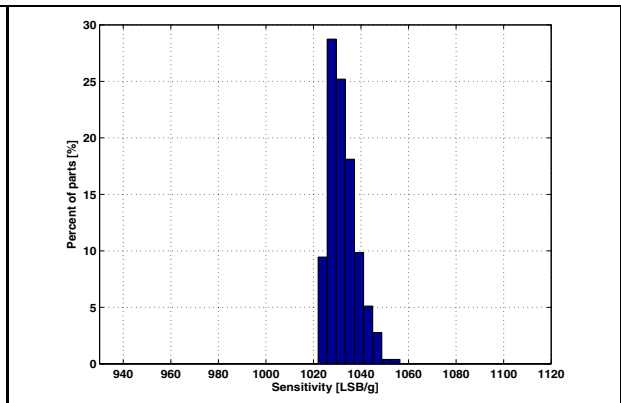

Figure 27. Z-axis zero-g level at 3.3 V

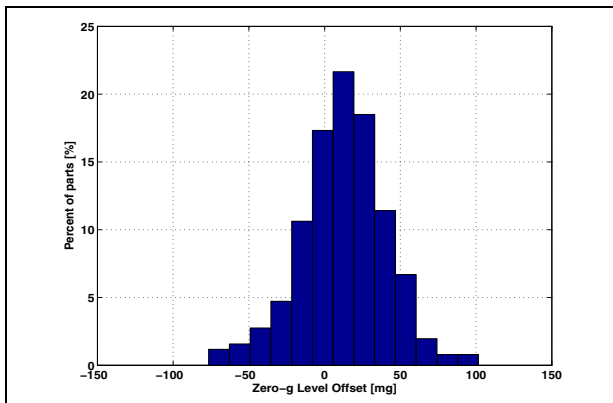
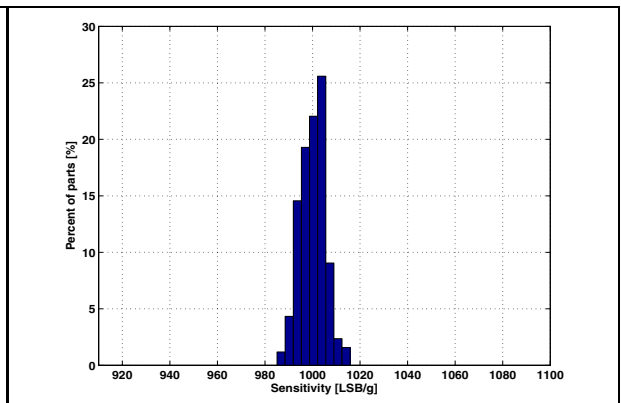

Figure 28. Z-axis sensitivity at 3.3 V



8.4 Mechanical characteristics derived from measurement in the -40 °C to +105 °C temperature range

Figure 29. X-axis zero-g level change vs. temperature at 3.3 V

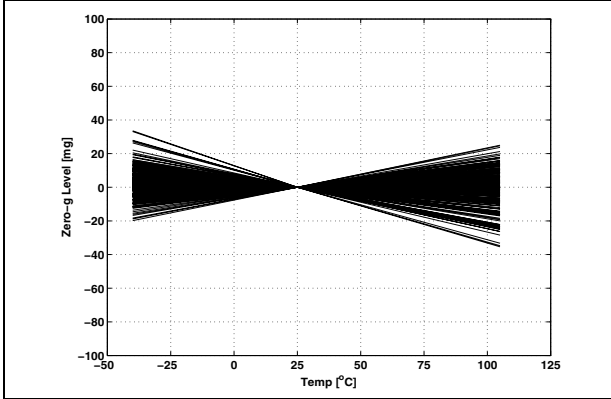

Figure 30. X-axis sensitivity change vs. temperature at 3.3 V

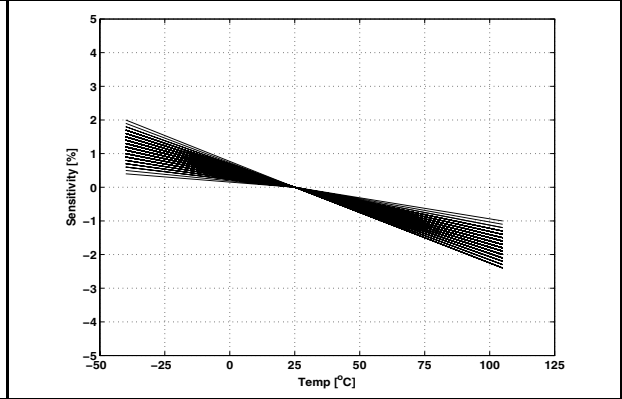

Figure 31. Y-axis zero-g level change vs. temperature at 3.3 V

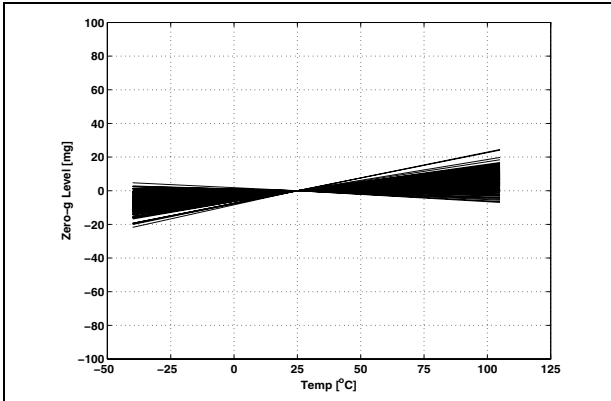

Figure 32. Y-axis sensitivity change vs. temperature at 3.3 V

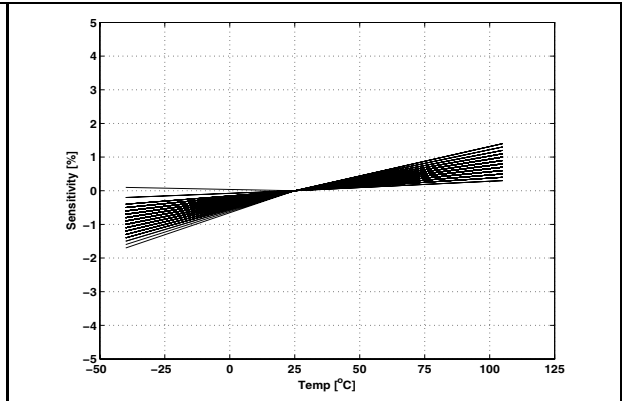

Figure 33. Z-axis zero-g level change vs. temperature at 3.3 V

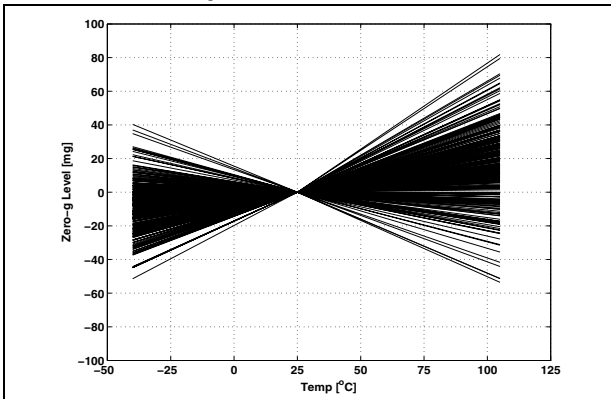
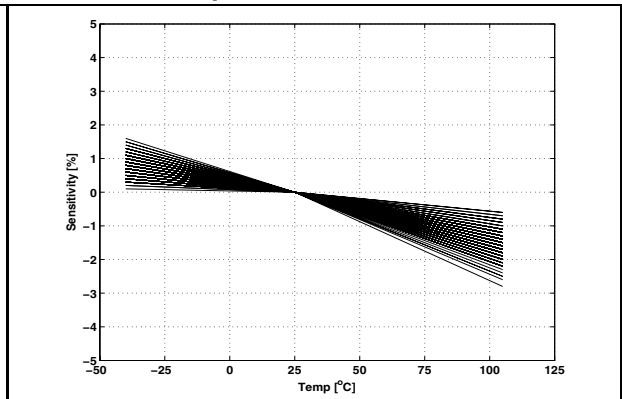

Figure 34. Z-axis sensitivity change vs. temperature at 3.3 V



8.5 Electro-mechanical characteristics at 25 °C

Figure 35. X and Y axes zero-g level as function of supply voltage

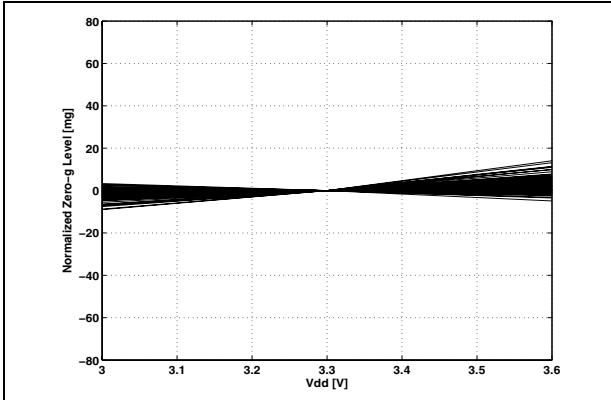

Figure 36. X and Y axes sensitivity as function of supply voltage

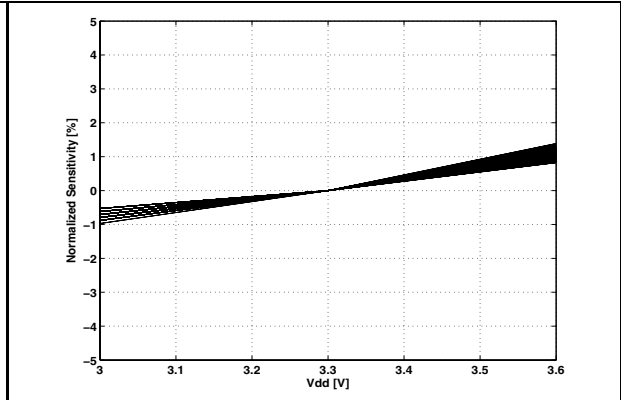

Figure 37. Z axis zero-g level as function of supply voltage

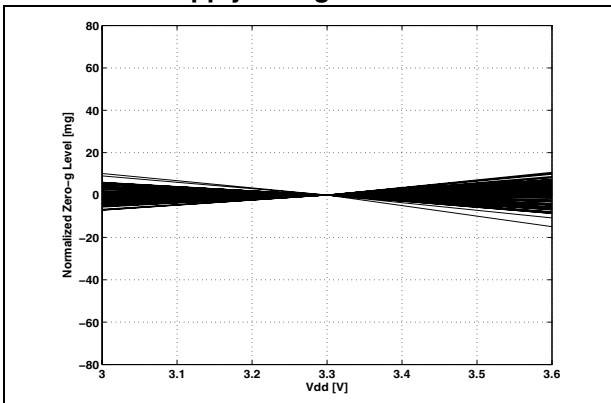
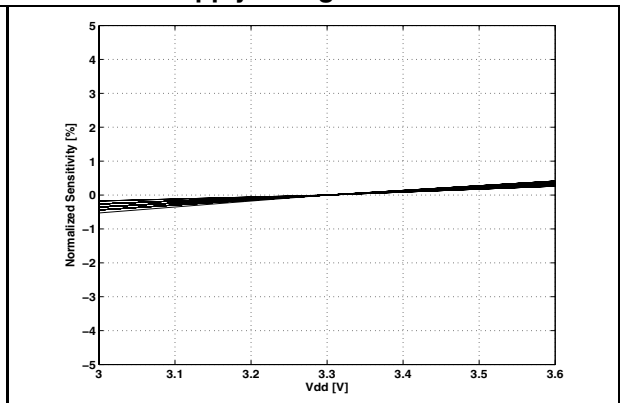

Figure 38. Z axis sensitivity as function of supply voltage



8.6 Electrical characteristics at 25 °C

Figure 39. Current consumption in power-down mode (Vdd=3.3 V)

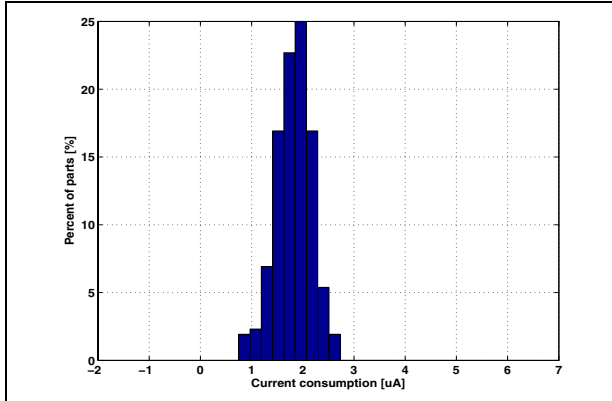
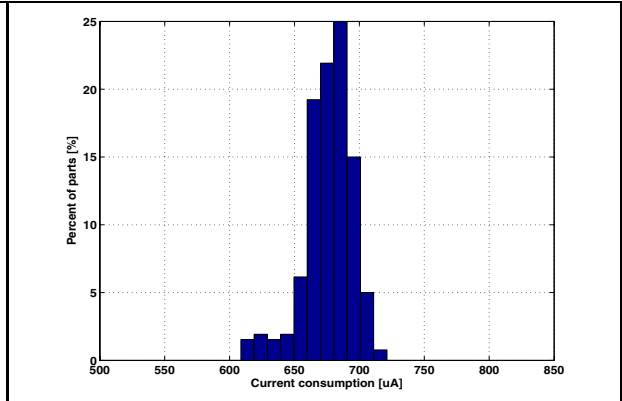

Figure 40. Current consumption in operational mode (Vdd=3.3 V)



8.7 Electrical characteristics at -40 °C

Figure 41. Current consumption in power-down mode (Vdd=3.3 V)

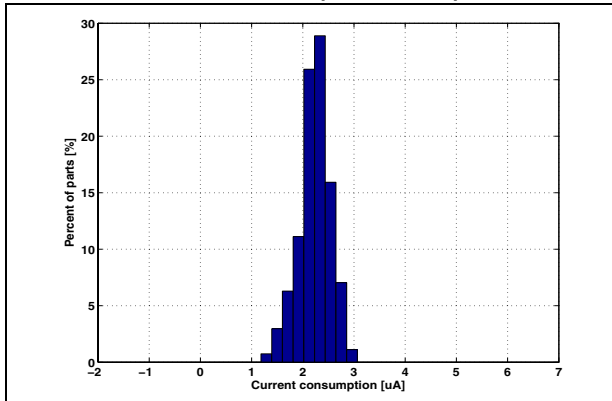
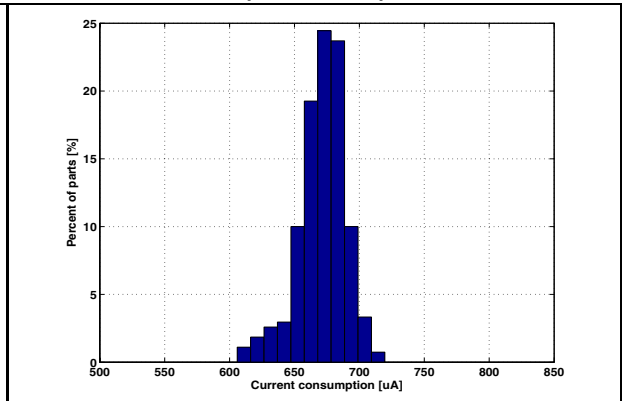

Figure 42. Current consumption in operational mode (Vdd=3.3 V)



8.8 Electrical characteristics at 105 °C

Figure 43. Current consumption in power-down mode (Vdd=3.3 V)

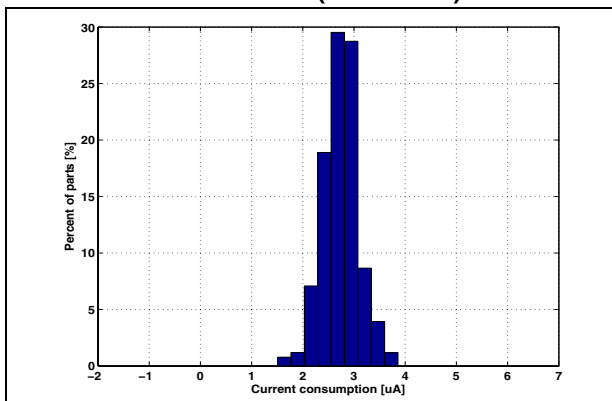
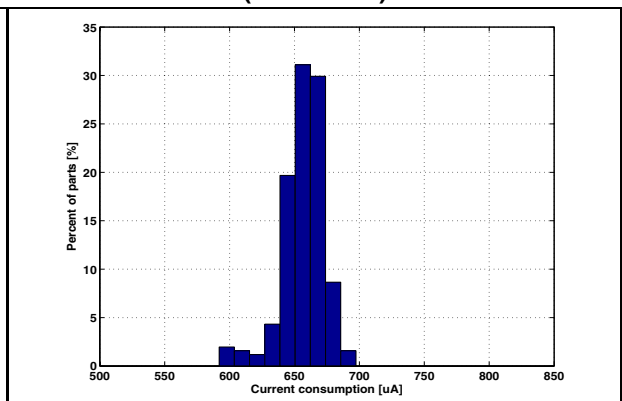

Figure 44. Current consumption in operational mode (Vdd=3.3 V)



9 Soldering information

The QFPN-28 package is compliant with the ECOPACK[®], RoHS and “Green” standard. It is qualified for soldering heat resistance according to JEDEC J-STD-020C, in MSL3 condition.

Land pattern and soldering recommendations are also available at www.st.com/.

9.1 General guidelines about soldering surface mount accelerometer

As common PCB design and industrial practice when considering accelerometer soldering, there are always 3 elements to take into consideration:

1. PCB with its own conductive layers (i.e. copper) and other organic materials used for board protection and dielectric isolation.
2. ACCELEROMETER to be mounted on the board. Accelerometer senses acceleration, but it senses also the mechanical stress coming from the board. This stress is minimized with simple PCB design rules.
3. SOLDERING PASTE like SnAgCu. This soldering paste can be dispensed on the board with a screen printing method through a stencil. The pattern of the soldering paste on the PCB is given by the stencil mask itself.

9.2 PCB design guidelines

PCB land and solder masking general recommendations are shown in [Figure 45](#). Refer to [Figure 46](#) for specific device size, land count and pitch.

- It is recommended to open solder mask external to PCB land;
- It is mandatory, for correct device functionality, that some clearance is ensured to be present between accelerometer thermal pad and PCB. In order to obtain this clearance it is recommended to open the PCB thermal pad solder mask;
- The area below the sensor (on the same side of the board) must be defined as keep-out area. It is strongly recommended not to place any structure in top metal layer underneath the sensor;
- Traces connected to pads should be as much symmetric as possible. Symmetry and balance for pad connection will help component self alignment and will lead to a better control of solder paste reduction after reflow;
- For better performances over temperature it is strongly recommended not to place large insertion components like buttons or shielding boxes at distance less than 2 mm from the sensor;
- Central die pad and “Pin 1 Indicator” are physically connected to GND. Leave “Pin 1 Indicator” unconnected during soldering.

9.2.1 PCB design rules

Figure 45. Recommended land and solder mask design for QFPN packages

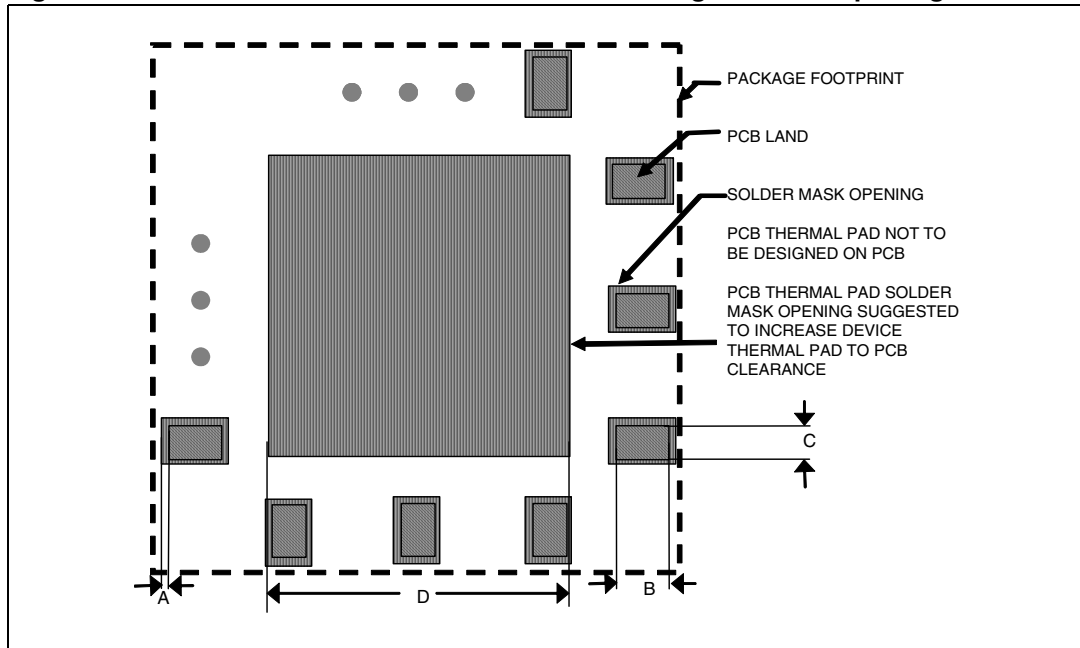

A = Clearance from PCB land edge to solder mask opening ≤ 0.1 mm to ensure that some solder mask remains between PCB pads

B = PCB land length = QFPN solder pad length + 0.1 mm

C = PCB land width = QFPN solder pad width + 0.1 mm

D = PCB thermal pad solder mask opening = QFPN thermal pad side + 0.2 mm

9.3 Stencil design and solder paste application

The thickness and the pattern of the soldering paste are important for the proper accelerometer mounting process.

- Stainless steel stencils are recommended for solder paste application
- A stencil thickness of 125 - 150 μm (5 - 6 mils) is recommended for screen printing
- The final thickness of soldering paste should allow proper cleaning of flux residuals and clearance between sensor package and PCB
- Stencil aperture should have rectangular shape with dimension up to 25 μm (1 mil) smaller than PCB land
- The openings of the stencil for the signal pads should be between 50% and 80% of the PCB pad area
- Optionally, for better solder paste release, the aperture walls should be trapezoidal and the corners rounded
- The fine pitch of the IC leads requires accurate alignment of the stencil to the printed circuit board. The stencil and printed circuit assembly should be aligned to within 25 μm (1 mil) prior to application of the solder paste.

9.4 Process consideration

- In case of use of no self-cleaning solder paste it is mandatory proper washing of the board after soldering to eliminate any possible source of leakage between adjacent pads due to flux residues
- The PCB soldering profile depends on the number, size and placement of components in the application board. It is not functional to define a specific soldering profile for the accelerometer only. Customer should use a time and temperature reflow profile that is derived from the PCB design and manufacturing experience.

10 Package information

In order to meet environmental requirements, ST offers these devices in different grades of ECOPACK[®] packages, depending on their level of environmental compliance. ECOPACK[®] specifications, grade definitions and product status are available at: www.st.com. ECOPACK[®] is an ST trademark.

Figure 46. QFPN-28 mechanical data and package dimensions

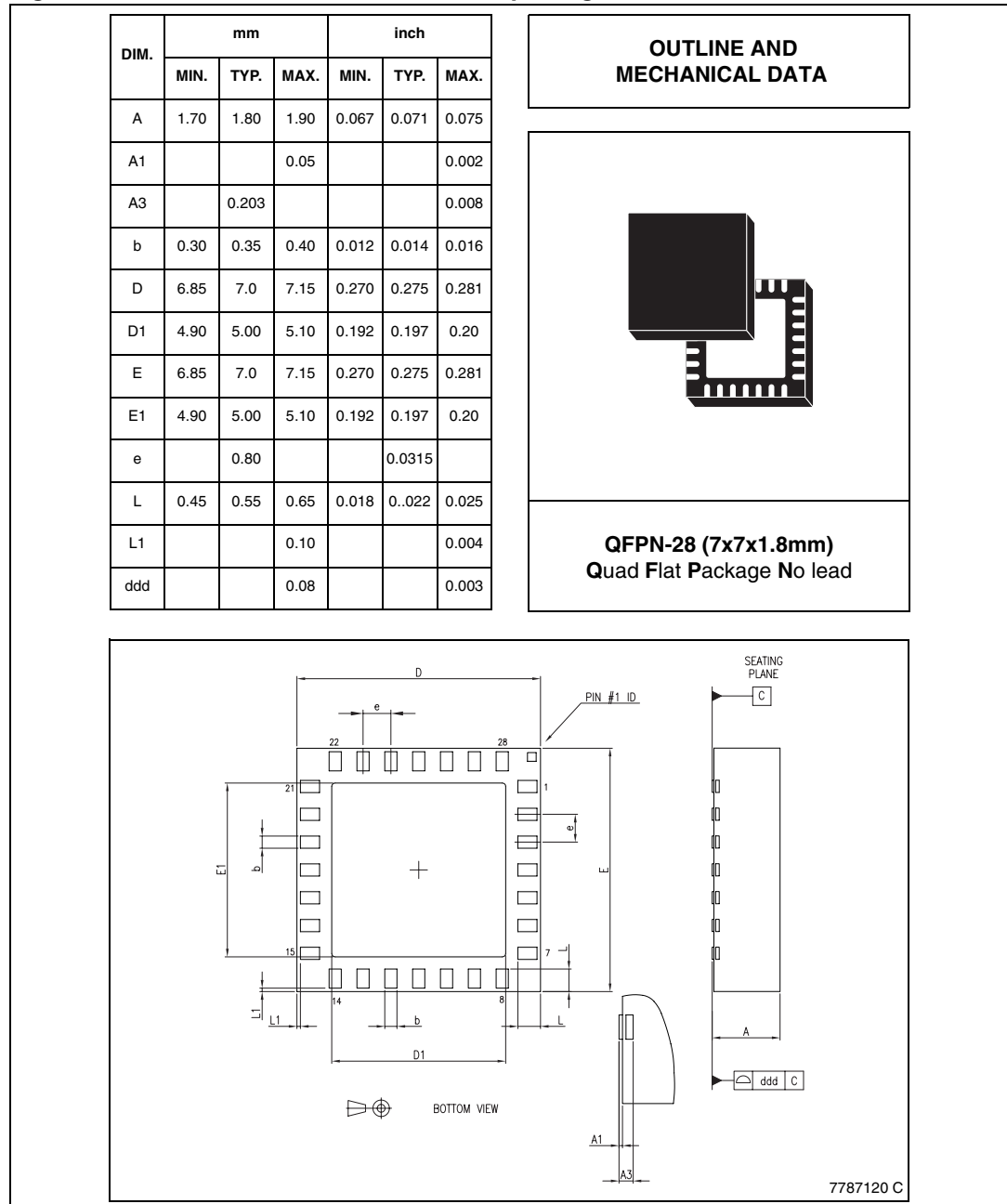

11 Revision history

Table 65. Document revision history

Date	Revision	Changes
20-Aug-2008	1	Initial release.
04-Dec-2008	2	Updated V_{ST} in Table 3 and IddPdn in Table 4 .
30-Apr-2010	3	Updated Section 4: Application hints .
01-Jun-2010	4	Content reworked on cover page to improve readability, no technical changes.

Please Read Carefully:

Information in this document is provided solely in connection with ST products. STMicroelectronics NV and its subsidiaries ("ST") reserve the right to make changes, corrections, modifications or improvements, to this document, and the products and services described herein at any time, without notice.

All ST products are sold pursuant to ST's terms and conditions of sale.

Purchasers are solely responsible for the choice, selection and use of the ST products and services described herein, and ST assumes no liability whatsoever relating to the choice, selection or use of the ST products and services described herein.

No license, express or implied, by estoppel or otherwise, to any intellectual property rights is granted under this document. If any part of this document refers to any third party products or services it shall not be deemed a license grant by ST for the use of such third party products or services, or any intellectual property contained therein or considered as a warranty covering the use in any manner whatsoever of such third party products or services or any intellectual property contained therein.

UNLESS OTHERWISE SET FORTH IN ST'S TERMS AND CONDITIONS OF SALE ST DISCLAIMS ANY EXPRESS OR IMPLIED WARRANTY WITH RESPECT TO THE USE AND/OR SALE OF ST PRODUCTS INCLUDING WITHOUT LIMITATION IMPLIED WARRANTIES OF MERCHANTABILITY, FITNESS FOR A PARTICULAR PURPOSE (AND THEIR EQUIVALENTS UNDER THE LAWS OF ANY JURISDICTION), OR INFRINGEMENT OF ANY PATENT, COPYRIGHT OR OTHER INTELLECTUAL PROPERTY RIGHT.

UNLESS EXPRESSLY APPROVED IN WRITING BY AN AUTHORIZED ST REPRESENTATIVE, ST PRODUCTS ARE NOT RECOMMENDED, AUTHORIZED OR WARRANTED FOR USE IN MILITARY, AIR CRAFT, SPACE, LIFE SAVING, OR LIFE SUSTAINING APPLICATIONS, NOR IN PRODUCTS OR SYSTEMS WHERE FAILURE OR MALFUNCTION MAY RESULT IN PERSONAL INJURY, DEATH, OR SEVERE PROPERTY OR ENVIRONMENTAL DAMAGE. ST PRODUCTS WHICH ARE NOT SPECIFIED AS "AUTOMOTIVE GRADE" MAY ONLY BE USED IN AUTOMOTIVE APPLICATIONS AT USER'S OWN RISK.

Resale of ST products with provisions different from the statements and/or technical features set forth in this document shall immediately void any warranty granted by ST for the ST product or service described herein and shall not create or extend in any manner whatsoever, any liability of ST.

ST and the ST logo are trademarks or registered trademarks of ST in various countries.

Information in this document supersedes and replaces all information previously supplied.

The ST logo is a registered trademark of STMicroelectronics. All other names are the property of their respective owners.

© 2010 STMicroelectronics - All rights reserved

STMicroelectronics group of companies

Australia - Belgium - Brazil - Canada - China - Czech Republic - Finland - France - Germany - Hong Kong - India - Israel - Italy - Japan - Malaysia - Malta - Morocco - Philippines - Singapore - Spain - Sweden - Switzerland - United Kingdom - United States of America

www.st.com