

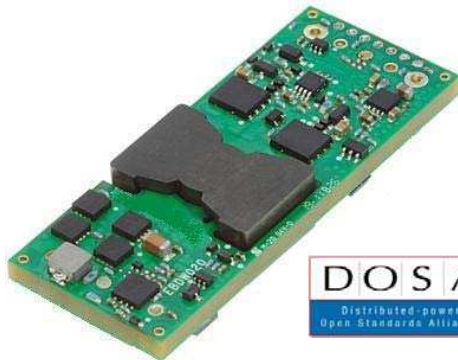

BARRACUDA SERIES™ Features



RoHS Compliant

- Compliant to RoHS EU Directive 2002/95/EC (-Z versions)
- Compatible with reflow pin/paste soldering process
- High and flat efficiency profile – 95.4% at 12V_{dc}, 55% load to 90% output
- Wide Input voltage range: 36-75V_{dc}
- Delivers up to 20A_{dc} output current
- Output Voltage adjust: 6.0V_{dc} to 13.2V_{dc}
- Tightly regulated output voltage
- Low output ripple and noise
- No reverse current during prebias start-up or shut-down
- Industry standard, DOSA compliant, Eight brick: 58.4 mm x 22.8 mm x 11.3 mm (2.30 in x 0.90 in x 0.44 in)
- Constant switching frequency
- Positive Remote On/Off logic
- Output over current/voltage protection
- Over temperature protection
- Wide operating temperature range (-40°C to 85°C)
- UL* 60950-1, 2nd Ed. Recognized, CSA† C22.2 No. 60950-1-07 Certified, and VDE‡ (EN60950-1, 2nd Ed.) Licensed
- CE mark 2006/96/EC directives§
- Meets the voltage and current requirements for ETSI 300-132-2 and complies with and licensed for Basic insulation rating per EN60950-1
- 2250 Vdc Isolation tested in compliance with IEEE 802.3¶ PoE standards
- ISO** 9001 and ISO14001 certified manufacturing facilities

Applications

- Distributed power architectures
- Intermediate bus voltage applications
- Servers and storage applications
- Networking equipment including Power over Ethernet (PoE)
- Fan assemblies other systems requiring a tightly regulated output voltage

Options

- Negative Remote On/Off logic (1=option code, factory preferred)
- Auto-restart after fault shutdown (4=option code, factory preferred)
- Remote Sense and Output Voltage Trim (9=option code)
- Base plate option (-H=option code)
- Passive Droop Load Sharing (-P=option code)

Description

The EBVW020A0B series of dc-dc converters are a new generation of DC/DC power modules designed to support 9.6 -12V_{dc} intermediate bus applications where multiple low voltages are subsequently generated using point of load (POL) converters, as well as other application requiring a tightly regulated output voltage. The EBVW020A0B series operate from an input voltage range of 36 to 75V_{dc}, and provide up to 20A output current at output voltages from 6.0V_{dc} to 12.0V_{dc}, and 240W output power from output voltages of 12.1V_{dc} to 13.2V_{dc} in a DOSA standard eighth brick. The converter incorporates digital control, synchronous rectification technology, and innovative packaging techniques to achieve efficiency reaching 95.4% peak at 12V_{dc} output. This leads to lower power dissipations such that for many applications a heat sink is not required. Standard features include on/off control, output overcurrent and over voltage protection, over temperature protection, input under and over voltage lockout. Optional features include output voltage remote sense and trim from 6.0V_{dc} to 13.2V_{dc}, passive droop paralleling, and base plate for heat sink or cold wall applications.

The output is fully isolated from the input, allowing versatile polarity configurations and grounding connections. Built-in filtering for both input and output minimizes the need for external filtering.

* UL is a registered trademark of Underwriters Laboratories, Inc.

† CSA is a registered trademark of Canadian Standards Association.

‡ VDE is a trademark of Verband Deutscher Elektrotechniker e.V.

§ This product is intended for integration into end-user equipment. All of the required procedures of end-use equipment should be followed.

¶ IEEE and 802 are registered trademarks of the Institute of Electrical and Electronics Engineers, Incorporated.

** ISO is a registered trademark of the International Organization of Standards.

Absolute Maximum Ratings

Stresses in excess of the absolute maximum ratings can cause permanent damage to the device. These are absolute stress ratings only, functional operation of the device is not implied at these or any other conditions in excess of those given in the operations sections of the Data Sheet. Exposure to absolute maximum ratings for extended periods can adversely affect device reliability.

Parameter	Device	Symbol	Min	Max	Unit
Input Voltage*					
Continuous		V _{IN}	-0.3	75	V _{dc}
Operating transient ≤ 100mS				100	V _{dc}
Operating Input transient slew rate, 50V _{IN} to 75V _{IN} (Output may exceed regulation limits, no protective shutdowns shall activate, C _O =220μF to C _{O,max})		-	-	10	V/μs
Non- operating continuous		V _{IN}	80	100	V _{dc}
Operating Ambient Temperature (See Thermal Considerations section)	All	T _A	-40	85	°C
Storage Temperature	All	T _{stg}	-55	125	°C
I/O Isolation Voltage (100% factory Hi-Pot tested)	All	—	—	2250	V _{dc}

* Input over voltage protection will shutdown the output voltage, when the input voltage exceeds threshold level.

Electrical Specifications

Unless otherwise indicated, specifications apply over all operating input voltage, resistive load, and temperature conditions.

Parameter	Device	Symbol	Min	Typ	Max	Unit
Operating Input Voltage		V _{IN}	36	48	75	V _{dc}
Maximum Input Current (V _{IN} =0V to 75V, I _O =I _{O,max})		I _{IN,max}	-	-	7	A _{dc}
Input No Load Current (V _{IN} = V _{IN,nom} , I _O = 0, module enabled)	All	I _{IN,No load}		50		mA
Input Stand-by Current (V _{IN} = V _{IN,nom} , module disabled)	All	I _{IN,stand-by}			25	mA
External Input Capacitance	All		100	-	-	μF
Inrush Transient	All	I ² t	-	-	1	A ² s
Input Reflected Ripple Current, peak-to-peak (5Hz to 20MHz, 12μH source impedance; V _{IN} = 48V, I _O = I _{O,max} ; see Figure 12)	All		-	24	-	mA _{p-p}
Input Ripple Rejection (120Hz)	All		-	50	-	dB

CAUTION: This power module is not internally fused. An input line fuse must always be used.

This power module can be used in a wide variety of applications, ranging from simple standalone operation to an integrated part of sophisticated power architecture. To preserve maximum flexibility, internal fusing is not included, however, to achieve maximum safety and system protection, always use an input line fuse. The safety agencies require a fast-acting fuse with a maximum rating of 15 A (see Safety Considerations section). Based on the information provided in this Data Sheet on inrush energy and maximum dc input current, the same type of fuse with a lower rating can be used. Refer to the fuse manufacturer's Data Sheet for further information.

Electrical Specifications (continued)

Parameter	Device	Symbol	Min	Typ	Max	Unit	
Output Voltage Set-point (V _{IN} =V _{IN,nom} , I _O =10A, T _A =25°C)	All	V _{O,set}	11.97	12.00	12.03	V _{dc}	
Output Voltage (Over all operating input voltage(40V to 75V), resistive load, and temperature conditions until end of life)	All w/o -P	V _O	11.76	—	12.24	V _{dc}	
	-P Option	V _O	11.63	—	12.37	V _{dc}	
Output Voltage (V _{IN} =36V, T _A = 25°C)	All	V _O	10.8	—	—	V _{dc}	
Output Regulation (V _{IN,min} =40V) Line (V _{IN} =V _{IN,min} to V _{IN,max}) Load (I _O =I _{O,min} to I _{O,max}) Line (V _{IN} =V _{IN,min} to V _{IN,max}) Load (I _O =I _{O,min} to I _{O,max}), Intentional Droop Temperature (T _A = -40°C to +85°C)	All w/o -P		—	0.2	—	% V _{O,set}	
	All w/o -P		—	0.2	—	% V _{O,set}	
	-P Option		—	0.5	—	% V _{O,set}	
	-P Option				0.50		V _{dc}
	All			—	2	—	% V _{O,set}
Output Ripple and Noise on nominal output (V _{IN} =V _{IN,nom} and I _O =I _{O,min} to I _{O,max} , tested with a 1.0 μF ceramic, 10 μF aluminum and 220μF polymer capacitor across the load.) RMS (5Hz to 20MHz bandwidth) Peak-to-Peak (5Hz to 20MHz bandwidth)	All		—	70	—	mV _{rms}	
	All		—	200	—	mV _{pk-pk}	
External Output Capacitance	All	C _O	220	—	10,000	μF	
Output Current	All	I _O	0		20	A _{dc}	
Output Current Limit Inception	All	I _{O,lim}	—	23	—	A _{dc}	
Efficiency (V _{IN} =V _{IN,nom} , V _O = V _{O,set} , T _A =25°C) I _O = 100% I _{O,max} I _O = 55% - 90% I _{O,max}	All	η		95.2		%	
	All	η		95.4		%	
Switching Frequency (primary MOSFETs) (Output Ripple 2X switching frequency)		f _{sw}		150		kHz	
Dynamic Load Response (dI _O /dt=1A/10μs; V _{in} =V _{in,nom} ; T _A =25°C; tested with a 10 μF ceramic and 1x 470μF polymer capacitor across the load.) Load Change from I _O = 50% to 75% of I _{O,max} : Peak Deviation Settling Time (V _O <10% peak deviation) Load Change from I _O = 75% to 50% of I _{O,max} : Peak Deviation Settling Time (V _O <10% peak deviation)	All	V _{pk} t _s	—	750	—	mV _{pk}	
			—	800	—	μs	
		V _{pk} t _s	—	750	—	mV _{pk}	
			—	800	—	μs	

Isolation Specifications

Parameter	Symbol	Min	Typ	Max	Unit
Isolation Capacitance	C _{iso}	—	1000	—	pF
Isolation Resistance	R _{iso}	10	—	—	MΩ

General Specifications

Parameter	Device	Symbol	Typ	Unit
Calculated Reliability Based upon Telcordia SR-332 Issue 2: Method I, Case 1, (I _O =80%I _{O,max} , T _A =40°C, Airflow = 200 lfm), 90% confidence	All	MTBF	4,169,213	Hours
	All	FIT	239.9	10 ⁹ /Hours
Weight – Open Frame			29.5 (1.04)	g (oz.)
Weight – with Baseplate option			39.0 (1.38)	g (oz.)

Feature Specifications

Unless otherwise indicated, specifications apply over all operating input voltage, resistive load, and temperature conditions. See Feature Descriptions for additional information.

Parameter	Device	Symbol	Min	Typ	Max	Unit
Remote On/Off Signal Interface (V _{IN} =V _{IN,min} to V _{IN,max} , Signal referenced to V _{IN} -terminal) Negative Logic: device code suffix "1" Logic Low = module On, Logic High = module Off Positive Logic: No device code suffix required Logic Low = module Off, Logic High = module On Logic Low Specification On/Off Thresholds:						
Remote On/Off Current – Logic Low	All	I _{on/off}	280	—	310	μA
Logic Low Voltage	All	V _{on/off}	-0.3	—	0.8	V _{dc}
Logic High Voltage – (Typ = Open Collector)	All	V _{on/off}	2.0	—	14.5	V _{dc}
Logic High maximum allowable leakage current (V _{on/off} = 2.0V)	All	I _{on/off}	—	—	10	μA
Maximum voltage allowed on On/Off pin	All	V _{on/off}	—	—	14.5	V _{dc}
Turn-on Delay and Rise Time (I _O =I _{O,max}) T _{delay} =Time until V _O = 10% of V _{O,set} from either application of Vin with Remote On/Off set to On (Enable with Vin); or operation of Remote On/Off from Off to On with Vin already applied for at least 150 milli-seconds (Enable with on/off). * Increased T _{delay} due to startup for parallel modules.	All w/o -P All w/o-P w/ -P w/ -P	T _{delay, Enable with Vin} T _{delay, Enable with on/off} T _{delay, Enable with Vin} T _{delay, Enable with on/off}	— — — —	— — — —	160 40 180* 40*	ms ms ms ms
T _{rise} =Time for V _O to rise from 10% to 90% of V _{O,set} . For C _O >5000uF, I _O must be < 50% I _{O,max} during T _{rise} . * Increased T _{rise} when Vo exists at startup for parallel modules.	All w/o -P w/ -P	T _{rise} T _{rise}	— —	— —	40 300*	ms ms
Load Sharing Current Balance (difference in output current across all modules with outputs in parallel, no load to full load)	-P Option	I _{diff}			3	A
Prebias Output Load Performance: Back Bias current sunk by output during start-up Back Bias current sunk by output during shut-down	All		— —	— —	50 50	mA mA
Remote Sense Range	All w/ "9" option	V _{Sense}	—	—	0.5	V _{dc}
Output Voltage Adjustment range	All w/ "9" option	V _{O,set}	6.0		13.2	V _{dc}
Output Overvoltage Protection	All	V _{O,limit}	14.5		17.0	V _{dc}
Overtemperature Protection (See Feature Descriptions)	All	T _{ref}	—	140	—	°C
Input Undervoltage Lockout Turn-on Threshold Turn-off Threshold			— 32	35 33.5	36 —	V _{dc} V _{dc}
Input Overvoltage Lockout Turn-off Threshold Turn-on Threshold			— 76	85 79	86 —	V _{dc} V _{dc}

Characteristic Curves

The following figures provide typical characteristics for the EBVW020A0B (12V, 20A) at 25°C. The figures are identical for either positive or negative Remote On/Off logic.

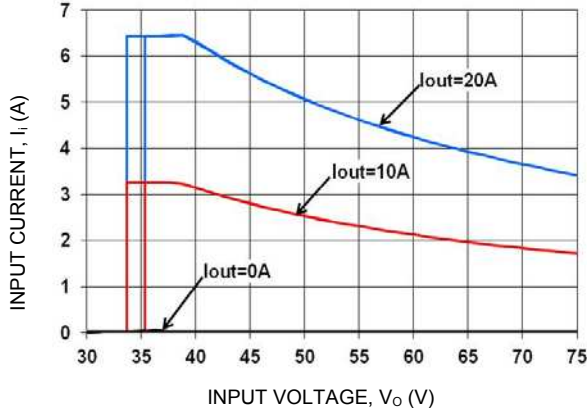

Figure 1. Typical Input Characteristic at Room Temperature.

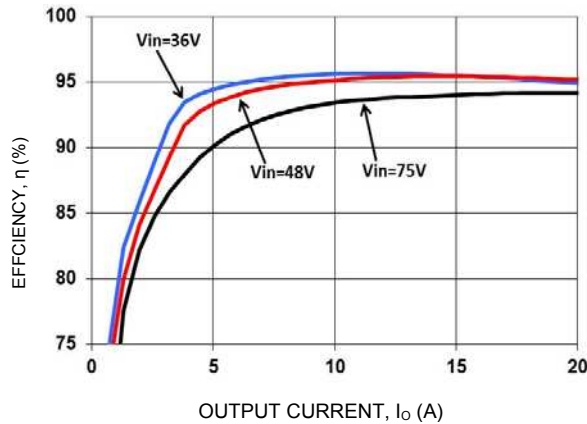

Figure 2. Typical Converter Efficiency Vs. Output current at Room Temperature.

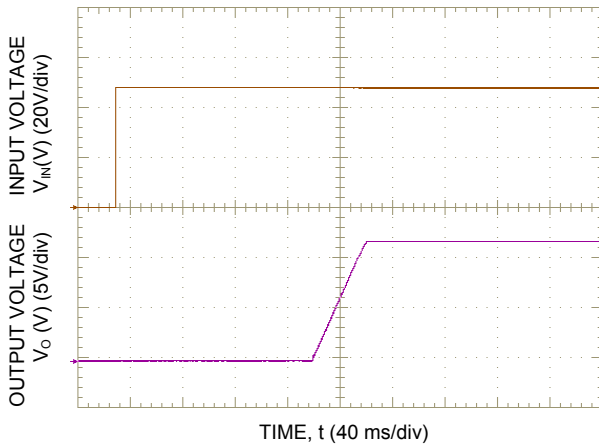

Figure 3. Typical Start-Up Using Vin with Remote On/Off enabled, negative logic version shown.

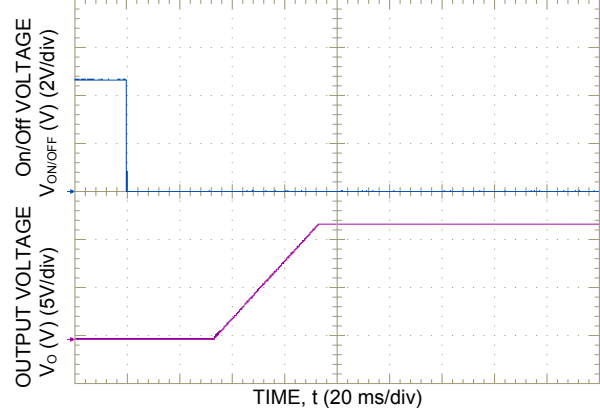

Figure 4. Typical Start-Up Using Remote On/Off with Vin applied, negative logic version shown.

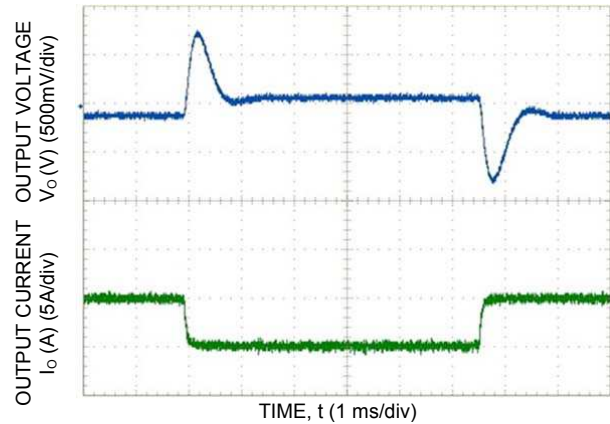

Figure 5. Typical Transient Response to Step change in Load from 25% to 50% to 25% of Full Load at 48 Vdc Input and 470uF Polymer.

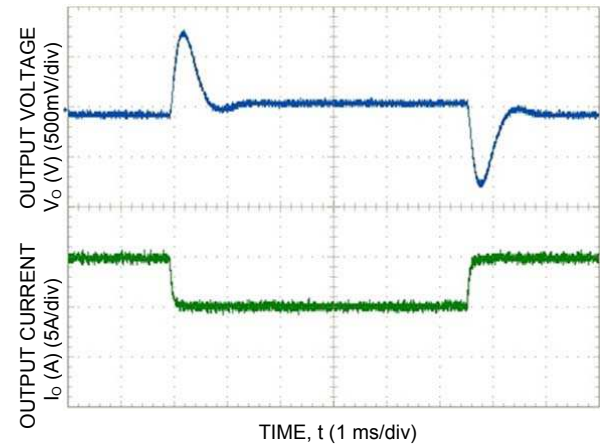

Figure 6. Typical Transient Response to Step Change in Load from 50% to 75% to 50% of Full Load at 48 Vdc Input and 470uF Polymer.

Characteristic Curves (continued)

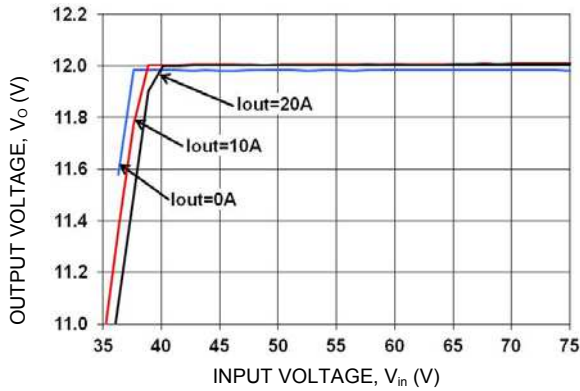

Figure 7. Typical Output Voltage Regulation vs. Input Voltage at Room Temperature.

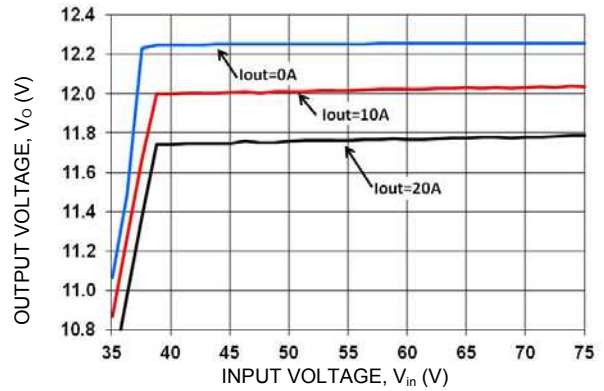

Figure 10. Typical Output Voltage Regulation vs. Input Voltage for the -P Version at Room Temperature.

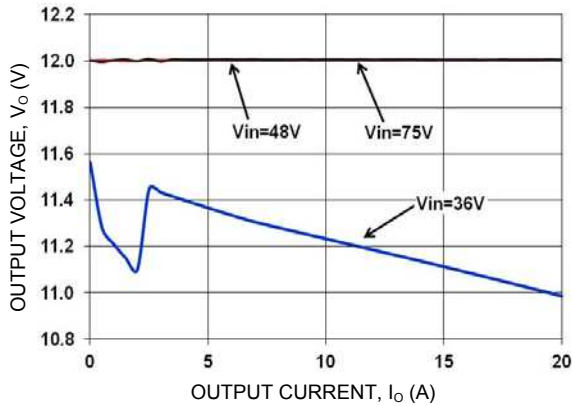

Figure 8. Typical Output Voltage Regulation vs. Output Current at Room Temperature.

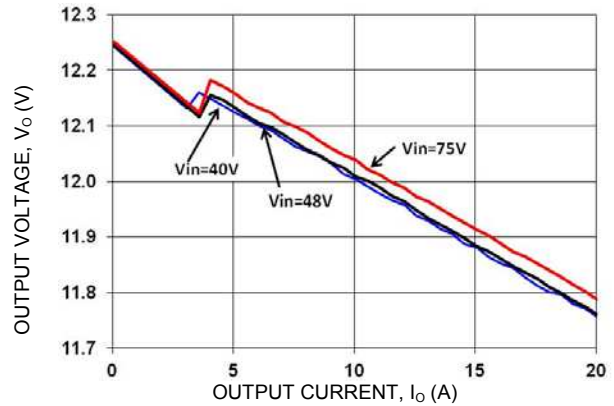

Figure 11. Typical Output Voltage Regulation vs. Output Current for the -P Version at Room Temperature.

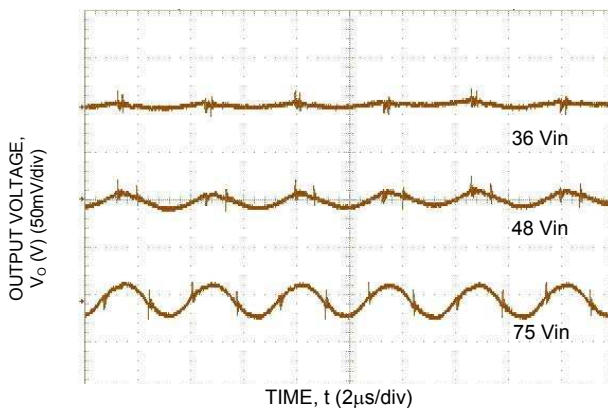
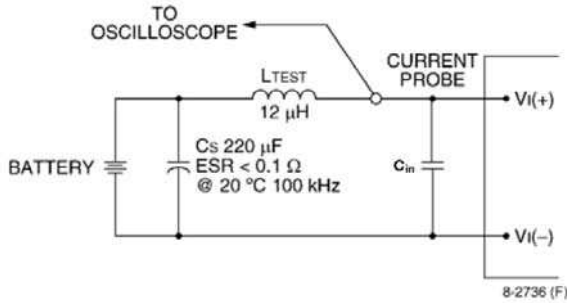

Figure 9. Typical Output Ripple and Noise at Room Temperature $I_o = I_{o,max}$ and C_{OMin} .

Test Configurations



Note: Measure input reflected-ripple current with a simulated source inductance (LTEST) of 12 µH. Capacitor CS offsets possible battery impedance. Measure current as shown above.

Figure 12. Input Reflected Ripple Current Test Setup.

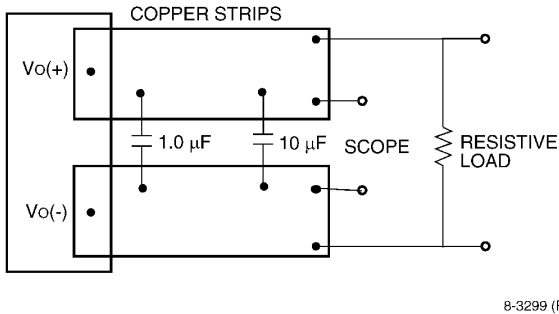

Note: Use a 1.0 µF ceramic capacitor and a 10 µF aluminum or tantalum capacitor. Scope measurement should be made using a BNC socket. Position the load between 51 mm and 76 mm (2 in. and 3 in.) from the module.

Figure 13. Output Ripple and Noise Test Setup.

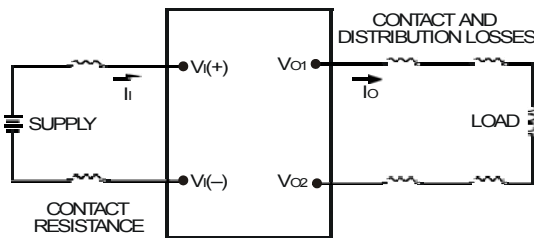

Note: All measurements are taken at the module terminals. When socketing, place Kelvin connections at module terminals to avoid measurement errors due to socket contact resistance.

$$\eta = \left(\frac{[V_{O(+)} - V_{O(-)}]I_{O}}{[V_{I(+)} - V_{I(-)}]I_{I}} \right) \times 100 \%$$

Figure 14. Output Voltage and Efficiency Test Setup.

Design Considerations

Input Source Impedance

The power module should be connected to a low ac-impedance source. A highly inductive source impedance can affect the stability of the power module. For the test configuration in Figure 12, a 220µF electrolytic capacitor, C_{in}, (ESR<0.7Ω at 100kHz), mounted close to the power module helps ensure the stability of the unit. If the module is subjected to rapid on/off cycles, a 330µF input capacitor is required. Consult the factory for further application guidelines.

Safety Considerations

For safety-agency approval of the system in which the power module is used, the power module must be installed in compliance with the spacing and separation requirements of the end-use safety agency standard, i.e., UL60950-1 2nd Ed., CSA C22.2 No. 60950-1 2nd Ed., and VDE0805-1 EN60950-1 2nd Ed.

If the input source is non-SELV (ELV or a hazardous voltage greater than 60 Vdc and less than or equal to 75Vdc), for the module's output to be considered as meeting the requirements for safety extra-low voltage (SELV), all of the following must be true:

- The input source is to be provided with reinforced insulation from any other hazardous voltages, including the ac mains.
- One V_{IN} pin and one V_{OUT} pin are to be grounded, or both the input and output pins are to be kept floating.
- The input pins of the module are not operator accessible.
- Another SELV reliability test is conducted on the whole system (combination of supply source and subject module), as required by the safety agencies, to verify that under a single fault, hazardous voltages do not appear at the module's output.

Note: Do not ground either of the input pins of the module without grounding one of the output pins. This may allow a non-SELV voltage to appear between the output pins and ground.

The power module has safety extra-low voltage (SELV) outputs when all inputs are SELV.

The input to these units is to be provided with a maximum 15 A fast-acting (or time-delay) fuse in the unearthed lead.

The power module has internally generated voltages exceeding safety extra-low voltage. Consideration should be taken to restrict operator accessibility.

Feature Descriptions

Overcurrent Protection

To provide protection in a fault output overload condition, the module is equipped with internal current-limiting circuitry and can endure current limiting continuously. If the overcurrent condition causes the output voltage to fall greater than 4.0V from V_{o,set}, the module will shut down and remain latched off. The overcurrent latch is reset by either cycling the input power or by toggling the on/off pin for one second. If the output overload condition still exists when the module restarts, it will shut down again. This operation will continue indefinitely until the overcurrent condition is corrected.

A factory configured auto-restart option (with overcurrent and overvoltage auto-restart managed as a group) is also available. An auto-restart feature continually attempts to restore the operation until fault condition is cleared.

Remote On/Off

The module contains a standard on/off control circuit reference to the V_{IN(-)} terminal. Two factory configured remote on/off logic options are available. Positive logic remote on/off turns the module on during a logic-high voltage on the ON/OFF pin, and off during a logic low. Negative logic remote on/off turns the module off during a logic high, and on during a logic low. Negative logic, device code suffix "1," is the factory-preferred configuration. The On/Off circuit is powered from an internal bias supply, derived from the input voltage terminals. To turn the power module on and off, the user must supply a switch to control the voltage between the On/Off terminal and the V_{IN(-)} terminal (V_{on/off}). The switch can be an open collector or equivalent (see Figure 15). A logic low is V_{on/off} = -0.3V to 0.8V. The typical I_{on/off} during a logic low (V_{in}=48V, On/Off Terminal=0.3V) is 147μA. The switch should maintain a logic-low voltage while sinking 310μA. During a logic high, the maximum V_{on/off} generated by the power module is 8.2V. The maximum allowable leakage current of the switch at V_{on/off} = 2.0V is 10μA. If using an external voltage source, the maximum voltage V_{on/off} on the pin is 14.5V with respect to the V_{IN(-)} terminal.

If not using the remote on/off feature, perform one of the following to turn the unit on:

For negative logic, short ON/OFF pin to V_{IN(-)}.

For positive logic: leave ON/OFF pin open.

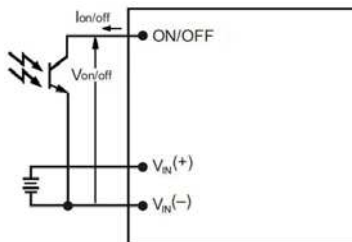

Figure 15. Remote On/Off Implementation.

Output Overvoltage Protection

The module contains circuitry to detect and respond to output overvoltage conditions. If the overvoltage condition

causes the output voltage to rise above the limit in the Specifications Table, the module will shut down and remain latched off. The overvoltage latch is reset by either cycling the input power, or by toggling the on/off pin for one second. If the output overvoltage condition still exists when the module restarts, it will shut down again. This operation will continue indefinitely until the overvoltage condition is corrected.

A factory configured auto-restart option (with overcurrent and overvoltage auto-restart managed as a group) is also available. An auto-restart feature continually attempts to restore the operation until fault condition is cleared.

Overtemperature Protection

These modules feature an overtemperature protection circuit to safeguard against thermal damage. The circuit shuts down the module when the maximum device reference temperature is exceeded. The module will automatically restart once the reference temperature cools by ~25°C.

Input Under/Over voltage Lockout

At input voltages above or below the input under/over voltage lockout limits, module operation is disabled. The module will begin to operate when the input voltage level changes to within the under and overvoltage lockout limits.

Load Sharing

For higher power requirements, the EBVW020A0 power module offers an optional feature for parallel operation (-P Option code). This feature provides a precise forced output voltage load regulation droop characteristic. The output set point and droop slope are factory calibrated to insure optimum matching of multiple modules' load regulation characteristics. To implement load sharing, the following requirements should be followed:

- The V_{OUT(+)} and V_{OUT(-)} pins of all parallel modules must be connected together. Balance the trace resistance for each module's path to the output power planes, to insure best load sharing and operating temperature balance.
- V_{IN} must remain between 40V_{dc} and 75V_{dc} for droop sharing to be functional.
- It is permissible to use a common Remote On/Off signal to start all modules in parallel.
- These modules contain means to block reverse current flow upon start-up, when output voltage is present from other parallel modules, thus eliminating the requirement for external output ORing devices. Modules with the -P option will self determine the presence of voltage on the output from other operating modules, and automatically increase its Turn On delay, T_{delay}, as specified in the Feature Specifications Table.
- When parallel modules startup into a pre-biased output, e.g. partially discharged output capacitance, the T_{rise} is automatically increased, as specified in the Feature Specifications Table, to insure graceful startup.
- Insure that the load is <50% I_{O,MAX} (for a single module) until all parallel modules have started (load full start > module T_{delay} time max + T_{rise} time).
- If fault tolerance is desired in parallel applications, output ORing devices should be used to prevent a single module failure from collapsing the load bus.

Feature Descriptions (continued)

Remote Sense (“9” Option Code)

Remote sense minimizes the effects of distribution losses by regulating the voltage at the remote-sense connections (See Figure 16). The voltage between the remote-sense pins and the output terminals must not exceed the output voltage sense range given in the Feature Specifications table:

$$[V_{O(+)} - V_{O(-)}] - [\text{SENSE}(+) - \text{SENSE}(-)] \leq 0.5 \text{ V}$$

Although the output voltage can be increased by both the remote sense and by the trim, the maximum increase for the output voltage is not the sum of both. The maximum increase is the larger of either the remote sense or the trim.

The amount of power delivered by the module is defined as the voltage at the output terminals multiplied by the output current. When using remote sense and trim, the output voltage of the module can be increased, which at the same output current would increase the power output of the module. Care should be taken to ensure that the maximum output power of the module remains at or below the maximum rated power (Maximum rated power = $V_{O,set} \times I_{O,max}$).

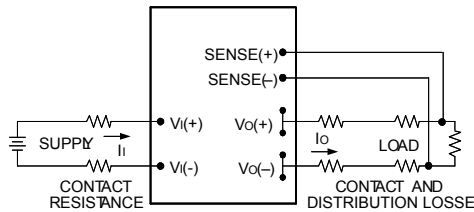

Figure 16. Circuit Configuration for remote sense.

Trim, Output Voltage Programming

Trimming allows the output voltage set point to be increased or decreased; this is accomplished by connecting an external resistor between the TRIM pin and either the $V_{O}(+)$ pin or the $V_{O}(-)$ pin.

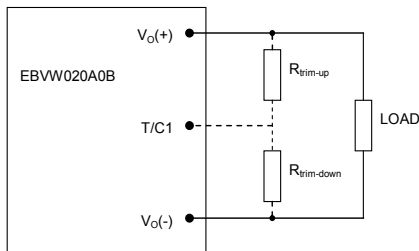

Figure 17. Circuit Configuration to Trim Output Voltage.

Connecting an external resistor ($R_{trim-down}$) between the T/C1 pin and the $V_{O}(-)$ (or Sense(-)) pin decreases the output voltage set point. To maintain set point accuracy, the trim resistor tolerance should be $\pm 1.0\%$.

The following equation determines the required external resistor value to obtain a percentage output voltage change of $\Delta\%$

$$R_{trim-down} = \left[\frac{511}{\Delta\%} - 10.22 \right] \text{K}\Omega$$

$$\text{Where } \Delta\% = \left(\frac{V_{o,set} - V_{desired}}{V_{o,set}} \right) \times 100$$

For example, to trim-down the output voltage of the module by 20% to 9.6V, $R_{trim-down}$ is calculated as follows:

$$\Delta\% = 20$$

$$R_{trim-down} = \left[\frac{511}{20} - 10.22 \right] \text{k}\Omega = 15.3 \text{k}\Omega$$

Connecting an external resistor ($R_{trim-up}$) between the T/C1 pin and the $V_{O}(+)$ (or Sense (+)) pin increases the output voltage set point. The following equations determine the required external resistor value to obtain a percentage output voltage change of $\Delta\%$:

$$R_{trim-up} = \left[\frac{5.11 \times V_{o,set} \times (100 + \Delta\%)}{1.225 \times \Delta\%} - \frac{511}{\Delta\%} - 10.22 \right] \text{K}\Omega$$

$$\text{Where } \Delta\% = \left(\frac{V_{desired} - V_{o,set}}{V_{o,set}} \right) \times 100$$

For example, to trim-up the output voltage of the module by 5% to 12.6V, $R_{trim-up}$ is calculated is as follows:

$$\Delta\% = 5$$

$$R_{trim-up} = \left[\frac{5.11 \times 12.0 \times (100 + 5)}{1.225 \times 5} - \frac{511}{5} - 10.22 \right] \text{k}\Omega = 938.8 \text{k}\Omega$$

The voltage between the $V_{O}(+)$ and $V_{O}(-)$ terminals must not exceed the minimum output overvoltage protection value shown in the Feature Specifications table. This limit includes any increase in voltage due to remote-sense compensation and output voltage set-point adjustment trim.

Although the output voltage can be increased by both the remote sense and by the trim, the maximum increase for the output voltage is not the sum of both. The maximum increase is the larger of either the remote sense or the trim. The amount of power delivered by the module is defined as the voltage at the output terminals multiplied by the output current. When using remote sense and trim, the output voltage of the module can be increased, which at the same output current would increase the power output of the module. Care should be taken to ensure that the maximum output power of the module remains at or below the maximum rated power (Maximum rated power = $V_{O,set} \times I_{O,max}$).

Thermal Considerations

The power modules operate in a variety of thermal environments and sufficient cooling should be provided to help ensure reliable operation.

Thermal considerations include ambient temperature, airflow, module power dissipation, and the need for increased reliability. A reduction in the operating temperature of the module will result in an increase in reliability. The thermal data presented here is based on physical measurements taken in a wind tunnel.

Feature Descriptions (continued)

Heat-dissipating components are mounted on the top side of the module. Heat is removed by conduction, convection and radiation to the surrounding environment. Proper cooling can be verified by measuring the thermal reference temperature (TH_x). Peak temperature (TH_x) occurs at the position indicated in Figure 18 and 19. For reliable operation this temperature should not exceed the listed temperature threshold.

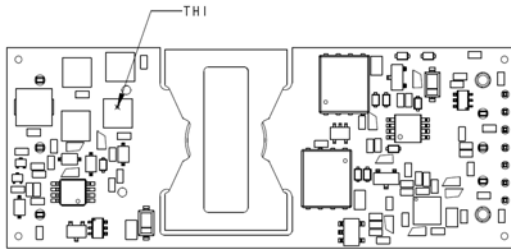

Figure 18. Location of the thermal reference temperature TH₁. Do not exceed 113 °C.

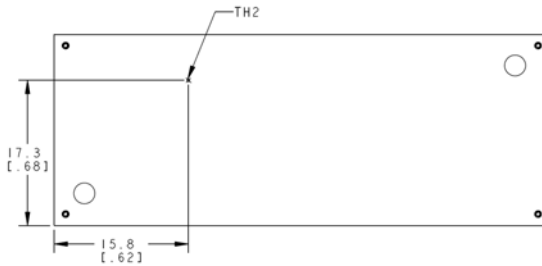

Figure 19. Location of the thermal reference temperature TH₂ for Base Plate module. Do not exceed 110 °C.

The output power of the module should not exceed the rated power for the module as listed in the Ordering Information table.

Although the maximum temperature of the power modules is TH_x, you can limit this temperature to a lower value for extremely high reliability.

Please refer to the Application Note “Thermal Characterization Process For Open-Frame Board-Mounted Power Modules” for a detailed discussion of thermal aspects including maximum device temperatures.

Heat Transfer via Convection

Increased airflow over the module enhances the heat transfer via convection. The thermal derating of figures 20 through 22 show the maximum output current that can be delivered by each module in the indicated orientation without exceeding the maximum TH_x temperature versus local ambient temperature (T_A) for air flows of, Natural Convection, 1 m/s (200 ft./min), 2 m/s (400 ft./min).

The use of Figures 20 is shown in the following example:

Example

What is the minimum airflow necessary for a EBVW020A0B operating at V_i = 48 V, an output current of 14A, and a maximum ambient temperature of 70 °C in transverse orientation.

LINEAGE POWER

Solution:

Given: V_{in} = 48V, I_O = 14A, T_A = 70 °C

Determine required airflow (V) (Use Figure 20):

V = 200LFM or greater.

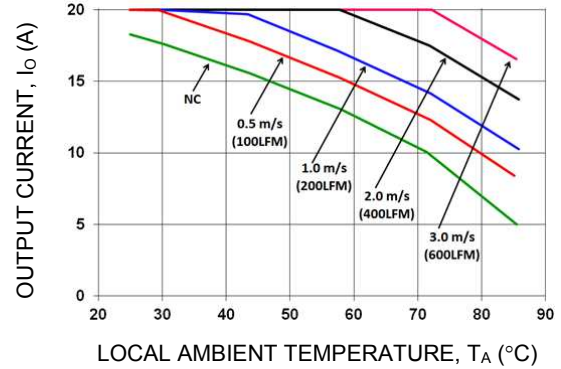

Figure 20. Output Current Derating for the Open Frame EBVW020A0B in the Transverse Orientation; Airflow Direction from Vin(-) to Vin(+); V_{in} = 48V.

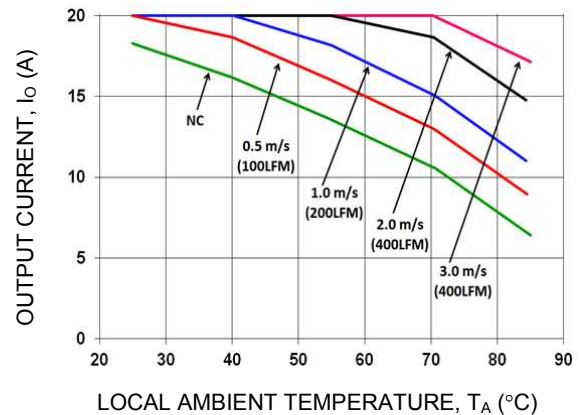

Figure 21. Output Current Derating for the Base Plate EBVW020A0Bxx-H in the Transverse Orientation; Airflow Direction from Vin(-) to Vin(+); V_{in} = 48V.

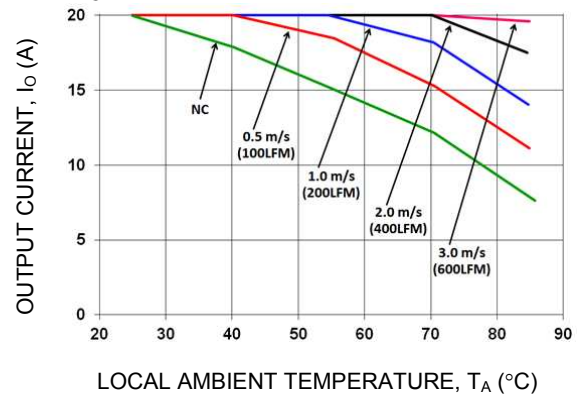

Figure 22. Output Current Derating for the Base Plate EBVW020A0Bxx-H and 0.25" heat sink in the Transverse Orientation; Airflow Direction from Vin(-) to Vin(+); V_{in} = 48V.

Layout Considerations

The EBVW020 power module series are low profile in order to be used in fine pitch system card architectures. As such, component clearance between the bottom of the power module and the mounting board is limited. Avoid placing copper areas on the outer layer directly underneath the power module. Also avoid placing via interconnects underneath the power module.

For additional layout guide-lines, refer to FLT007A0Z Data Sheet.

Through-Hole Lead-Free Soldering Information

The RoHS-compliant, Z version, through-hole products use the SAC (Sn/Ag/Cu) Pb-free solder and RoHS-compliant components. The non-Z version products use lead-tin (Pb/Sn) solder and RoHS-compliant components. Both version modules are designed to be processed through single or dual wave soldering machines. The pins have an RoHS-compliant, pure tin finish that is compatible with both Pb and Pb-free wave soldering processes. A maximum preheat rate of 3°C/s is suggested. The wave preheat process should be such that the temperature of the power module board is kept below 210°C. For Pb solder, the recommended pot temperature is 260°C, while the Pb-free solder pot is 270°C max. Not all RoHS-compliant through-hole products can be processed with paste-through-hole Pb or Pb-free reflow process. If additional information is needed, please consult with your Lineage Power representative for more details.

Reflow Lead-Free Soldering Information

The RoHS-compliant through-hole products can be processed with the following paste-through-hole Pb or Pb-free reflow process.

Max. sustain temperature :

245°C (J-STD-020C Table 4-2: Packaging Thickness $\geq 2.5\text{mm}$ / Volume $> 2000\text{mm}^3$),

Peak temperature over 245°C is not suggested due to the potential reliability risk of components under continuous high-temperature.

Min. sustain duration above 217°C : 90 seconds

Min. sustain duration above 180°C : 150 seconds

Max. heat up rate: 3°C/sec

Max. cool down rate: 4°C/sec

In compliance with JEDEC J-STD-020C spec for 2 times reflow requirement.

Pb-free Reflow Profile

BMP module will comply with J-STD-020 Rev. C (Moisture/Reflow Sensitivity Classification for Nonhermetic Solid State Surface Mount Devices) for both Pb-free solder profiles and MSL classification procedures. BMP will comply with JEDEC J-STD-020C specification for 3 times reflow requirement. The suggested Pb-free solder paste is Sn/Ag/Cu (SAC). The

recommended linear reflow profile using Sn/Ag/Cu solder is shown in Figure 23.

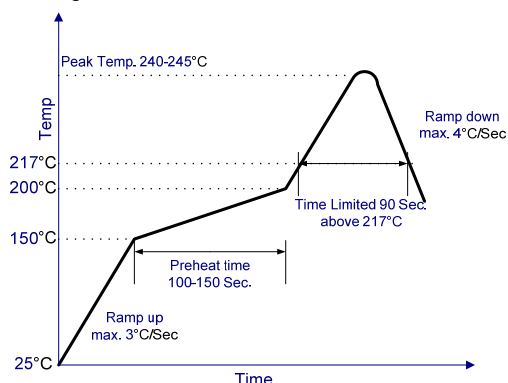

Figure 23. Recommended linear reflow profile using Sn/Ag/Cu solder.

MSL Rating

The EBVW020A0BA modules have a MSL rating of 2a.

Storage and Handling

The recommended storage environment and handling procedures for moisture-sensitive surface mount packages is detailed in J-STD-033 Rev. A (Handling, Packing, Shipping and Use of Moisture/Reflow Sensitive Surface Mount Devices). Moisture barrier bags (MBB) with desiccant are required for MSL ratings of 2 or greater. These sealed packages should not be broken until time of use. Once the original package is broken, the floor life of the product at conditions of $\leq 30^\circ\text{C}$ and 60% relative humidity varies according to the MSL rating (see J-STD-025A). The shelf life for dry packed SMT packages will be a minimum of 12 months from the bag seal date, when stored at the following conditions: $< 40^\circ\text{C}$, $< 90\%$ relative humidity.

Post Solder Cleaning and Drying Considerations

Post solder cleaning is usually the final circuit-board assembly process prior to electrical board testing. The result of inadequate cleaning and drying can affect both the reliability of a power module and the testability of the finished circuit-board assembly. For guidance on appropriate soldering, cleaning and drying procedures, refer to Lineage Power *Board Mounted Power Modules: Soldering and Cleaning Application Note* (AP01-056EPS).

EMC Considerations

The circuit and plots in Figure 24 shows a suggested configuration to meet the conducted emission limits of EN55022 Class B. For further information on designing for EMC compliance, please refer to the FLT007A0 data sheet.

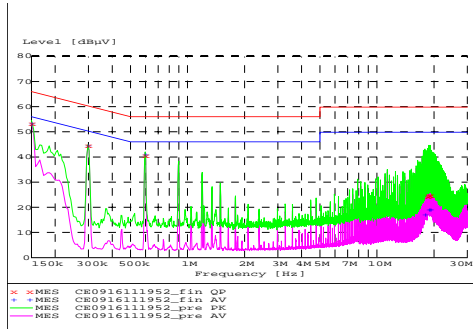
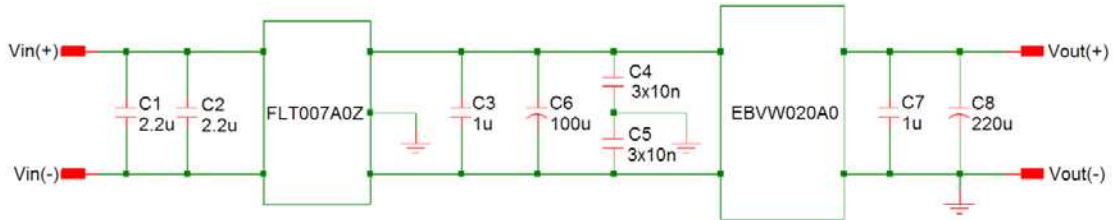

Figure 24. EMC Considerations.

Packaging Details

All versions of the EBVW020A0B are supplied as standard in the plastic trays shown in Figure 25.

Tray Specification

Material	PET (1mm)
Max surface resistivity	$10^9 - 10^{11} \Omega/\text{PET}$
Color	Clear
Capacity	18 power modules
Min order quantity	36 pcs (1 box of 2 full trays + 1 empty top tray)

Each tray contains a total of 18 power modules. The trays are self-stacking and each shipping box for the EBVW020A0B module contains 2 full trays plus one empty hold-down tray giving a total number of 36 power modules.

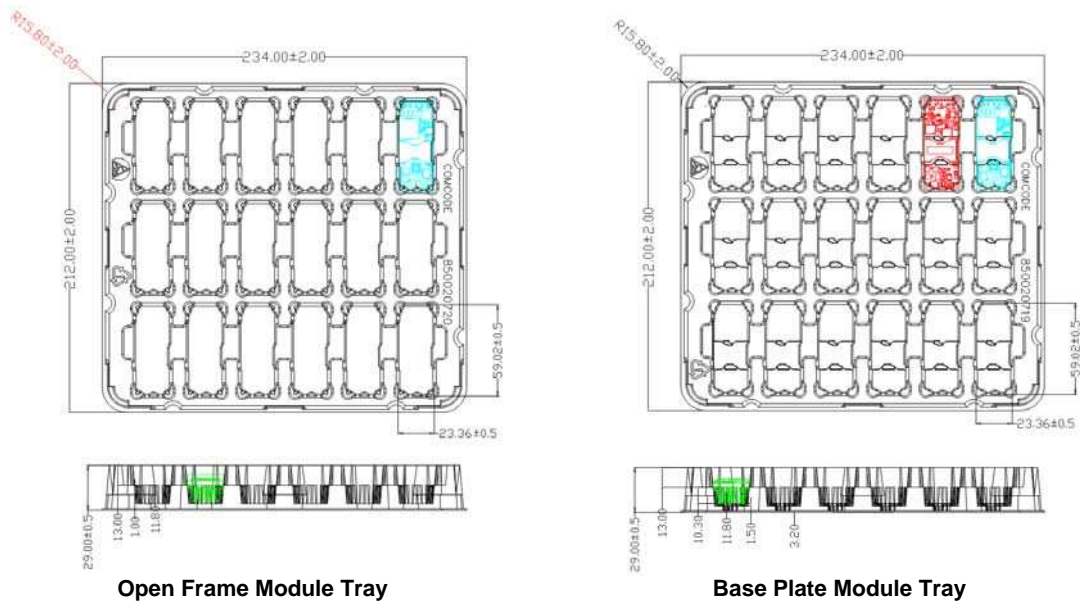

Figure 25. EBVW020 Packaging Tray

Mechanical Outline for EBVW020A0B Through-hole Module

Dimensions are in millimeters and [inches].

Tolerances: x.x mm ± 0.5 mm [x.xx in. ± 0.02 in.] (Unless otherwise indicated)
x.xx mm ± 0.25 mm [x.xxx in. ± 0.010 in.]

Top side label includes Lineage Power name, product designation and date code.

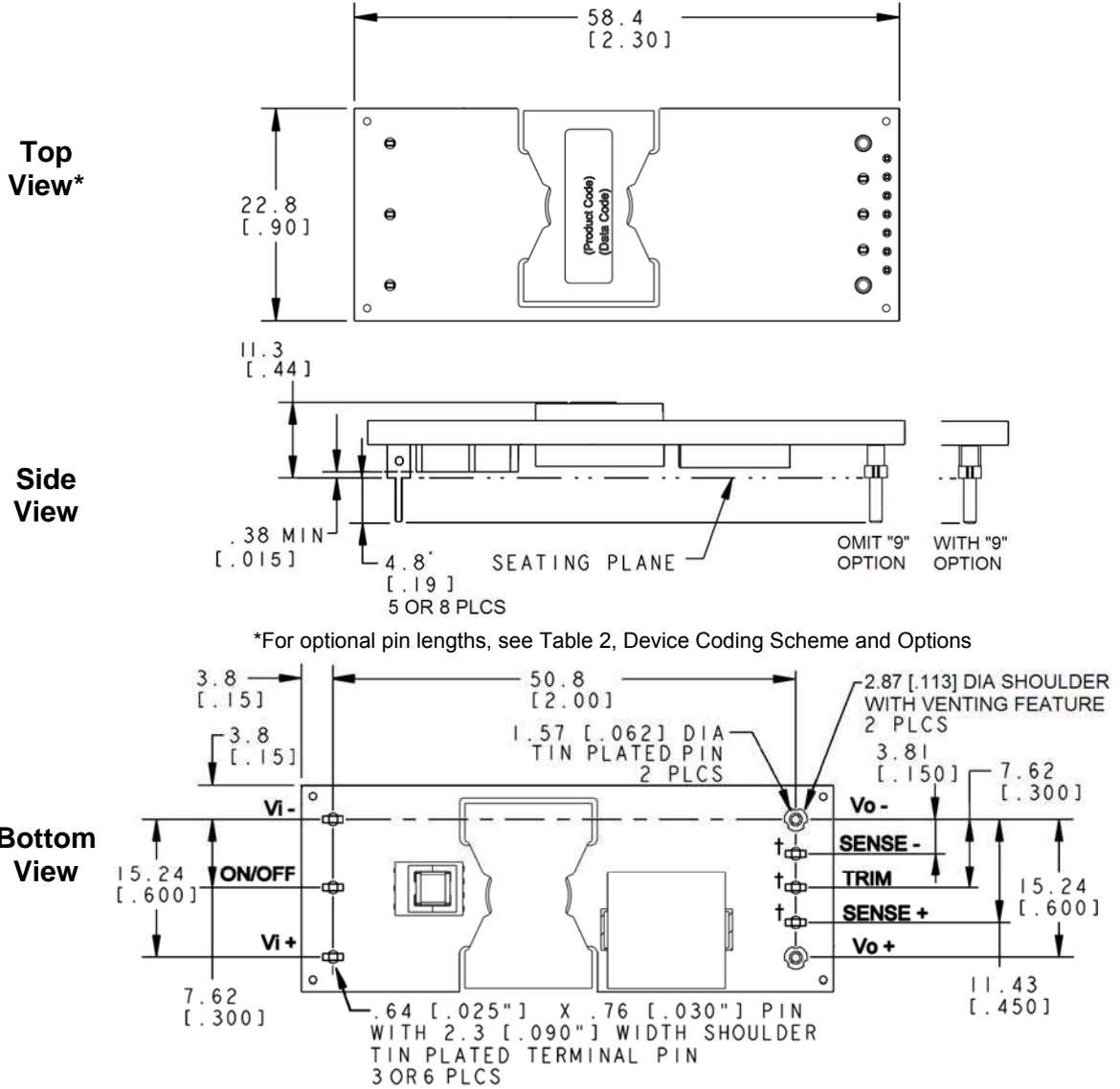

Pin	Function
1	Vi(+)
2	ON/OFF
3	Vi(-)
4	Vo(-)
5 [†]	SENSE(-)
6 [†]	TRIM
7 [†]	SENSE(+)
8	Vo(+)

† - Optional Pins, when including "9" Option, See Table 2

Mechanical Outline for EBVW020A0B-H (Baseplate version) Through-hole Module

Dimensions are in millimeters and [inches].

Tolerances: x.x mm ± 0.5 mm [x.xx in. ± 0.02 in.] (Unless otherwise indicated)

x.xx mm ± 0.25 mm [x.xxx in ± 0.010 in.]

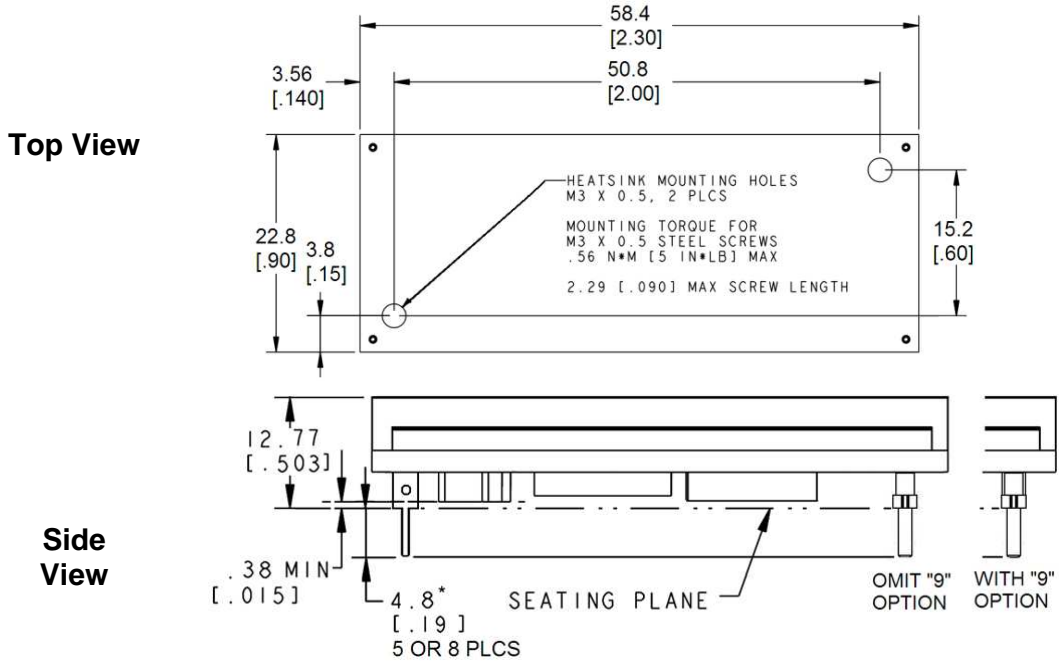

*For optional pin lengths, see Table 2, Device Coding Scheme and Options

* Bottom side label includes Lineage Power name, product designation and date

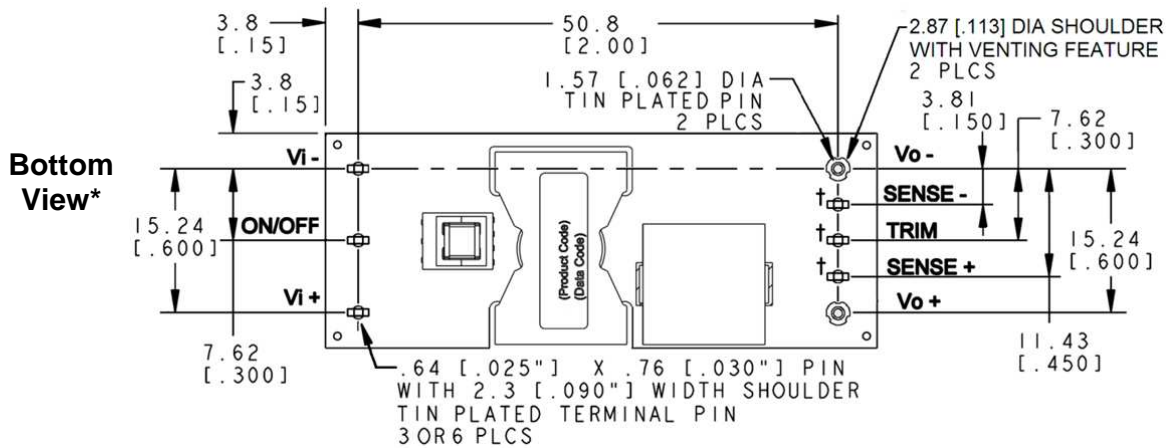

Pin	Function
1	Vi(+)
2	ON/OFF
3	Vi(-)
4	Vo(-)
5†	SENSE(-)
6†	TRIM
7†	SENSE(+)
8	Vo(+)

† - Optional Pins, when including "9" Option, See Table 2

Recommended Pad Layouts

Dimensions are in millimeters and (inches).

Tolerances: x.x mm ± 0.5 mm (x.xx in. ± 0.02 in.) [unless otherwise indicated]

x.xx mm ± 0.25 mm (x.xxx in ± 0.010 in.)

Through-Hole Modules

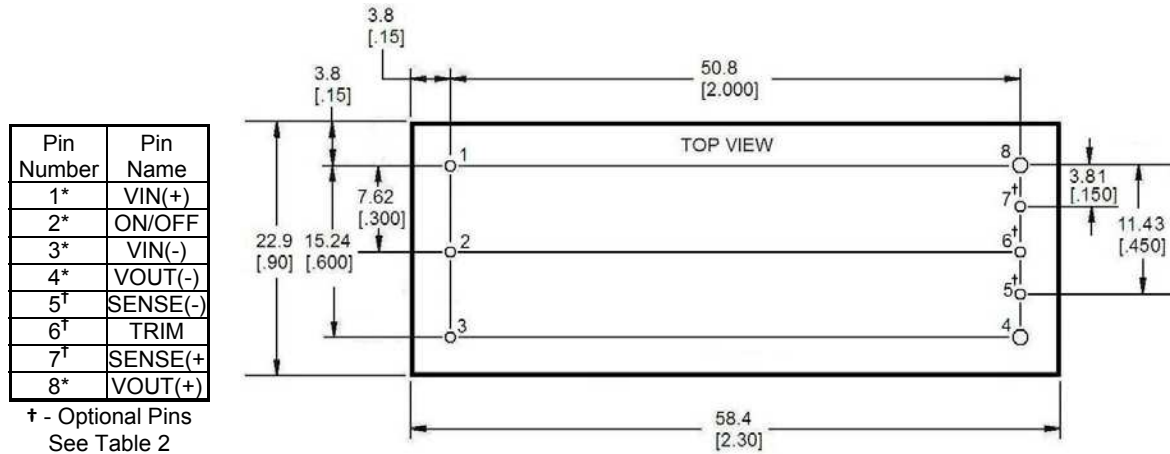

Ordering Information

Please contact your Lineage Power Sales Representative for pricing, availability and optional features.

Table 1. Device Codes

Product codes	Input Voltage	Output Voltage	Output Current	Efficiency	Connector Type	Comcodes
EBVW020A0B1Z	48V (36-75Vdc)	12V	20A	95.2%	Through hole	150019309
EBVW020A0B41Z	48V (36-75Vdc)	12V	20A	95.2%	Through hole	CC109167508
EBVW020A0B64Z	48V (36-75Vdc)	12V	20A	95.2%	Through hole	150021139
EBVW020A0B641Z	48V (36-75Vdc)	12V	20A	95.2%	Through hole	CC109172466
EBVW020A0B841Z	48V (36-75Vdc)	12V	20A	95.2%	Through hole	150022307
EBVW020A0B941Z	48V (36-75Vdc)	12V	20A	95.2%	Through hole	CC109172367
EBVW020A0B984Z	48V (36-75Vdc)	12V	20A	95.2%	Through hole	150022795
EBVW020A0B41-HZ	48V (36-75Vdc)	12V	20A	95.2%	Through hole	CC109167516
EBVW020A0B64-HZ	48V (36-75Vdc)	12V	20A	95.2%	Through hole	150021143
EBVW020A0B641-HZ	48V (36-75Vdc)	12V	20A	95.2%	Through hole	150020433
EBVW020A0B9641-HZ	48V (36-75Vdc)	12V	20A	95.2%	Through hole	CC109172318
EBVW020A0B41-PHZ	48V (36-75Vdc)	12V	20A	95.2%	Through hole	CC109172334

Table 2. Device Options

	Characteristic	Character and Position	Definition
Ratings	Form Factor	E	E = Eighth Brick
	Family Designator	BV	BV = BARRACUDA Series, without PMBus interface
	Input Voltage	W	W = Wide Range, 36V-75V
	Output Current	020A0	020A0 = 020.0 Amps Maximum Output Current
	Output Voltage	B	B = 12.0V nominal
Options	Trim and Remote Sense Pins	9	Omit = Exclude Trim & Sense Feature and Pins 9 = Include Trim and Sense Feature and Pins
	Pin Length	8 6	Omit = Default Pin Length shown in Mechanical Outline Figures 8 = Pin Length: 2.79 mm ± 0.25mm, (0.110 in. ± 0.010 in.) 6 = Pin Length: 3.68 mm ± 0.25mm, (0.145 in. ± 0.010 in.)
	Action following Protective Shutdown	4	Omit = Latching Mode 4 = Auto-restart following shutdown (Overcurrent/Overvoltage)
	On/Off Logic	1	Omit = Positive Logic 1 = Negative Logic
	Customer Specific	XY	XY = Customer Specific Modified Code, Omit for Standard Code
	Optional Features	P H	Omit = Standard open Frame Module P = Forced Droop Output for use in parallel applications H = Heat plate, for use with heat sinks or cold-walls
	RoHS	Z	Omit = RoHS 5/6, Lead Based Solder Used Z = RoHS 6/6 Compliant, Lead free



LINEAGE POWER[®]

World Wide Headquarters
Lineage Power Corporation
601 Shiloh Road, Plano, TX 75074, USA
+1-888-LINEAGE(546-3243)
(Outside U.S.A.: +1-972-244-WATT(9288))
www.lineagepower.com
e-mail: techsupport1@lineagepower.com

Asia-Pacific Headquarters
Tel: +86.021.54279977*808

Europe, Middle-East and Africa Headquarters
Tel: +49.89.878067-280

India Headquarters
Tel: +91.80.28411633

Lineage Power reserves the right to make changes to the product(s) or information contained herein without notice. No liability is assumed as a result of their use or application. No rights under any patent accompany the sale of any such product(s) or information.

Lineage Power DC-DC products are protected under various patents. Information on these patents is available at www.lineagepower.com/patents.

© 2010 Lineage Power Corporation, (Plano, Texas) All International Rights Reserved.

Document No: DS11-023 ver 1.1
PDF Name: EBVW020A0B.pdf