

PIM300X Series; ATCA Board Power Input Modules

-38 to -75 Vdc; 300W Input

RoHS Compliant

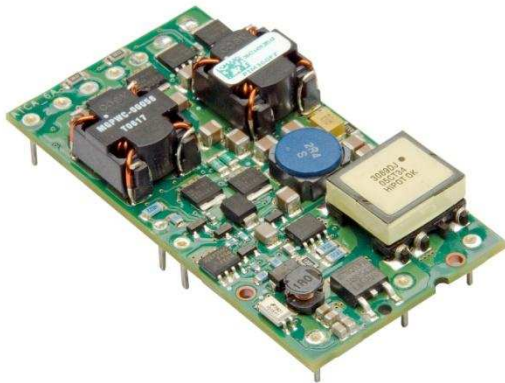

Applications

- ATCA Front Board / Blade
- Central Office Telecom equipment
- High availability server and storage applications

Options

- Choice of System Management Power:
 - 3.3Vdc (PIM300F)
 - 5.0Vdc (PIM300A)
- Choice of short pin lengths

Description

The PIM300X-series is the higher power version of its highly successful predecessor, the PIM200X series. Besides providing higher power over extended temperature range, the module is pin compatible and retains the same form factor as the PIM200X series for ease of upgrading to higher power or thermally challenging ATCA board designs. The PIM200X/300X series are a new class of power modules designed to greatly simplify the task of implementing dual redundant, hot swap -48Vdc power distribution with EMI filtering on an ATCA or other telecom boards. The PIM300X, when used with a variety of Lineage Power's dc-dc converters/POLs provides for a quick, simple and elegant power architecture solution to a wide variety of complex power requirements. While providing high reliability, innovative features and compact design at a low cost, the module significantly reduces the valuable telecom board real estate compared to conventional discrete designs. Besides processing the main -48V bus, the module greatly simplifies the task of powering the IPM (for ATCA applications), system management or other housekeeping functions by providing a completely isolated auxiliary 3.3V or 5.0V power bus.

Features

- 300W / -48V telecom input power distribution
- 8W (3.3Vdc or 5.0Vdc) of isolated Management Power for IPM or other housekeeping functions
- OR'ing functionality for the A/B & RTN power feeds as well as Enable A/B signals
- Inrush protection / hot swap capability
- Integral EMI filter designed for the ATCA board to meet CISPR Class B
- Independent 72Vdc output for charging the external holdup capacitors resulting in significant board real estate savings and bleed resistor power dissipation
- A/B Feed Loss or open fuse alarm (opto-isolated)
- Protection: Reverse polarity, under voltage, input transient over voltage, over current & over temperature
- High efficiency : 98% @ -48V / 300W (@25C)
- -5 to 85°C ambient temperature operation
- Compact design : 70.6 mm x 36.8 mm x 12.7 mm
(2.78 in x 1.45 in x 0.5 in)
- MTBF : 1,362,480 hours per TELCORDIA
- ISO** 9001 & ISO 14001 certified manufacturing facilities
- Compliant to RoHS EU Directive 2002/95/EC
- *UL** 60950-1 Recognized, *CSA*[†] C22.2 No. 60950-1-03 Certified, EN 60950-1 (*VDE*[‡] 0805: 2001-12) Licensed , CE
- Designed and tested for Basic Insulation (1500Vdc)

* *UL* is a registered trademark of Underwriters Laboratories, Inc.

[†] *CSA* is a registered trademark of Canadian Standards Association.

[‡] *VDE* is a trademark of Verband Deutscher Elektrotechniker e.V.

** *ISO* is a registered trademark of the International Organization of Standards

300W ATCA Board Typical Application

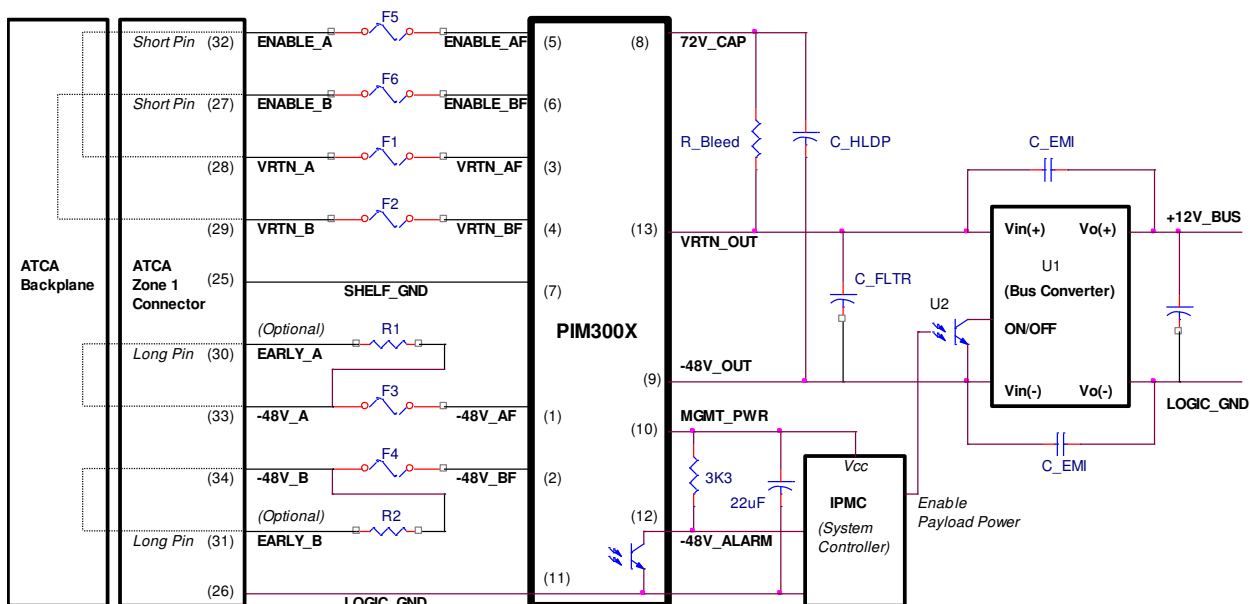

$$C_HLDP(\mu F) \geq [P_{out}(W) * \{T_{holdup}(ms) + 1.7\}] / 1.9$$

$$R_Bleed(\Omega) \leq 5.485 / C_HLDP(F)$$

Suggested Bill of Materials

(Note: Customer is ultimately responsible for the selection and verification of the suggested parts).

Qty	Ref Des	Description (Values)	MFR / PN (or equivalent)	Comments
2	F1, F2	Fuse, SMT, 12 Amp	Bel Fuse: SSQ Series	VRTN_A, VRTN_B
2	F3, F4	Fuse, SMT, 10 Amp	Littelfuse 451/ 453 Series	-48V_A, -48V_B
2	F5, F6	Fuse, SMT, 1/16th Amp	(Voltage rating >=75V)	ENABLE_A, ENABLE_B
2	C_FLTR	Capacitors, Al Electrolytic 100uF/100V	Nippon/Chemicon; KZE Series Panasonic: FK Series (SMT) Nichicon: UJ Series	C_FLTR(Max,Total) = 330 uF
4 OR 1	C_HLDP	Capacitors, Al Electrolytic 470uF/80V OR Capacitors, Al Electrolytic 1800uF/80V	Nippon/Chemicon; KZE Series Panasonic: FK Series (SMT) OR Panasonic / ECEC1KP182DL 30mm(OD) X 20mm(L)	C_HLDP(calculated)=1737 uF (for 300W & Tholdup=9.3msecs) Snap-In Radial
1	R_Bleed	SM, 2.9Kohms, 1W		For C_HLDP=1800uF
2	C_EMI	SM, 4700pF, >=1500V	Novacap, Murata or Syfer	Size: >=1210
1	U1	300W/12V Bus Converter	Lineage Power: QBW025A0B1	
1	U2	Opto-coupler (1500V)	Fairchild: HMHA2801	Safety approved
2	R1*, R2*	High Surge Power, 15 Ohms	KOA: SG73 (Size >=1206)	*Optional; See "Design Consideration" Section

Absolute Maximum Ratings:

Stresses in excess of the absolute maximum ratings can cause permanent damage to the device. These are absolute stress ratings only, functional operation of the device is not implied at these or any other conditions in excess of those given in the operations sections of the data sheet. Exposure to absolute maximum ratings for extended periods can adversely affect the device reliability.

Parameter	Device	Symbol	Min	Typ	Max	Unit
Input Voltage (Absolute values)						
Continuous	All	V_I	0	-48	-75	Vdc
Transient (Pulse duration above -75V = 1ms)	All	V_{tr}	-75		-100	Vdc
Temperature						
Normal Operating Ambient Temperature (See Thermal Considerations section)	All	T_A	-5		85	°C
Storage Temperature	All	T_{stg}	-55		125	°C
Power						
Input Power, Maximum Allowable	All	$P_{in,max}$			300	W
Input to Output Voltage Differential @ -48Vin & $P_{in,max}$, $T_A=25^\circ\text{C}$	All	V_{Δ}		0.8V		V
Efficiency VIN=-48V, $P_{in,max}$, $T_A=25^\circ\text{C}$ (MGMT_PWR=0W)	All	η		98		%
Power Dissipation (Internal Module Dissipation @ $P_{in,max}$ (with MGMT_PWR = 8W)	All	P_{diss}		12		W
Output Power, Maximum Deliverable (Management Power + Payload Power)	All	P_{out}		288		W
Management Power, Maximum Deliverable (MGMT_PWR)	All	P_{MGMT_PWR}			8	W
Module Standby Power (@-48Vin & MGMT_PWR=0W, $P_{out}=0W$)	All	P_{Stdby}		2.0		W
Isolation						
Input to MGMT_PWR Output Voltage	All				1500	Vdc
Input to SHELF_GND Voltage	All				1500	Vdc
Input to LOGIC_GND Voltage	All				1500	Vdc
LOGIC_GND to SHELF_GND Insulation Resistance with 100Vdc Test Voltage	All		9			MOhms

CAUTION: This power module is not internally fused. Both A & B feeds and their corresponding returns must be individually fused.

To preserve maximum flexibility, internal fusing is not included. However, to achieve maximum safety and system protection, the safety agencies require a fast-acting fuse with a maximum rating of 15 Amps and Voltage Rating \geq 75Vdc for the -48AF, -48BF VRTN_AF & VRTN_BF feeds. Consult Fusing and fault protection (Section 4.1.4) of PICMG 3.0 ATCA specifications for additional information. Based on the information provided in this data sheet on inrush current and maximum dc input current, the same type of fuse with a lower rating can be used. Refer to the fuse manufacturer's data sheet for further information.

Electrical Specifications:

Unless otherwise indicated, specifications apply over all operating input voltage, resistive load, and temperature conditions.

Parameter	Device	Symbol	Min	Typ	Max	Unit
Main Input (-48_AF,-48_BF,VRTN_AF,VRTN_BF); (Absolute values)						
Operating Input Voltage (Module will operate down to -36V depending on the output power and thermal environment but may not support holdup time requirements)	All	V_I	-38	-48	-75	Vdc
Input Voltage Turn-on Threshold (Module On)	All	V_{UVHI}	-34.3	-35.3	-36.0	Vdc
Under Voltage Lockout Threshold (Module Off)	All	V_{UVLO}	-32.4	-33.7	-34.1	Vdc
Maximum current drain if input voltage falls below V_{UVLO} for > 2 seconds.	All	I_{stdby}			10	mA
Maximum Input Current ($V_I=0V$ to -75Vdc, $P_{in}=P_{in,max}$)	All	$I_{I,max}$			9.0	Adc
Inrush Transient (@ -48 V_I and with $C_{FLTR} = 200\mu F$)	All	I_{pk}		20 ($<50\mu s$)		Adc
Duration: 0.1 to 0.9msecs (Per PICMG 3.0 specs.)		I_{pk}			44	Adc
Duration: 0.9 to 3 ms (Per PICMG 3.0 specs.) (Logarithmically declining)		I_{pk}			44 to 18	Adc
Duration: 3 to 100ms (Per PICMG 3.0 specs.)		I_{pk}		6.25	8.8	Adc
ENABLE A/B Signal Inputs (ENABLE_A, ENABLE_B)						
Enable A / B Signals current drain ($V_{in} = -75Vdc$)	All				700	μA_{dc}
Main Output (-48V_OUT, VRTN_OUT)						
External Output Filter Capacitance (C_{FLTR})	All	C_{FLTR}	200*		330	μF
72V Holdup Capacitor Output (72V_CAP)						
72V_CAP Output Voltage Tolerance	All		68.4	72.0	74.2	Vdc
72V_CAP ON (OR'd) Input Voltage Threshold			-36.2	-37.7	-39.2	Vdc
A/B Feed Loss / Fuse Alarm Output (-48V_ALARM)						
-48V_ALARM is an Opto-isolated open collector output with the emitter internally referenced to LOGIC_GND. Alarm Characteristics: Power Good / Fuse Good = LO (Opto conducting) A or B Feed Loss / Fuse (open) = HI (Opto off)	All					
Alarm ON Input Voltage Threshold			-36.1	-37.2	-38.2	Vdc
Opto Transistor Collector to Emitter Voltage		V_{ceo}			40	Vdc
Opto Transistor Collector to Emitter Dark Current (Opto Diode current, $I_d = 0A$)		I_{ceo}			100	nA
Opto Transistor Collector Current		I_c			5	mA
Opto Transistor Collector Saturation Voltage	$V_{CE(sat)}$			0.3	Vdc	

Note: * See "Design Considerations" section for further information.

Electrical Specifications (continued):

Parameter	Output Voltage	Symbol	Min	Typ	Max	Unit
Management Power Output (MGMT_PWR)						
Operating Input Voltage	3.3V/5.0V	V_I	-36	-48	-75	Vdc
Output Voltage Set-point ($V_I = -48\text{Vdc}$, $I_O = I_{O,max}$, $T_A = 25^\circ\text{C}$)	3.3V/5.0V	$V_{O,set}$	-2.0	—	+2.0	% $V_{O,set}$
Output Voltage (Over all operating input voltage, resistive Load and temperature conditions until end of life)	3.3V/5.0V	V_O	-3.0	—	+3.0	% $V_{O,set}$
Output Regulation Line ($V_I = V_{I,min}$ to $V_{I,max}$) Load ($I_O = I_{O,min}$ to $I_{O,max}$) Temperature ($T_A = T_{A,min}$ to $T_{A,max}$)	3.3V/5.0V		—	0.05	0.2	% $V_{O,set}$
Output Ripple and Noise Measured across 22 μF Tantalum/ceramic capacitor $V_I = V_{I,nom}$ $T_A = 25^\circ\text{C}$, $I_O = I_{O,max}$ RMS (5Hz to 20 MHz bandwidth) Peak-to-peak (5Hz to 20MHz bandwidth)	3.3V/5.0V		—	—	25	mV _{rms}
External Load Capacitance	3.3V/5.0V	$C_{O,max}$	0	—	1000	μF
Output Current	3.3V 5.0V	I_O	0	—	2.4	A _{dc}
Output Current-Limit Inception	3.3V 5.0V	$I_{O,lim}$		3	—	A _{dc}
Output Short-circuit Current (RMS)	3.3V 5.0V	$I_{O,sc}$	—	8	—	A _{rms}
Dynamic Response ($di/dt = 0.1\text{A}/\mu\text{s}$, $V_{in} = V_{in,nom}$, $T_A = 25^\circ\text{C}$) Load change from $I_O = 50\%$ to 75% of $I_{O,max}$, Peak Deviation Settling Time ($V_O < 10\%$ of peak deviation)	3.3V/5.0V	V_{pk} t_s		3 800	5	% $V_{O,set}$ μs
Turn-On Delay and Rise Times ($I_O = 80\%$ of $I_{O,max}$, $T_A = 25^\circ\text{C}$)	3.3V/5.0V	T _{delay}		20	50	msec
Output voltage overshoot ($I_O = 80\%$ of $I_{O,max}$, $V_I = 48\text{Vdc}$ $T_A = 25^\circ\text{C}$)	3.3V/5.0V				3%	% $V_{O,set}$
Output Over Voltage Protection	3.3V 5.0V	$V_{O,limit}$	3.7 5.6		5.4 7.0	V

General Specifications

Parameter	Min	Typ	Max	Unit
Calculated MTBF ($P_{in} = 80\%$ of $P_{in,max}$, $T_A = 40^\circ\text{C}$, $V_{in} = -48\text{Vdc}$) (Per Telcordia SR-332 Issue 1:Method 1 Case 3)		1,362,480		Hours
Weight	—	34 (1.2)	—	g (oz.)

PIM300X Internal Block Diagram

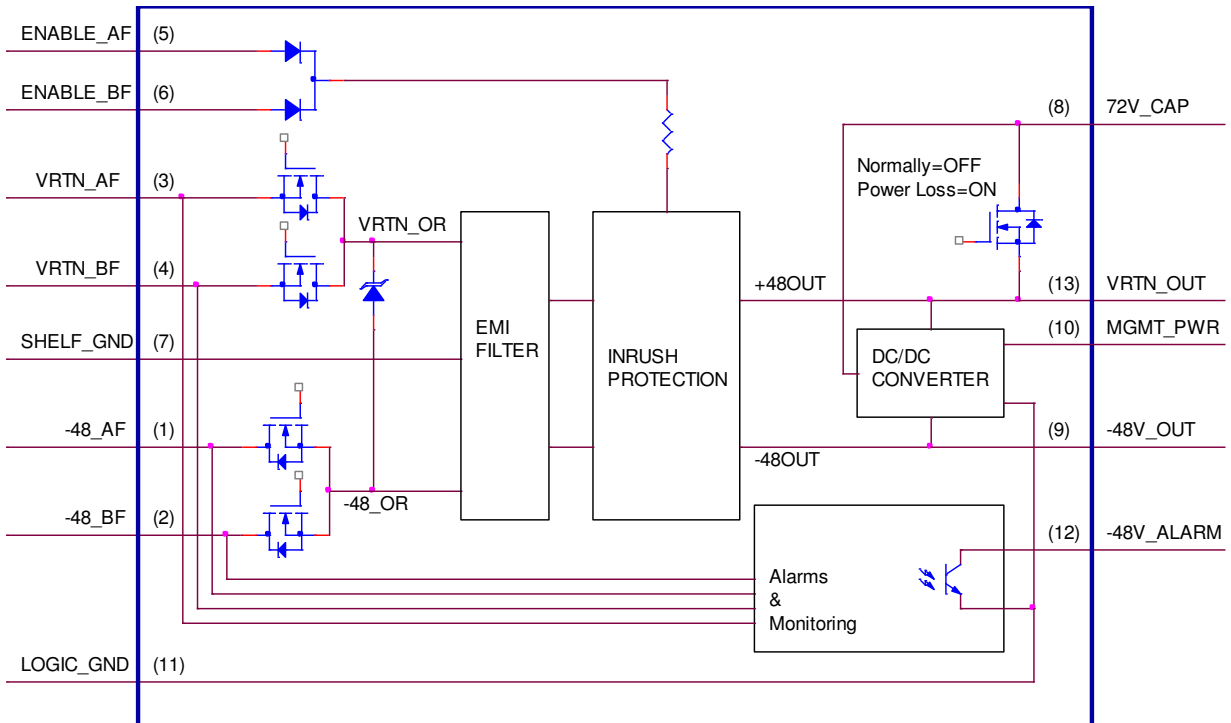

PIN FUNCTIONS

PIN NO.	PIN NAME	I/O	DESCRIPTION
1	-48_AF	I	-48V_A Feed (Externally Fused)
2	-48_BF	I	-48V_B Feed (Externally Fused)
3	VRTN_AF	I	VRTN_A Feed (Externally Fused)
4	VRTN_BF	I	VRTN_B Feed (Externally Fused)
5	ENABLE_AF	I	ENABLE_A Feed (Externally Fused) (Short Pin, connected to VRTN_A on the back plane)
6	ENABLE_BF	I	ENABLE_B Feed (Externally Fused) (Short Pin, connected to VRTN_B on the back plane)
7	SHELF_GND	I/O	Shelf / Chassis / Safety Ground
8	72V_CAP	O	Holdup/Bulk capacitor output voltage
9	-48V_OUT	O	OR'd and Inrush Protected -48V Output Bus
10	MGMT_PWR	O	3.3V / 5.0V Isolated Management Power Output (w.r.t LOGIC_GND)
11	LOGIC_GND	I/O	Logic / Secondary / Isolated Ground
12	-48V_ALARM	O	Opto-isolated -48V A/B Feed Loss or Open Fuse Alarm (w.r.t LOGIC_GND)
13	VRTN_OUT	O	OR'd and Inrush Protected VRTN Output Bus

Characteristic Curves

The following figures provide typical characteristics for the PIM300X modules at 25°C.

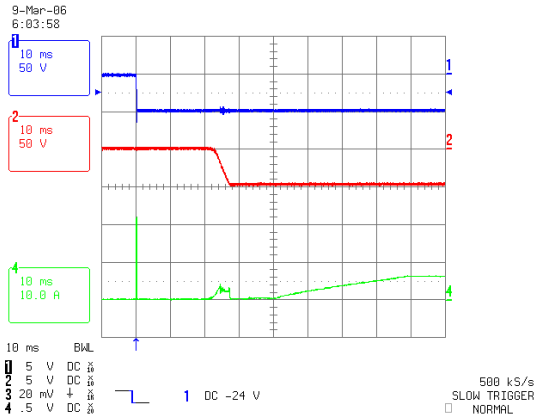

Figure 1. Inrush Current

CH1: -48_AF, CH2: -48V_OUT,
CH4: lin(-48_AF)

Test Conditions:

-48_AF=-48Vdc, -48V_BF=0Vdc
PIM300F @ Max Load (Pin=300W)
C_FLTR=200μF, C_HLDP=4X470μF

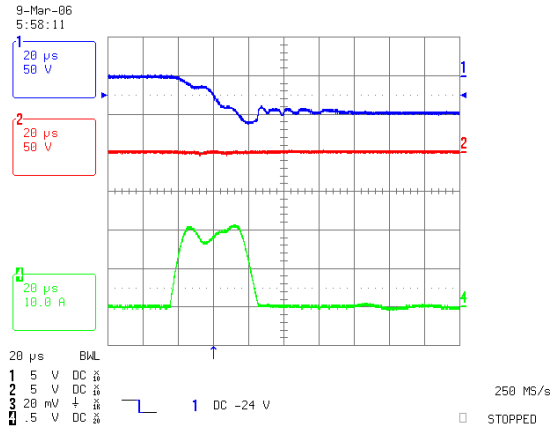

Figure 2. Inrush Current

(Expanded view of the first surge current)

CH1: -48_AF, CH2: -48V_OUT,
CH4: lin(-48_AF)

Test Conditions:

-48_AF=-48Vdc, -48V_BF=0Vdc
PIM300F @ Max Load (Pin=300W)
C_FLTR=200μF, C_HLDP=4X470μF

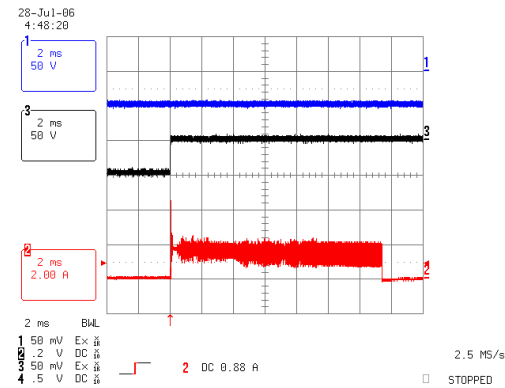

Figure 3. Power Up into Shorted Output

CH1: -48_AF, CH3: -48V_OUT,
CH2: lin(-48_AF)

Test Conditions:

-48_AF=-48Vdc, -48V_BF=0Vdc
PIM300F @ No Load
C_FLTR=200μF, C_HLDP=4X470μF

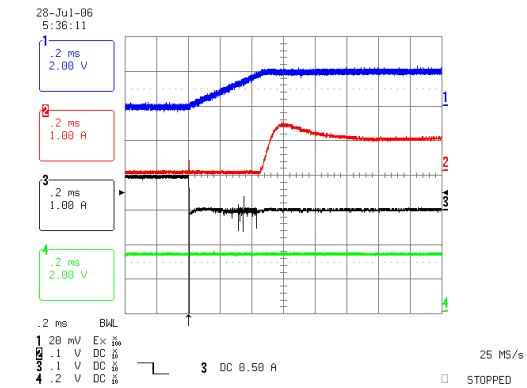

Figure 4. OR'ing Functionality when Feed B is shorted

CH1: -48V_OUT(AC), CH2: lin(-48_AF)
CH3: lin(-48_BF), CH4: 3.3V Output

Test Conditions:

-48_AF=-48Vdc, -48V_BF=-50Vdc
I(-48V_OUT) = 1A
C_FLTR=200μF, C_HLDP=4X470μF

Characteristic Curves (continued)

The following figures provide typical characteristics for the PIM300X modules at 25°C.

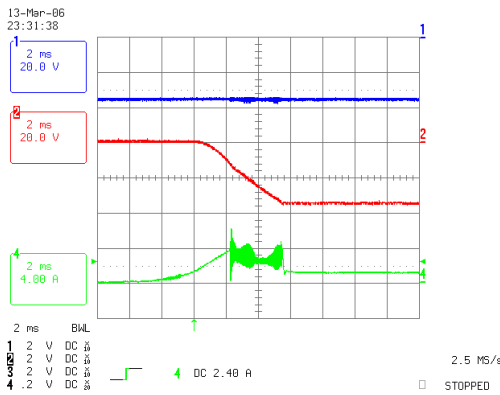

Figure 5. Input Voltage Turn-On Threshold
CH1: -48_AF, CH2: -48V_OUT,
CH4: lin(-48_AF)

Test Conditions:

-48_AF=-48Vdc, -48V_BF=0Vdc
I(-48V_OUT)=1A, I(MGMT_PWR)=0A
C_FLTR=200μF, C_HLDP=0μF

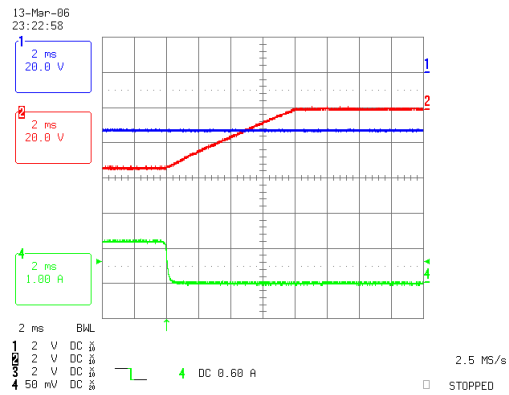

Figure 6. Input Voltage Turn-Off Threshold
CH1: -48_AF, CH2: -48V_OUT,
CH4: lin(-48_AF)

Test Conditions:

-48_AF=-48Vdc, -48V_BF=0Vdc
I(-48V_OUT)=1A, I(MGMT_PWR)=0A
C_FLTR=200μF, C_HLDP=0μF

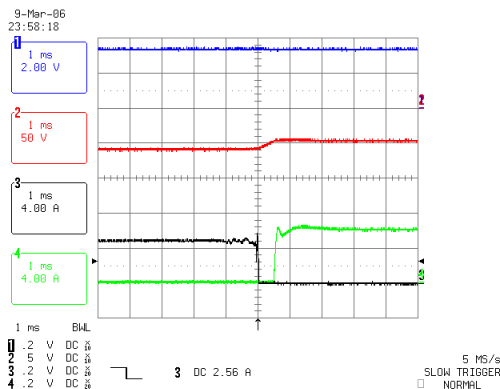

Figure 7. Loss of Feed A; Switchover to Feed B

CH1: MGMT_PWR, CH2: -48V_OUT,
CH3: lin(-48_AF), CH4: lin(-48V_BF)

Test Conditions:

1. Feed A (-48V_AF=60V) > Feed B (-48V_BF=48V)
2. Fast Loss of Feed A; Switchover to Feed B
3. PIM300F @ Max Load (Pin=300W)
4. C_FLTR=200μF, C_HLDP=4X470μF

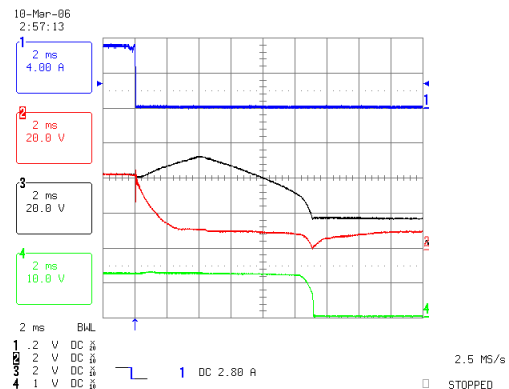

Figure 8. Holdup Performance; Loss of Feed A (with Feed B=0Vdc); Load=QBW
CH1: lin(-48V_AF), CH2: 48V_AF,
CH3: 48V_OUT, CH4: 12Vout

Test Conditions:

1. 48_AF= 43Vdc; 48V_BF=0 Vdc
2. Pin=300W; 12Vout=22.5A; 3.3V=2.42A
3. C_FLTR=200μF, C_HLDP=Qty4 X 470μF

Characteristic Curves (continued)

The following figures provide typical characteristics for the PIM300X modules at 25°C (unless specified otherwise).

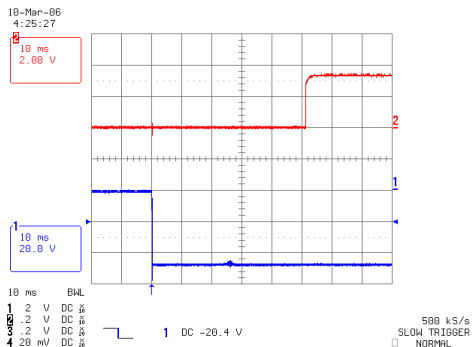

Figure 9. Typical Start-Up of MGMT_PWR(3.3Vdc) with application of -48Vin.

CH1: -48_AF
CH2: MGMT_PWR (3.3Vdc) Output

Test Conditions:

1. -48_AF=-48Vdc;
2. PIM300F @ Max Load (Pin=300W)
3. C_FLTR=200µF, C_HLDP=4X470µF

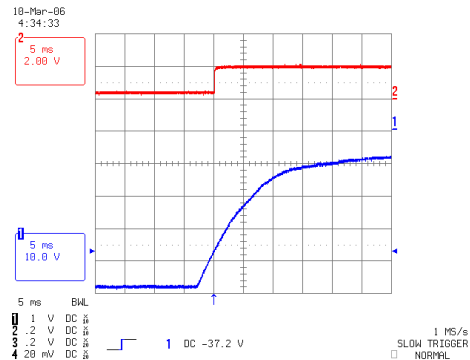

Figure 10. -48V_ALARM with Loss of Feed

CH1: -48V_AF
CH2: -48_ALARM

Test Conditions:

1. -48_AF=-48_BF= -48Vdc ;
2. PIM300F @ Max Load (Pin=300W)
3. C_FLTR=200µF, C_HLDP=4X470µF

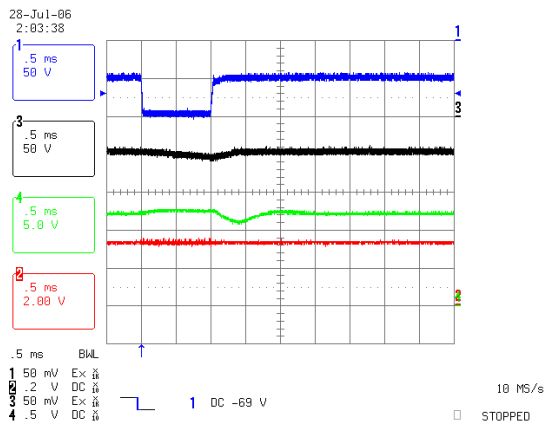

Figure 11. Input Transient Over voltage Protection for 100V/1ms transient

CH1: -48_AF, CH3: -48V_OUT, CH4: +12V Out
CH2: MGMT_PWR (3.3Vdc) Output

Test Conditions:

1. -48_AF=-48Vdc to -100V for 1msec
2. -48V_OUT Load: QBW025A0B1 Bus Converter
3. MGMT_PWR Load = 3.3V @ 2.5 Ohms

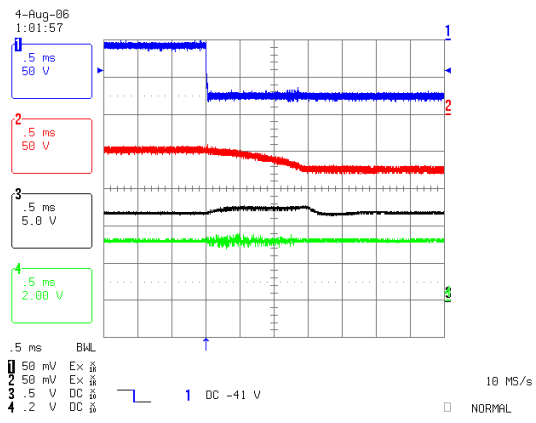

Figure 12. Feeds Switchover Test from -48V_Feed A to -75V_Feed B via Knife Switch

CH1: -48_BF, CH2: -48V_OUT, CH3: +12V Out
CH4: MGMT_PWR (3.3Vdc) Output

Test Conditions:

1. -48_AF=-48Vdc
2. -48_BF= 0 to -75Vdc via Knife Switch
3. -48V_OUT Load: QBW025A0B1 Bus Converter

Thermal Derating Curves

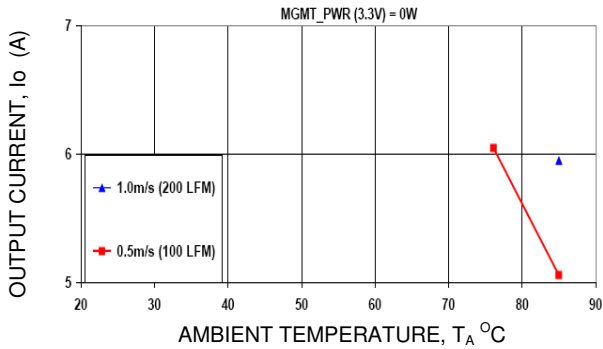

Figure 13-1. PIM300F Derating Output Current versus Local Ambient Temperature and Airflow
(Vin = -48Vdc; MGMT_PWR, 3.3V = 0W)

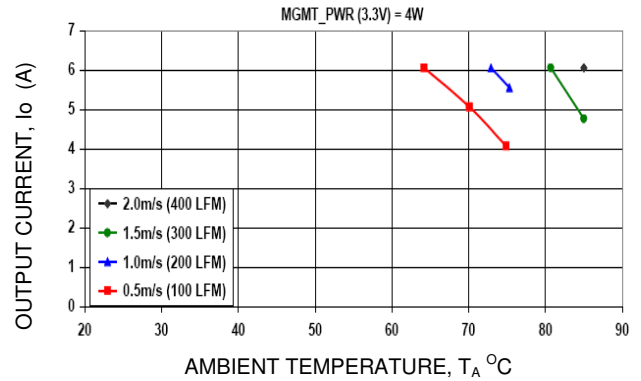

Figure 13-2. PIM300F Derating Output Current versus Local Ambient Temperature and Airflow
(Vin = -48Vdc; MGMT_PWR, 3.3V=4W)

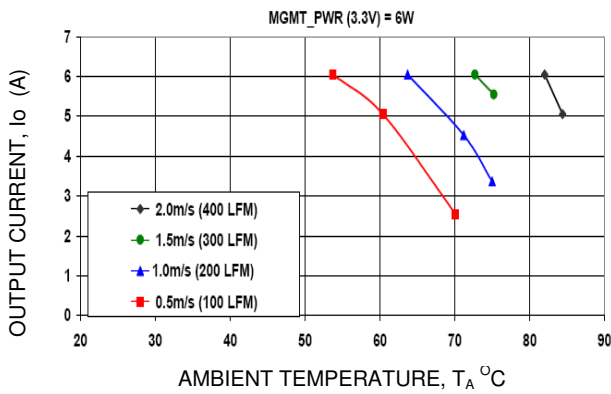

Figure 13-3. PIM300F Derating Output Current versus Local Ambient Temperature and Airflow
(Vin = -48Vdc; MGMT_PWR, 3.3V=6W)

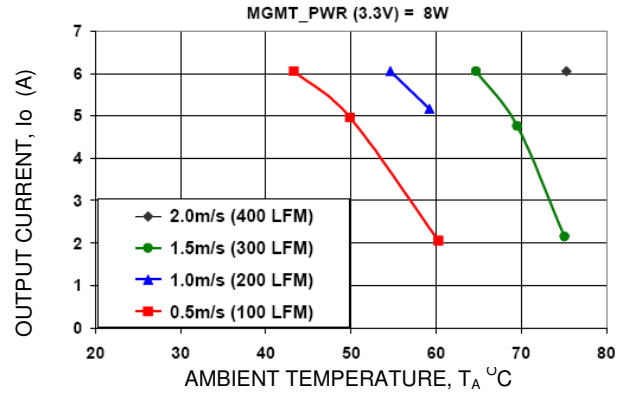

Figure 13-4. PIM300F Derating Output Current versus Local Ambient Temperature and Airflow
(Vin = -48Vdc; MGMT_PWR, 3.3V = 8W)

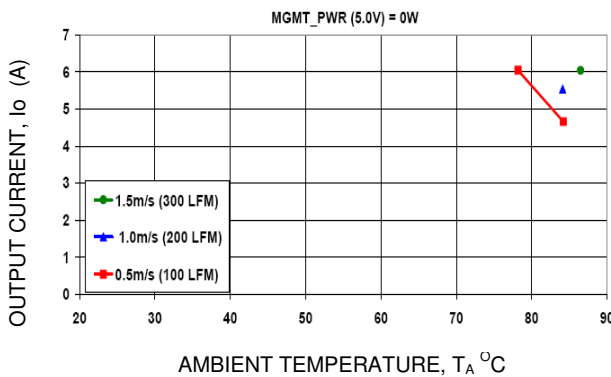

Figure 14-1. PIM300A Derating Output Current versus Local Ambient Temperature and Airflow
(Vin = -48Vdc; MGMT_PWR, 5.0V=0W)

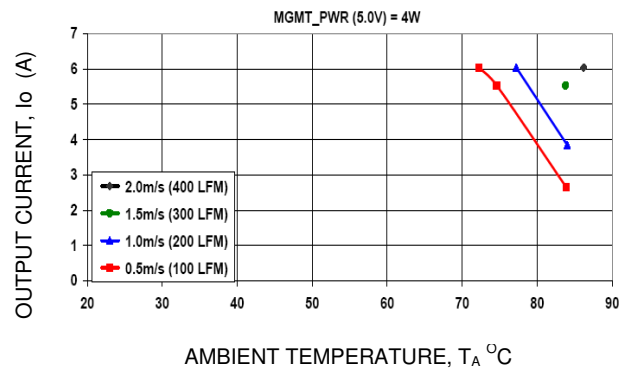

Figure 14-2. PIM300A Derating Output Current versus Local Ambient Temperature and Airflow
(Vin = -48Vdc; MGMT_PWR, 5.0V=4W)

Thermal Derating Curves (continued), Hot Spot & OTP Component Locations

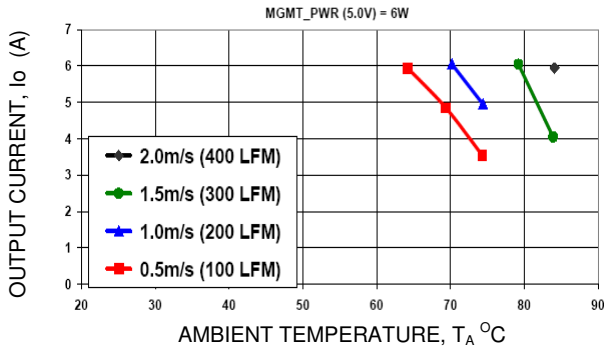

Figure 14-3. PIM300A Derating Output Current versus Local Ambient Temperature and Airflow (Vin = -48Vdc; MGMT_PWR, 5.0V = 6W)

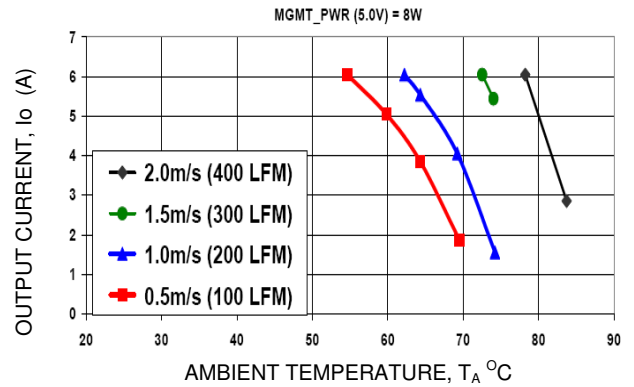

Figure 14-4. PIM300A Derating Output Current versus Local Ambient Temperature and Airflow (Vin = -48Vdc; MGMT_PWR, 5.0V=8W)

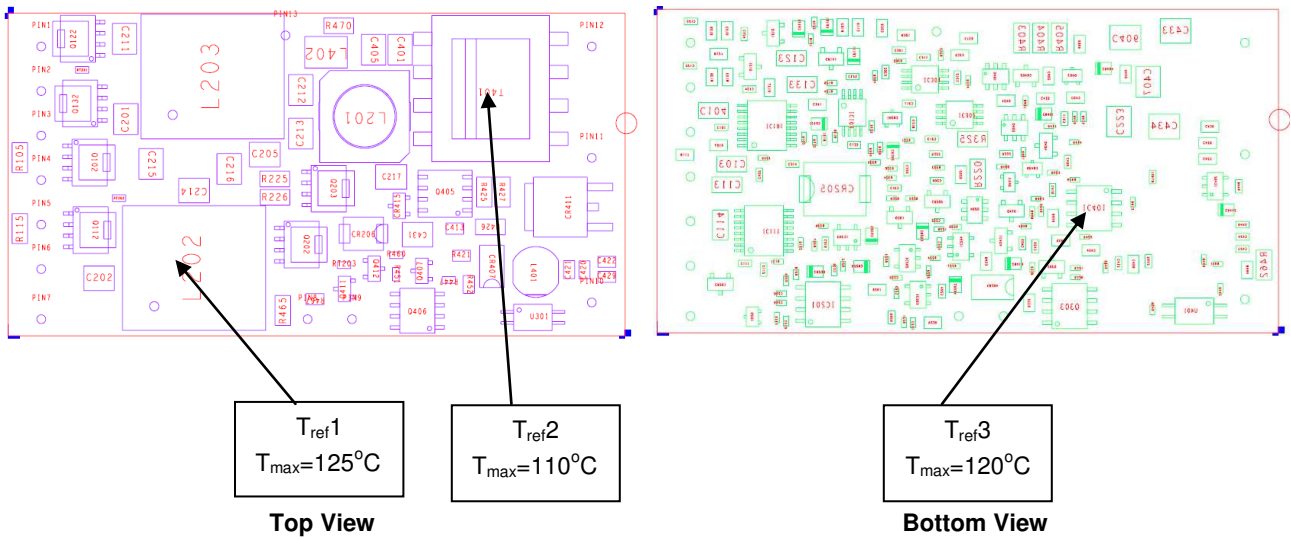

Figure 15. Thermal Reference Point, T_{ref} locations

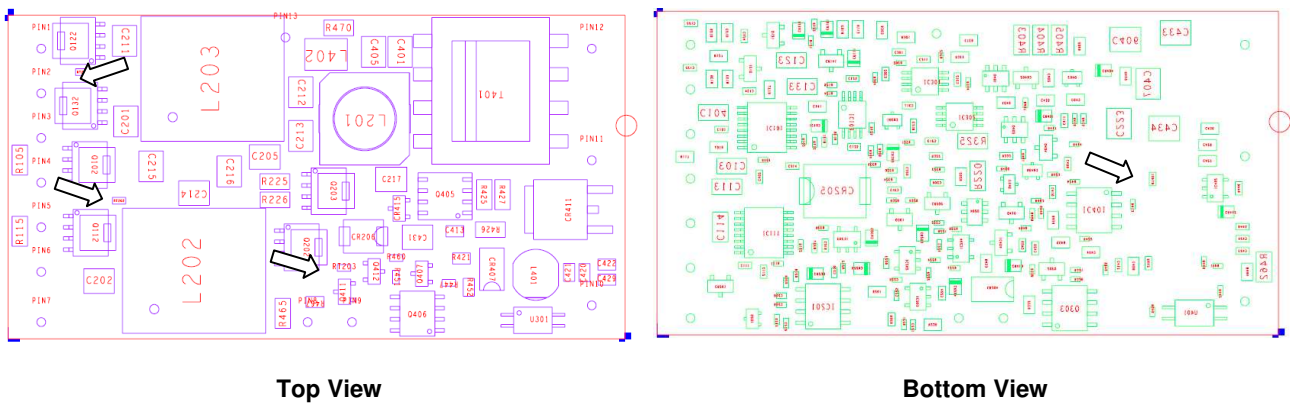

Figure 16. Location of Over Temperature Protection thermal sensors, T_{OTP} (Trip Point = 125°C +/- 5°C)

Design Considerations

Introduction

The PIM300X module is designed to support the Advanced Telecommunications Computing Architecture (ATCA) power entry distribution requirements for the Front Board / Blade per the PICMG 3.0 specifications.

The PICMG 3.0 specification defines the Mechanical, Shelf Management Interface, Power Distribution, Thermal, Data I/O and Regulatory requirements for the next generation of modular telecom architecture platform for use in Central Office telecom environments.

Input Pin Connections

The ATCA board is specified to accept up to a maximum of 300W of input power via dual, redundant -48Vdc Feeds through the Zone 1 (Power and Management) connector, designated P10.

The power connector provides board to backplane engagement via pins of varying lengths. Please consult the PICMG 3.0 specifications for details.

The following are the design considerations of the input pin connections of the PIM300X to the ATCA power connector.

From ATCA (P10 Connector)		Connection Requirement	To PIM300X	
Pin #	Pin Designation		Pin #	Pin Designation
33	-48V_A	Via Fuse(F3)	1	-48V_AF
34	-48V_B	Via Fuse(F4)	2	-48V_BF
28	VRTN_A	Via Fuse(F1)	3	VRTN_AF
29	VRTN_B	Via Fuse(F2)	4	VRTN_BF
30	EARLY_A*	Via Resistor(R1)	1	-48V_AF
31	EARLY_B*	Via Resistor(R2)	2	-48V_BF
32	ENABLE_A	Via Fuse(F5)	5	ENABLE_AF
27	ENABLE_B	Via Fuse(F6)	6	ENABLE_BF
26	LOGIC_GND	Direct	11	LOGIC_GND
25	SHELF_GND	Direct	7	SHELF_GND

* Optional

The first pins to mate in the ATCA power connector are the EARLY_A, EARLY_B, the two grounds (LOGIC_GND, SHELF_GND) and the two returns (VRTN_A, VRTN_B); followed by staggered connections of -48V_A and -48V_B power Feeds. The last pins to engage are the two short pins, ENABLE_A

& ENABLE_B. The ATCA backplane connects the ENABLE_A to VRTN_A, ENABLE_B to VRTN_B, EARLY_A to -48V_A and EARLY_B to -48V_B.

Optional EARLY_A & EARLY_B Connections:

During hot insertion of the ATCA board, the Inrush Control circuit limits the surge current to the C_FLTR capacitor. However, due to the presence of internal EMI filter capacitance (located before the Inrush Control circuit), there is a possibility of a surge current that results in a voltage sag for 5 to 10 microseconds. In most cases this should not be of concern because all the ATCA Boards and FRU's on the -48V bus should be able to ride thru a 5msec/0Volt transient event per the PICMG 3.0 specifications. In case this is undesirable, it is recommended that Precharge resistors, R1 & R2 (15 Ohms, with high surge capability) should be connected as shown in the Typical Application circuit.

Output Pin Connections

The out pin connections of the PIM300X to the system board is described below:

From PIM200X		To Board		Notes
Pin #	Pin Designation	Terminal	Component	
9	-48V_OUT	Vin(-)	DC/DC Converter	(1)
13	VRTN_OUT	Vin(+)	DC/DC Converter	(1)
8	72V_CAP	+ve	C_HLDP	(2)
10	MGMT_PWR	Vcc	IPM/ System Controller	(3)
12	-48V_ALARM			(4)

Notes:

(1) -48V Main Output Bus:

(Signal Names: -48V_OUT & VRTN_OUT)

This is the main -48V output bus that provides the payload power to the downstream (one or more) DC/DC converters. The PIM300X module does not regulate or provide isolation from the input -48V A/B feeds.

The main functionality of the module is to provide -48V A/B Feeds OR'ing, inrush protection for hot swap capability and EMI filtering to attenuate the noise generated by the downstream DC/DC converters.

- The -48V_OUT pin connects to the Vin(-) pin and the VRTN_OUT pin connects to the Vin(+) pin of the DC/DC converter(s).

- The -48V_OUT bus may require a fuse depending on the power and fusing requirements of the DC/DC converter.
- Input filtering of the DC/DC converter is provided by C_FLTR close to the input pins of the DC/DC converter(s); additional high frequency decoupling ceramic capacitors (0.01 to 0.1µF are recommended for improved EMI performance.
- The maximum C_FLTR capacitance across all the downstream DC/DC converters should not exceed 330µF. The recommended capacitor voltage rating should be $\geq 100Vdc$.
- The minimum C_FLTR capacitance (200µF) recommendation is based on meeting the EMI requirements. Based on end systems test, the capacitance may be lowered if real estate is an issue. As a minimum, 50 µF to 100 µF is strongly recommended to stabilize the line impedance for proper startup of the DC/DC converter. Refer to the DC/DC converter's data sheet for the recommended capacitor.

(2) Holdup / Bulk Capacitor Output (72V_CAP)

This output provides the high voltage (nominal 72Vdc) to charge the C_BULK capacitor(s) to allow the ATCA board to meet the 5ms, 0Volts transient requirements.

- The 72V_CAP connects to the +ve terminals of the C_HLDP capacitors while the -ve terminals of the C_HLDP connects to the -48V_OUT bus.
- Since the 72V_CAP output is regulated to 72Vdc (+3%/-5%) and the capacitors are off line during normal operation, the capacitors may be selected with voltage rating of $\geq 80V$ to minimize the real estate on the board.
- The C_HLDP capacitance is dependent on the system power and the holdup time requirements based on the following formula

$$C_HLDP(\mu F) \geq [P_{out}(W) * \{T_{holdup}(ms) + 1.7\}] / 1.9$$

- Bleed Resistor (R_Bleed) : The PICMG 3.0 specifications requires a discharge mechanism (e.g. bleed resistor) to discharge the holdup/bulk capacitance to less than -60Vdc and less than 20 joules within one second of disconnection from the backplane. This requirement is fulfilled by installing R_Bleed resistor that is selected based on the C_HLDP selected in the previous step. The formula for selecting the resistor is :

$$R_Bleed(\Omega) \leq 5.485 / C_HLDP(F)$$

For 300W and 9.3 ms holdup requirements, this results in a 2.9 Kohm resistor with 1W rating.

Worst case power dissipation of R_Bleed (=2.9Kohms) @ -36V is 0.45W.

- The R_Bleed is connected across the 72V_CAP and VRTN_OUT pins of the PIM300X.

(3) Management Power (MGMT_PWR)

The MGMT_PWR output is an isolated secondary voltage (3.3V for PIM300F or 5.0V for PIM300A) referenced to LOGIC_GND that provides 8W(maximum) power to the IPM Controller for the ATCA board or to the power up system controller for other applications.

- Per PICMG 3.0 Specs, the ATCA board **shall** not consume more than 10W of input power; this includes the standby power of PIM300X (typically 1.7W) as well as all the on board DC/DC power converters. It is the responsibility of the board designer to insure that this requirement is met prior to power-up rights have been negotiated with the Shelf Manager.
- The management power is available even when the input voltage is down to -36Vdc.
- No additional output capacitors are required, but a 22µF tantalum/ceramic and a 0.01 to 0.1µF ceramic capacitors are highly recommended to contain the switching ripple and noise.
- Higher output capacitance may be required in case of large input line or output load transient conditions.

(4) -48V Feed Loss or Open Fuse Alarm (-48V_ALARM)

The -48V_ALARM output is an opto-isolated signal internally referenced to the LOGIC_GND. The signal is an open collector output that requires an external pull up resistor. A 3.3K pull up resistor to 3.3V, MGMT_PWR (for PIM300F) should suffice. During normal operation, the signal is LO (opto conducting). During fault condition, the opto shall stop conducting and the alarm signal shall assume a HI state.

Safety Considerations

For the system safety agency approval the power module must be installed in compliance with the spacing and separation requirements of the end-use safety agency standards, i.e., UL 60950-1, CSA C22.2 No. 60950-1-03, and VDE 0850:2001-12 (EN60950-1) Licensed.

The power input to these units is to be provided with a maximum of 15 Amps fuses with a voltage rating of at least 75Vdc.

Refer to “Thermal Consideration” section for additional safety considerations.

Feature Description

A/B Feed OR'ing

The module provides dedicated OR'ing functionality to both Feeds A & B and their corresponding returns. The following pairs of signals are OR'd within the module:

-48V_AF / -48_BF, VRTN_AF / VRTN_BF, and ENABLE_AF/ ENABLE_B.

The -48V A/B feeds and their corresponding returns are OR'd via N-channel MOSFET power devices resulting in a highly efficient system compared to conventional diode OR'ing scheme.

EMI Filtering

The module incorporates an EMI filter that is designed for the ATCA board to help meet the conducted emissions requirements of CISPR 22 Class B when used in conjunction with Lineage Power DC/DC converters approved for ATCA applications. The following insertion loss table is provided as filter performance guidelines.

Parameter	Typical	Unit
Common-Mode Insertion Loss		
50 Ohms circuit, 200kHz	24	dB
50 Ohms circuit, 500kHz	32	dB
50 Ohms circuit, 1MHz	39	dB
Differential-mode Insertion Loss		
50 Ohms circuit, 200kHz	75	dB
50 Ohms circuit, 500kHz	66	dB
50 Ohms circuit, 1MHz	61	dB

The following Figure 17 depicts the Class B EMI performance of PIM300F when tested with QBW025A0B1 on a stand alone basis (ATCA form factor load board with resistive loads and only power, return and chassis connections to the backplane). The external filtering components are identified in the Typical Application circuit.

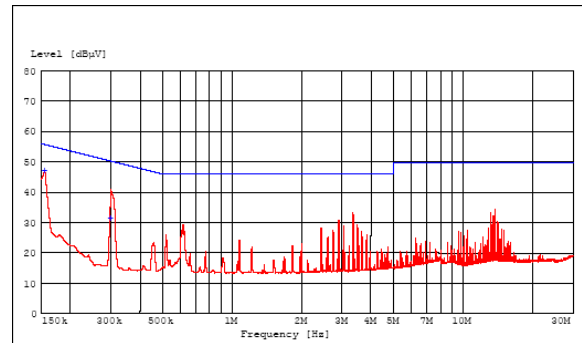

Figure 17. Typical Class B EMC signature of PIM300F with QBW025A0B1 module.

For Safety and noise considerations, copper traces must not be routed directly beneath the power module (PWB top layer). C_EMI capacitors must make direct connections (preferably without vias) to the DC/DC module pins with as much copper width as possible. In case vias are necessary, allow for multiple connections to the inner plane with vias placed outside the footprint of the module. For additional layout guide-lines, refer to Lineage Power's FLT007A0 Input Filter Module data sheet.

Inrush Current Control / Hot Plug Functionality

The module provides inrush current control / hot plug capability. The peak value of the inrush current and the duration complies with the PICMG 3.0's Inrush Transient specifications. The specifications shall be met with the external C_HLDP and C_FLTR capacitances as specified in the previous sections.

The unique design of the module where the large energy storage capacitors are segregated from the input filter capacitors allows the module to meet the stringent PICMG's inrush transient specifications. In conventional designs where the energy storage capacitors and the filter capacitors are in parallel, it is extremely difficult to meet the inrush transient specifications without over sizing the inrush control power FET.

A/B Feed / Fuse Alarm (-48V_ALARM)

The module monitors the A & B feeds as well as the status of the A&B feed fuses and provides an opto-isolated signal in case of loss of a feed or the opening of any of the fuses. The response time of the fault condition is < 100 µsec. The alarm signal indicates normal operation when the opto coupler transistor is conducting and a fault condition by an off state.

Holdup Capacitor Charging Current (72V_CAP)

The module employs a unique feature to charge and recharge the external energy storage holdup/bulk capacitors (C_HLDP) within seconds from the application of power to a nominal voltage of 72Vdc (+3%/-5%) resulting in significant reduction in the real estate on the board in order to comply with the PICMG 3.0's 0 volt/5msec transient requirements. Since the 72V_CAP is also regulated, there is further reduction in real estate board because now 80V capacitors with higher capacitance can be used instead of the ≥ 100 Vdc caps required in conventional designs. The maximum rate of input voltage change (dv/dt) shall not exceed 5V/ms when the -72V_CAP output is switched on the -48V_OUT/VRTN_OUT bus.

The holdup capacitors are switched on automatically when there is a loss of power on both feeds A & B or both feeds have dropped below -38V (typical).

Upon restoration of normal power on either or both feeds, the holdup capacitors automatically go off line and are recharged for the next power loss event.

Note 1: The holdup capacitors and the bleed resistor are installed external to the module.

Note 2: The PICMG 3.0's requirements for the 0 Vdc transient for 5ms is normally interpreted as the holdup time requirement by many. In actuality, when one considers the additional specification of 50V/ms fall time and 12.5 V/ms rise time to and from the 0Vdc condition, this leads to a 9.3ms of total hold up time requirement when power is interrupted at -43Vdc. The 72V_CAP output provided by the module to charge the bulk capacitors provides a tremendous advantage over conventional designs in terms of real estate requirements on the board with the added benefit of the usage of 80V capacitor rating vs ≥ 100 V.

The holdup time, T_{holdup} , is defined for power loss at -43Vdc input and the C_HLDP maintaining -48V_OUT bus to at least -36Vdc (which is the minimum operating voltage of the downstream DC/DC bus converter).

Note 3: Bleed Resistor (R_Bleed): Normally, the bleed resistor is not required as there is sufficient standby current drain within the module to bleed the holdup capacitors from 75V to 60V in 1 second as specified in the PICMG 3.0. Again, due to the PIM300X's unique design, the placement of the bleed resistor results in significantly less power dissipation compared with conventional designs where the bleed resistor is sized for -75Vdc continuous maximum voltage and -100V transients.

Over Current Protection (- 48V_OUT Bus)

To provide protection in a fault (output overload or short circuit) condition, the unit is equipped with

internal current-limiting circuitry. The unit can endure current overload conditions continuously or shutdown due to thermal protection depending on operating ambient temperature conditions. The unit will restart automatically once the overload condition is removed.

Input Under Voltage Lockout

At input voltages below the input under voltage lockout threshold limit (V_{UVLO}), the module operation is disabled. The module will begin to operate at an input voltage above the under voltage lockout turn-on threshold (V_{UVHI}). Please see the Electrical Specifications Table for the specified trip points.

Transient Over Voltage Protection

The module incorporates a Transient Voltage Suppressor. This feature helps protect the module and the downstream DC/DC converters from input voltage transients exceeding -75Vdc. The TVS is rated for 1500W of Peak Pulse Power with the Breakdown Voltage (V_{BR}) of 77.8V to 86.0V.

Input Reverse Polarity Protection

The module shall not be damaged from reverse polarity connection in the event of miswiring of either input feeds at the shelf input terminals.

Over Temperature Protection

To provide over temperature protection in a fault condition, the unit will shutdown if any thermal sensor reference point T_{OTP} (identified in Figure 16), exceeds the trip point of 125°C (+/- 5°C). The thermal shutdown is not intended as a guarantee that the unit will survive temperatures beyond its rating. The module will automatically restart after it cools down.

During thermal design verification, it is recommended that these temperatures be monitored by IR Thermal imaging camera. In case thermocouples are used, the thermocouple contacts should be attached as close as possible to the thermal sensors (thermistors) on the PWB but not directly on the thermistors themselves. Attaching the contacts directly to the thermocouple is not recommended as this will result in false temperature measurements due to the heat sink effect of the thermocouple wires.

Management Power (MGMT_PWR)

- The module provides up to 8W of 3.3V (PIM300F) or 5.0V (PIM300A) of isolated output power referred to LOGIC_GND.
- The management power is available automatically as soon as the input voltage levels are within -36Vdc to -75Vdc.
- The output is short circuit and over voltage protected with low ripple and noise.

Thermal Considerations

Power modules operate in a variety of thermal environments; however, sufficient cooling should be provided to help ensure reliable operation.

Considerations include ambient temperature, airflow, module power dissipation, and the need for increased reliability. A reduction in the operating temperature of the module will result in an increase in reliability. The thermal data presented here is based on physical measurements taken in a wind tunnel. The test set-up is shown below in Figure 18.

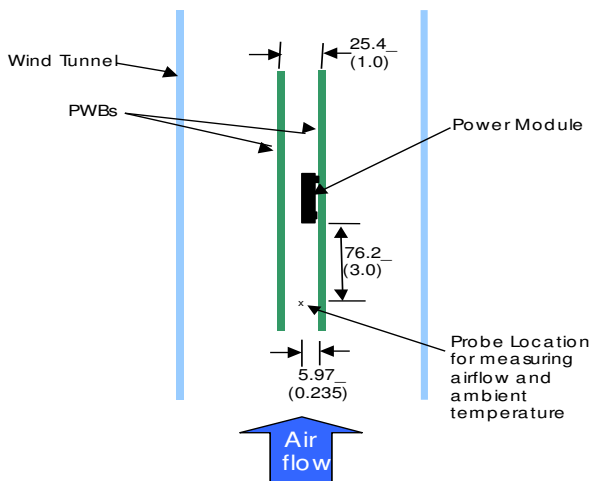

Figure 18. Thermal Test Set-up

The thermal derating curves were generated with the airflow parallel to the long axis of the module (input to output).

The thermal reference points, $T_{ref 1}$ to $T_{ref 3}$ are identified in Figure 15. For reliable operation and to comply with the module's safety requirements, these temperatures should not exceed the limits specified in the figure. Exceeding these temperatures may or may not trigger the over temperature shutdown. The output power of the module should not exceed the rated input power of the module i.e. 300W.

Please refer to the Application Note "Thermal Characterization Process For Open-Frame Board-Mounted Power Modules" for a detailed discussion of thermal aspects including maximum device temperatures.

Heat Transfer via Convection

Increased airflow over the module enhances the heat transfer via convection. Thermal derating curves

showing the maximum output current that can be delivered by the module versus local ambient temperature (T_A) are shown in the Thermal derating curves, Figs 13-1 to 13-4 for PIM300F and Figs 14-1 to 14-4 for PIM300A.

Manufacturing Considerations

Through-Hole Lead Free Soldering Information

The RoHS-compliant through-hole products use the SAC (Sn/Ag/Cu) Pb-free solder and RoHS-compliant components. They are designed to be processed through single or dual wave soldering machines. The pins have an RoHS-compliant finish that is compatible with both Pb and Pb-free wave soldering processes. A maximum preheat rate of 3°C/s is suggested. The wave preheat process should be such that the temperature of the power module board is kept below 210°C. For Pb solder, the recommended pot temperature is 260°C, while the Pb-free solder pot is 270°C max. If additional information is needed, please consult with your Lineage Power representative for more details.

Post Solder Cleaning and Drying Considerations

Post solder cleaning is usually the final circuit-board assembly process prior to electrical board testing. The result of inadequate cleaning and drying can affect both the reliability of a power module and the testability of the finished circuit-board assembly. For guidance on appropriate soldering, cleaning and drying procedures, refer to Lineage Power's Electronics *Board Mounted Power Modules: Soldering and Cleaning* Application Note (AP01-056EPS)

Mechanical Outline

Dimensions are in millimeters and (inches).

Tolerances: x.x mm ± 0.5 mm (x.xx in. ± 0.02 in.) [unless otherwise indicated]

x.xx mm ± 0.25 mm (x.xxx in ± 0.010 in.)

TOP VIEW

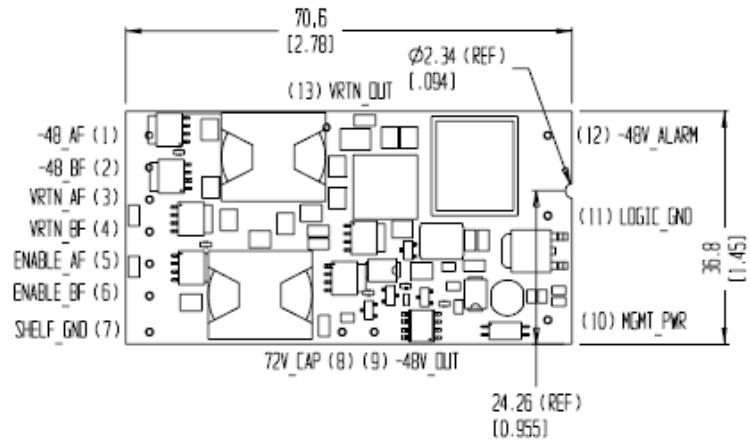

SIDE VIEW

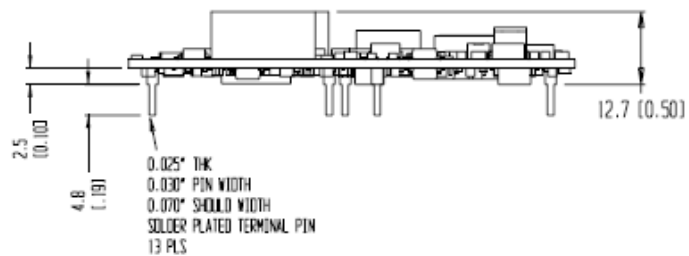

BOTTOM VIEW

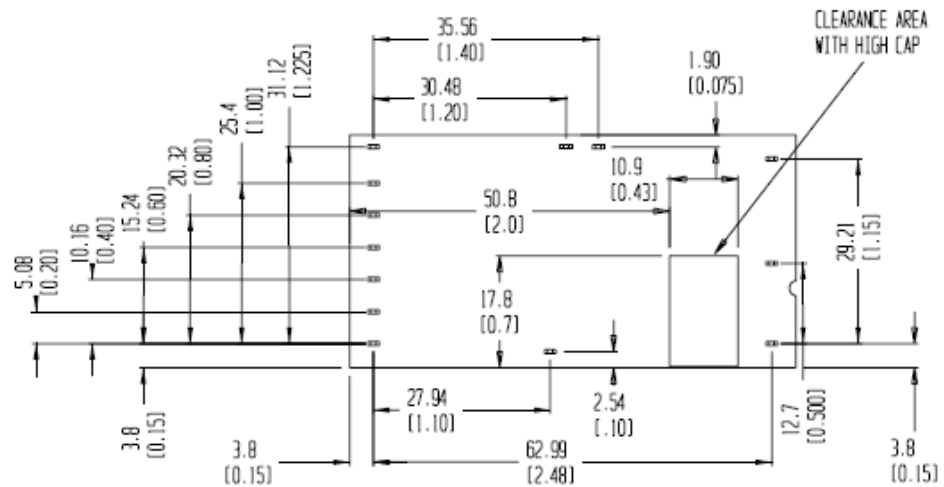

Ordering Information

Please contact your Lineage Power's Sales Representative for pricing, availability and optional features.

Table 1. Device Code

Input Voltage	Power Rating	Auxiliary Output Voltage	Auxiliary Output Current	Connector Type & Options	Product codes	Comcodes
-38 to -75 Vdc	300W	3.3Vdc	2.4A	Thru Hole/RoHS	PIM300FZ	CC109113858
-38 to -75 Vdc	300W	5.0Vdc	1.6A	Thru Hole/RoHS	PIM300AZ	CC109122322
-38 to -75 Vdc	300W	3.3Vdc	2.4A	Thru Hole/RoHS	PIM300F6Z	CC109159190

Table 2. Device Options

Option	Device Code Suffix
Short pins: 3.68mm ± 0.25mm (0.145 in. ± 0.010 in.)	6
Short pins: 2.79mm ± 0.25mm (0.110 in. ± 0.010 in.)	8

Table 3. Related Products

Description	Product Code	Comcode
PIM Evaluation Board	N/A	848755868
300W Bus converter; 36-75Vdc Input, 12Vdc / 25A Output	QBW025A0B1	CC109102464
300W Bus converter; 36-75Vdc Input, 12Vdc / 25A Output (With Heat Plate & RoHS compliant)	QBW025A0B1-HZ	CC109113643
300W Bus converter; 36-75Vdc Input, 12Vdc / 25A Output (With Basic Insulation & RoHS compliant)	QBW025A0B1-BZ	TBD
200W Bus converter; 36-75Vdc Input, 12Vdc / 18A Output	QBW018A0B1	108989356
200W Bus converter; 36-75Vdc Input, 12Vdc / 18A Output (RoHS compliant)	QBW018A0B1Z	TBD
200W Bus converter; 36-75Vdc Input, 12Vdc / 18A Output (RoHS compliant; specifically designed for high capacitance loads e.g. VRMs)	QBW018A0B1-TZ	CC109101846



World Wide Headquarters
Lineage Power Corporation
601 Shiloh Road, Plano, TX 75074, USA
+1-888-LINEAGE(546-3243)
(Outside U.S.A.: **+1-972-244-WATT(9288)**)
www.lineagepower.com
e-mail: techsupport1@lineagepower.com

Asia-Pacific Headquarters
Tel: +86.021.54279977*808

Europe, Middle-East and Africa Headquarters
Tel: +49.89.878067-280

India Headquarters
Tel: +91.80.28411633

Lineage Power reserves the right to make changes to the product(s) or information contained herein without notice. No liability is assumed as a result of their use or application. No rights under any patent accompany the sale of any such product(s) or information.

Lineage Power DC-DC products are protected under various patents. Information on these patents is available at www.lineagepower.com/patents.

© 2010 Lineage Power Corporation, (Plano, Texas) All International Rights Reserved.
