

## EMI filter and ESD protection

### Features

- EMI symmetrical (I/O) low-pass filter
- High efficiency in EMI/ESD protection
- Lead-free package
- Very thin package
- High reliability offered by monolithic integration
- High reduction of parasitic elements through integration and wafer level packaging

### Complies with the following standards

- IEC 61000-4-2 level 4  
(on external pins B1 and C1):
  - $\pm 15$  kV (air discharge)
  - $\pm 8$  kV (contact discharge)
- IEC 61000-4-2 level 1  
(on external pins):
  - $\pm 2$  kV (air discharge)
  - $\pm 2$  kV (contact discharge)

### Applications

Where EMI filtering in ESD sensitive equipment is required:

- Mobile phones and communication systems
- Computers, printers and MCU Boards

### Description

The EMIF02-MIC07F3 chip is a highly integrated audio filter device designed to suppress EMI/RFI noise in all systems subjected to electromagnetic interference.

This filter includes ESD protection circuitry, which prevents damage to the protected device when subjected to ESD surges up to 15 kV.

TM: IPAD is a trademark of STMicroelectronics.

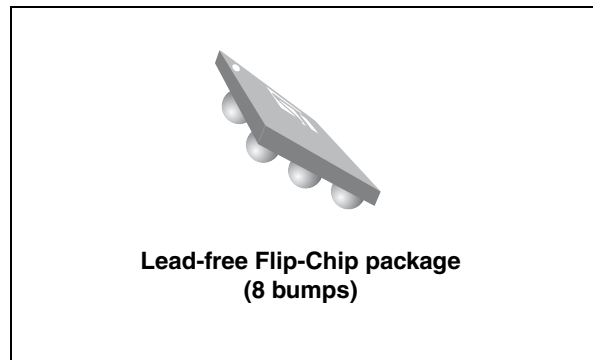
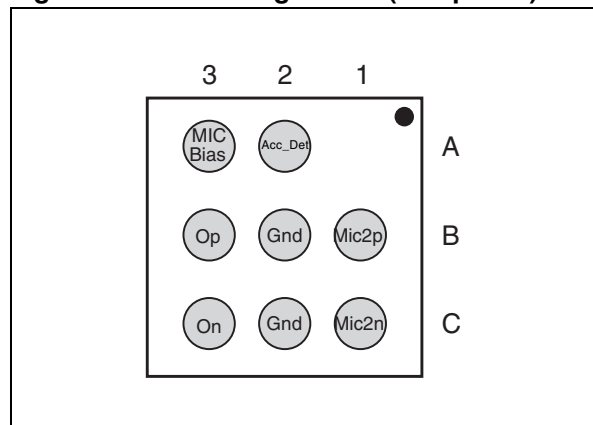
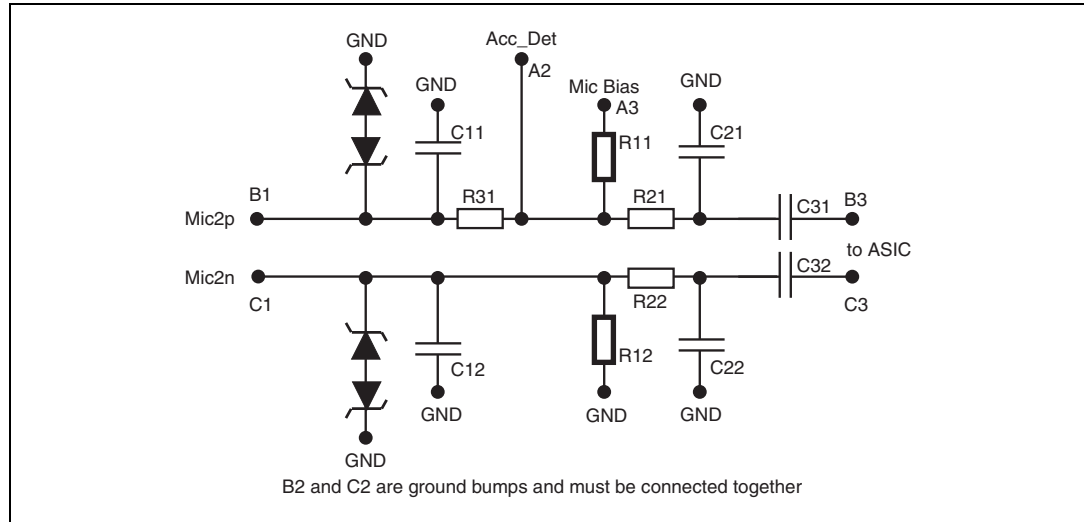

Figure 1. Pin configuration (bump side)



# 1 Characteristics

Figure 2. Configuration



### Acc\_Det pin connection

The Acc\_Det pin (accessory detection) is an input pin for the audio pre-amplifier chip which detects the voltage of the microphone line MIC2P in case the user presses the on-hook/off-hook button on the headset. When the user selects off-hook using the headset button, the MIC2P is shorted to MIC2N which is grounded. If your design does not support the Acc\_Det feature, the Acc\_Det pin must be left open (not connected).

Table 1. Absolute ratings (limiting values)

Symbol	Parameter and test conditions	Value	Unit
$V_{PP}$	<b>Pins B1 and C1, ESD discharge IEC 61000-4-2, level 4:</b>		
	air discharge	15	kV
	contact discharge	8	
	<b>Pins A2, A3, B3, C3, ESD discharge IEC 61000-4-2, level 1</b>		
	air discharge	2	
	contact discharge	2	
$P_D$	Power dissipation at $T_{amb} = 25\text{ °C}$	60	mW
$T_{op}$	Operating temperature range	- 40 to + 85	°C
$T_{stg}$	Storage temperature range	- 55 to + 150	°C

**Figure 3. Electrical characteristics (definitions)**

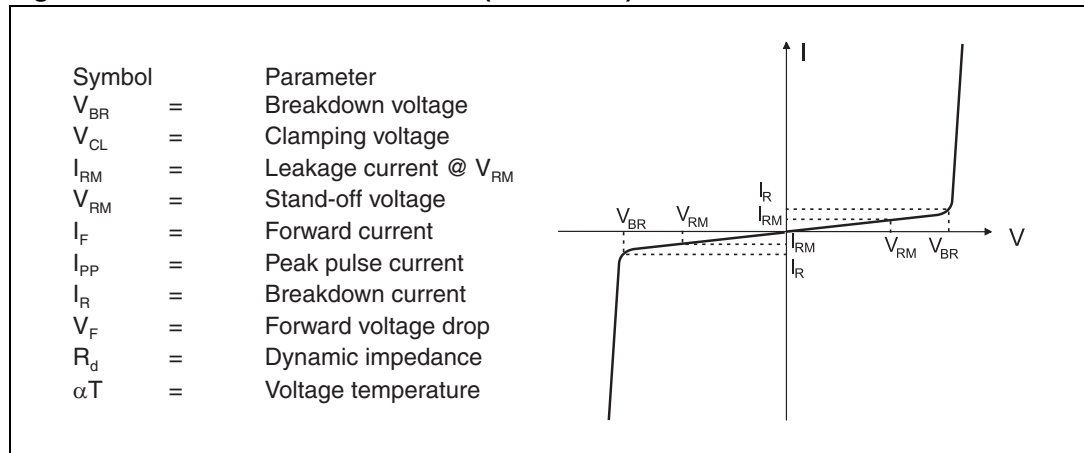

**Table 2. Electrical characteristics - values ( $T_{amb} = 25\text{ }^\circ\text{C}$ )**

Symbol	Test conditions	Min.	Typ.	Max.	Unit
$V_{BR}$	$I_R = 1\text{ mA}$	7			V
$I_{RM}$	$V_{RM} = 3\text{ V per line}$		50	200	nA
$R_{11}$		1900	2000	2100	$\Omega$
$R_{12}$		800	1000	1200	
$R_{21}, R_{22}$		1760	2200	2640	
$R_{31}$		20	25	30	
$C_{11}, C_{12}$	$V_{line} = 0\text{ V}, V_{osc} = 30\text{ mV}, F = 1\text{ MHz}$ (measured under zero light conditions and with bumps B2 and C2 connected together)	0.66	0.83	1	nF
$C_{21}, C_{22}$		1	1.25	1.5	
$C_{31}, C_{32}$		7	8.75	10.5	

**Table 3. Dynamics characteristics ( $T_{amb} = 25\text{ }^\circ\text{C}$ )<sup>(1)</sup>**

Symbol	Condition	Max. Value	Unit
Ripple	Between 5 KHz and 20 kHz	2	dB
THD+N	-21dBV fully differential between MICn and MICp 1kHz	0.009	%

1. Dynamics characteristics are guaranteed by design and not production tested

Figure 4. Attenuation versus frequency

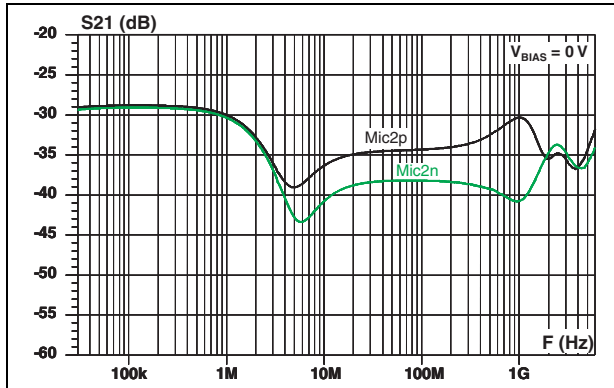

Figure 5. Attenuation simulation with 2 kΩ input and 47 kΩ output

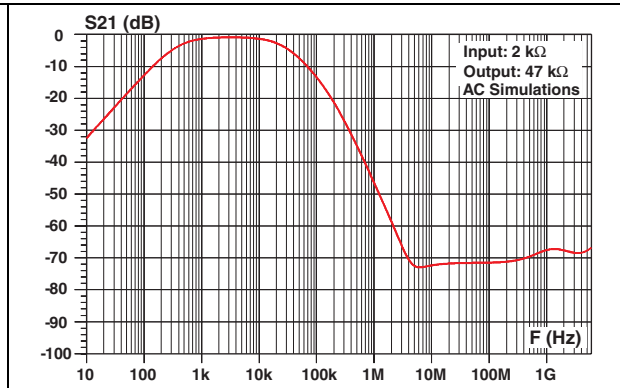

Figure 6. Analog crosstalk measurement

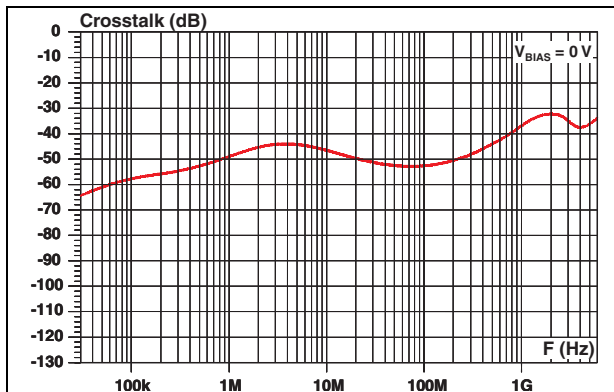

Figure 7. ESD response to IEC 61000-4-2 on one input  $V_{(in)}$  and on one output  $V_{(out)}$

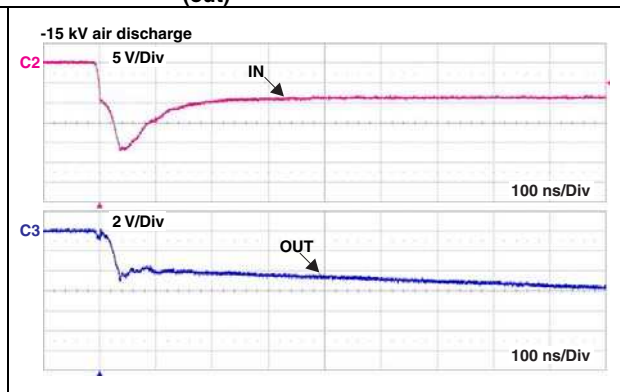

Figure 8. ESD response to IEC 61000-4-2 on one input  $V_{(in)}$  and on one output  $V_{(out)}$

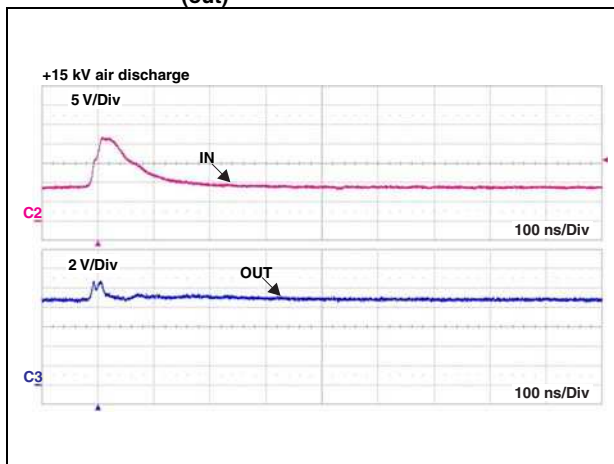
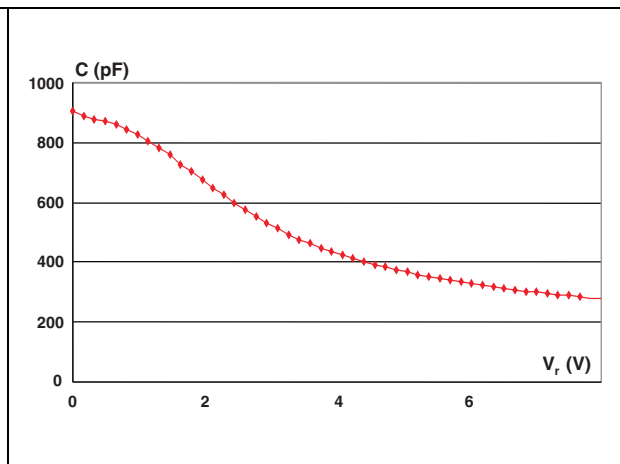
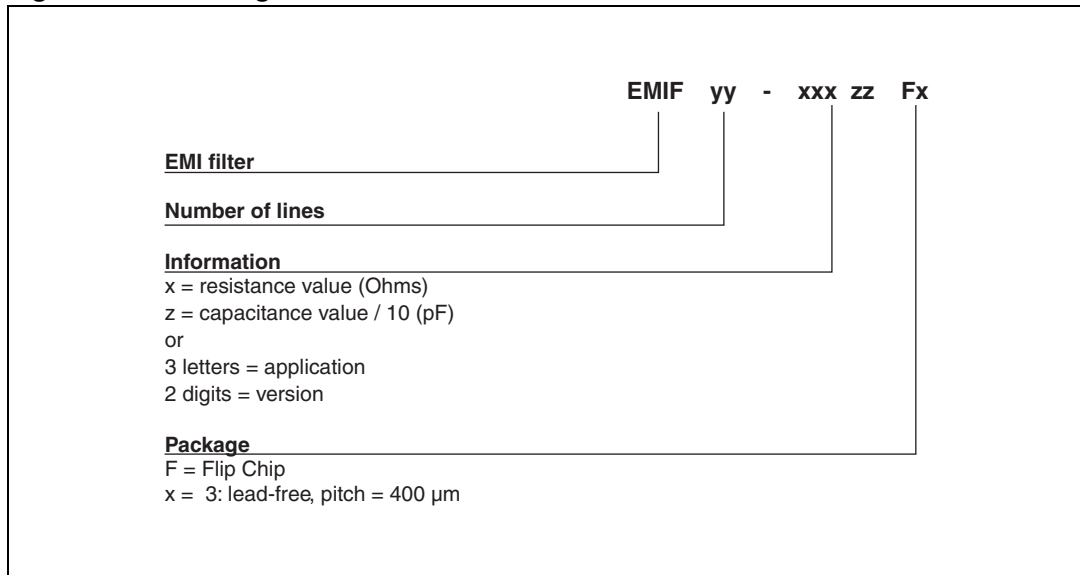

Figure 9. Line capacitance versus applied voltage (C11)



## 2 Ordering information scheme

Figure 10. Ordering information scheme



### 3 Package information

In order to meet environmental requirements, ST offers these devices in different grades of ECOPACK® packages, depending on their level of environmental compliance. ECOPACK® specifications, grade definitions and product status are available at: [www.st.com](http://www.st.com). ECOPACK® is an ST trademark.

**Figure 11. Flip-Chip package dimensions**

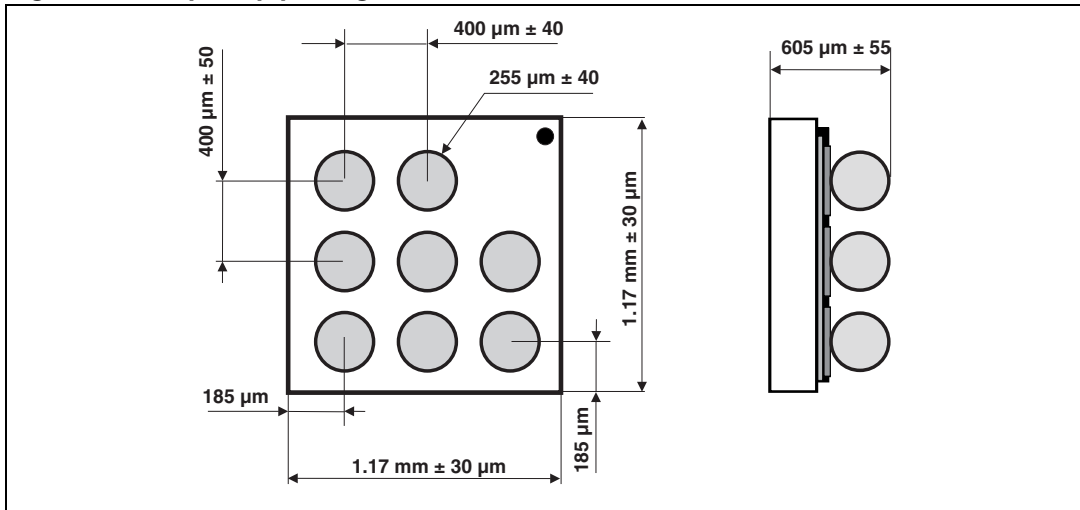

**Figure 12. Footprint recommendations**      **Figure 13. Marking**

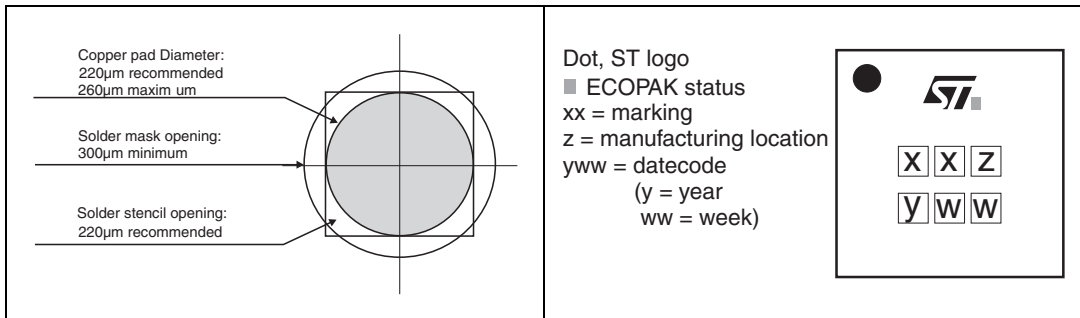
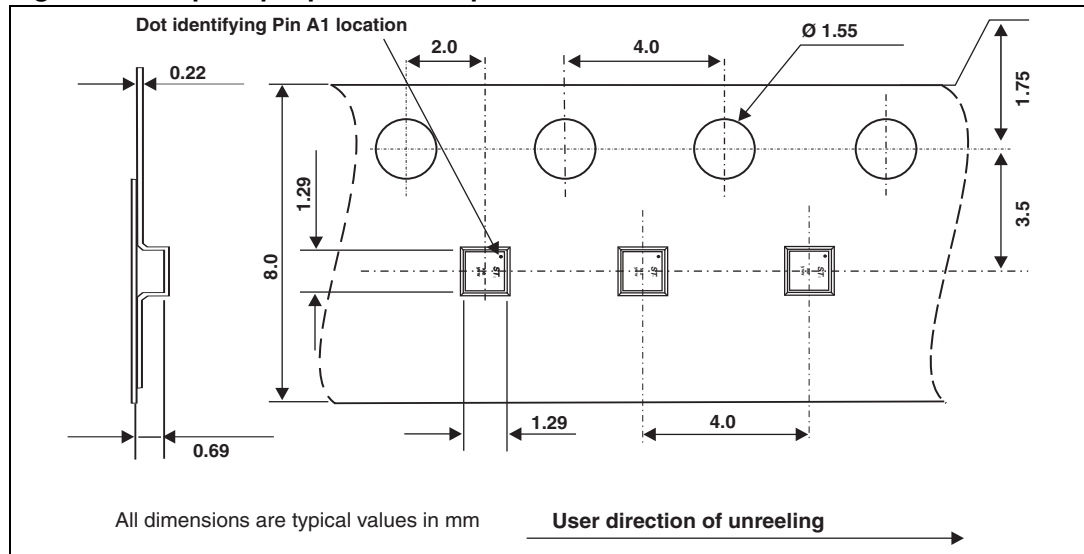

Figure 14. Flip-Chip tape and reel specification



## 4 Ordering information

Table 4. Ordering information

Order code	Marking	Package	Weight	Base qty	Delivery mode
EMIF02-MIC07F3	JE	Flip Chip	1.8 mg	5000	Tape and reel 7"

Note:

More information is available in the application notes

AN2348: "Flip Chip: Package description and recommendations for use"

AN1751: "EMI Filters: Recommendations and measurements"

## 5 Revision history

Table 5. Document revision history

Date	Revision	Changes
16-Mar-2010	1	Initial release.
12-Oct-2010	2	Added <a href="#">Table 3</a> .
23-Sep-2011	3	Added <a href="#">Acc_Det pin connection on page 2</a> .

**Please Read Carefully:**

Information in this document is provided solely in connection with ST products. STMicroelectronics NV and its subsidiaries ("ST") reserve the right to make changes, corrections, modifications or improvements, to this document, and the products and services described herein at any time, without notice.

All ST products are sold pursuant to ST's terms and conditions of sale.

Purchasers are solely responsible for the choice, selection and use of the ST products and services described herein, and ST assumes no liability whatsoever relating to the choice, selection or use of the ST products and services described herein.

No license, express or implied, by estoppel or otherwise, to any intellectual property rights is granted under this document. If any part of this document refers to any third party products or services it shall not be deemed a license grant by ST for the use of such third party products or services, or any intellectual property contained therein or considered as a warranty covering the use in any manner whatsoever of such third party products or services or any intellectual property contained therein.

**UNLESS OTHERWISE SET FORTH IN ST'S TERMS AND CONDITIONS OF SALE ST DISCLAIMS ANY EXPRESS OR IMPLIED WARRANTY WITH RESPECT TO THE USE AND/OR SALE OF ST PRODUCTS INCLUDING WITHOUT LIMITATION IMPLIED WARRANTIES OF MERCHANTABILITY, FITNESS FOR A PARTICULAR PURPOSE (AND THEIR EQUIVALENTS UNDER THE LAWS OF ANY JURISDICTION), OR INFRINGEMENT OF ANY PATENT, COPYRIGHT OR OTHER INTELLECTUAL PROPERTY RIGHT.**

**UNLESS EXPRESSLY APPROVED IN WRITING BY TWO AUTHORIZED ST REPRESENTATIVES, ST PRODUCTS ARE NOT RECOMMENDED, AUTHORIZED OR WARRANTED FOR USE IN MILITARY, AIR CRAFT, SPACE, LIFE SAVING, OR LIFE SUSTAINING APPLICATIONS, NOR IN PRODUCTS OR SYSTEMS WHERE FAILURE OR MALFUNCTION MAY RESULT IN PERSONAL INJURY, DEATH, OR SEVERE PROPERTY OR ENVIRONMENTAL DAMAGE. ST PRODUCTS WHICH ARE NOT SPECIFIED AS "AUTOMOTIVE GRADE" MAY ONLY BE USED IN AUTOMOTIVE APPLICATIONS AT USER'S OWN RISK.**

Resale of ST products with provisions different from the statements and/or technical features set forth in this document shall immediately void any warranty granted by ST for the ST product or service described herein and shall not create or extend in any manner whatsoever, any liability of ST.

ST and the ST logo are trademarks or registered trademarks of ST in various countries.

Information in this document supersedes and replaces all information previously supplied.

The ST logo is a registered trademark of STMicroelectronics. All other names are the property of their respective owners.

© 2011 STMicroelectronics - All rights reserved

STMicroelectronics group of companies

Australia - Belgium - Brazil - Canada - China - Czech Republic - Finland - France - Germany - Hong Kong - India - Israel - Italy - Japan - Malaysia - Malta - Morocco - Philippines - Singapore - Spain - Sweden - Switzerland - United Kingdom - United States of America

[www.st.com](http://www.st.com)