



■ Features :

- Universal AC input / Full range (up to 295VAC)
- Built-in active PFC function
- High efficiency up to 89%
- Protections: Short circuit / Over current / Over voltage / Over temperature
- Cooling by free air convection
- IP67 design for indoor or outdoor installations
- Class 2 power unit
- Pass LPS
- 100% full load burn-in test
- High reliability
- Suitable for LED lighting and moving sign applications (Note.2)
- Compliance to worldwide safety regulations for lighting
- Suitable for dry / damp / wet locations
- 3 years warranty



SPECIFICATION

MODEL	CLG-60-12	CLG-60-15	CLG-60-20	CLG-60-24	CLG-60-27	CLG-60-36	CLG-60-48	
OUTPUT	DC VOLTAGE	12V	15V	20V	24V	27V	36V	48V
	CONSTANT CURRENT REGION <small>Note.5</small>	8.4 ~ 12V	10.5 ~ 15V	14 ~ 20V	16.8 ~ 24V	18.9 ~ 27V	25.2 ~ 36V	33.6 ~ 48V
	RATED CURRENT	5A	4A	3A	2.5A	2.3A	1.7A	1.3A
	CURRENT RANGE	0 ~ 5A	0 ~ 4A	0 ~ 3A	0 ~ 2.5A	0 ~ 2.3A	0 ~ 1.7A	0 ~ 1.3A
	RATED POWER	60W	60W	60W	60W	62.1W	61.2W	62.4W
	RIPPLE & NOISE (max.) <small>Note.2</small>	2Vp-p	2.4Vp-p	1.8Vp-p	2.7Vp-p	2.7Vp-p	3.6Vp-p	4.6Vp-p
	VOLTAGE ADJ. RANGE	11.5 ~ 13V	14.5 ~ 16.2V	19.5 ~ 22V	24 ~ 26V	25 ~ 30V	32.5 ~ 39V	43.6 ~ 51.8V
		Fixed can be modified between the range above						
	CURRENT ADJ. RANGE	Fixed. Can be modified between 3% ~ -25% rated output current						
	VOLTAGE TOLERANCE <small>Note.3</small>	±10%						
LINE REGULATION	±3.0%							
LOAD REGULATION	±5.0%							
SETUP TIME	3000ms / 230VAC 5000ms / 115VAC at full load							
INPUT	VOLTAGE RANGE <small>Note.4</small>	90 ~ 295VAC		127 ~ 417VDC				
	FREQUENCY RANGE	47 ~ 63Hz						
	POWER FACTOR (Typ.)	PF>0.94/115VAC, PF>0.9/230VAC, PF>0.9/277VAC at full load (Please refer to "Power Factor Characteristic" curve)						
	EFFICIENCY (Typ.)	85%	86%	87.5%	87%	88%	89%	89%
	AC CURRENT (Typ.)	0.8A/115VAC		0.4A/230VAC		0.3A/277VAC		
	INRUSH CURRENT(max.)	40A/230VAC						
	LEAKAGE CURRENT	<0.75mA / 240VAC						
PROTECTION	OVER CURRENT	95 ~ 110%						
		Protection type : Constant current limiting, recovers automatically after fault condition is removed						
	SHORT CIRCUIT	Hiccup mode, recovers automatically after fault condition is removed						
	OVER VOLTAGE	13.8 ~ 16V	17.5 ~ 21V	23 ~ 28V	28 ~ 32V	31 ~ 35V	41 ~ 46V	54 ~ 60V
		Protection type : Shut down o/p voltage, re-power on to recover						
OVER TEMPERATURE	12V: 90°C ±10°C (TSW1) detect on heatsink of power transistor							
	15V ~ 48V: 85°C ±10°C (TSW1) detect on heatsink of power transistor							
	Protection type : Shut down o/p voltage, recovers automatically after temperature goes down							
ENVIRONMENT	WORKING TEMP.	-30 ~ +70°C (Refer to "Derating Curve")						
	WORKING HUMIDITY	20 ~ 95% RH non-condensing						
	STORAGE TEMP., HUMIDITY	-40 ~ +80°C, 10 ~ 95% RH						
	TEMP. COEFFICIENT	±0.03%/°C (0 ~ 50°C)						
	VIBRATION	10 ~ 500Hz, 5G 12min./1cycle, period for 72min. each along X, Y, Z axes						
SAFETY & EMC	SAFETY STANDARDS	UL879, UL8750, UL1310, TUV EN61347-1, EN61347-2-13 independent, CAN/CSA C22.2 No. 223-M91(except for 48V), CSA C22.2 No. 250.0-08(except for 48V), CSA C22.2 No. 207-M89(except for 48V), IP67, J61347-1, J61347-2-13(option) approved						
	WITHSTAND VOLTAGE	I/P-O/P:3.75KVAC I/P-FG:1.88KVAC O/P-FG:0.5KVAC						
	ISOLATION RESISTANCE	I/P-O/P:100M Ohms / 500VDC / 25°C / 70% RH						
	EMC EMISSION	Compliance to EN55015, EN55022 (CISPR22) Class B, EN61000-3-2 Class C (≥ 75% load) ; EN61000-3-3						
	EMC IMMUNITY	Compliance to EN61000-4-2,3,4,5,6,8,11, EN55024, EN61547, light industry level (surge 4KV), criteria A						
OTHERS	MTBF	495.7K hrs min. MIL-HDBK-217F (25°C)						
	DIMENSION	195.6*61.5*38.8mm (L*W*H)						
	PACKING	0.86Kg; 16pcs/14.8Kg/0.54CUFT						
NOTE	<ol style="list-style-type: none"> 1. All parameters NOT specially mentioned are measured at 230VAC input, rated load and 25°C of ambient temperature. 2. Ripple & noise are measured at 20MHz of bandwidth by using a 12" twisted pair-wire terminated with a 0.1uf & 47uf parallel capacitor. 3. Tolerance : includes set up tolerance, line regulation and load regulation. 4. Derating may be needed under low input voltage. Please check the static characteristics for more details. 5. Constant current operation region is within 70% ~100% rated output voltage. This is the suitable operation region for LED related applications, but please reconfirm special electrical requirements for some specific system design. 6. The power supply is considered as a component that will be operated in combination with final equipment. Since EMC performance will be affected by the complete installation, the final equipment manufacturers must re-qualify EMC Directive on the complete installation again. 7. Direct connecting to LEDs is suggested, but is not suitable for using additional drivers. 							

Mechanical Specification

Case No. 957A Unit:mm

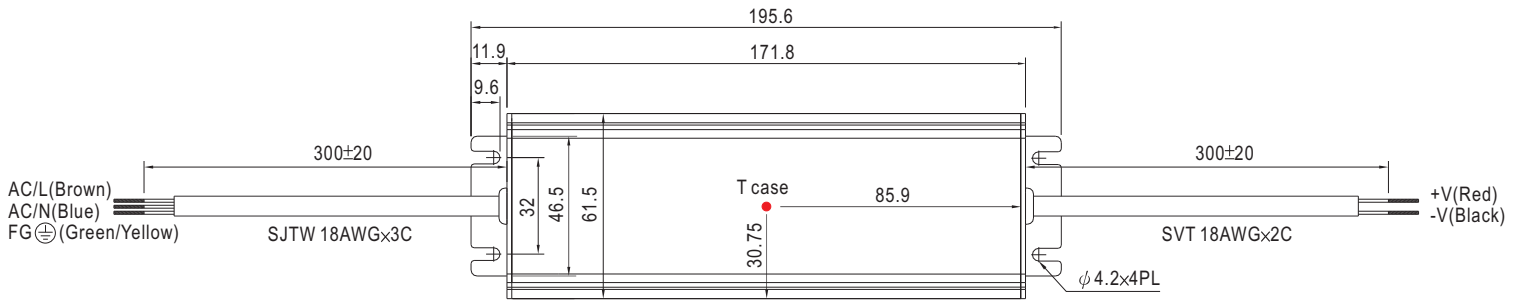

※ T case: Max. Case Temperature.



Block Diagram

fosc : 90KHz(115VAC)
120KHz(230VAC)

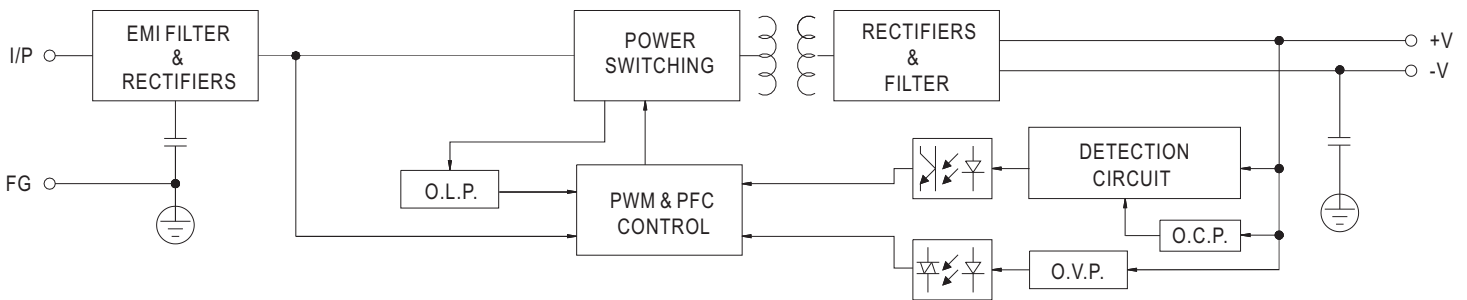

Derating Curve

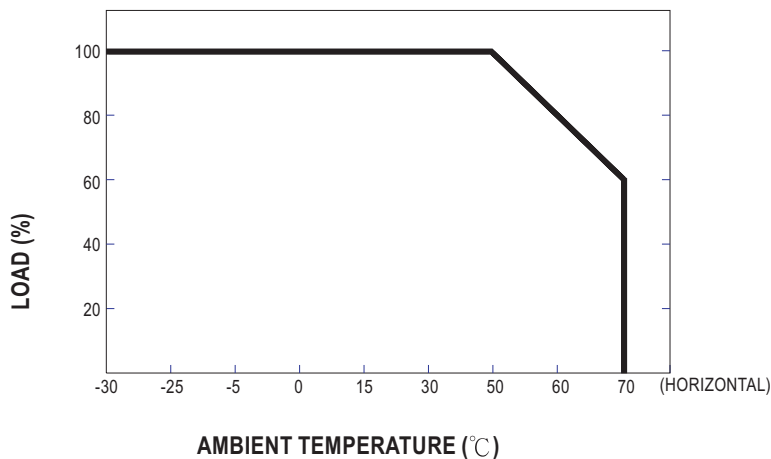

Static Characteristics

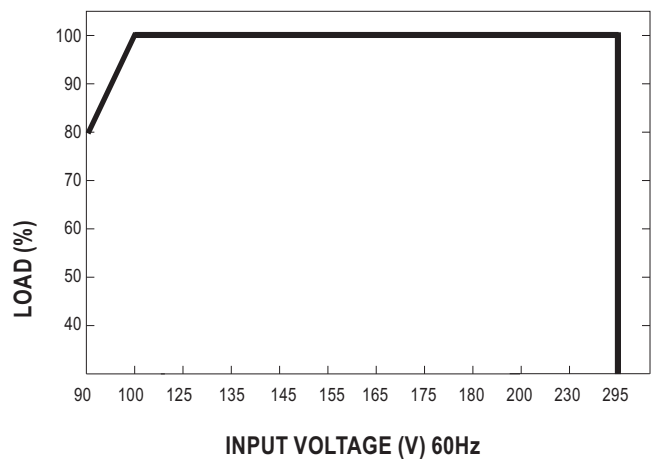

Power Factor Characteristic

Constant Current Mode

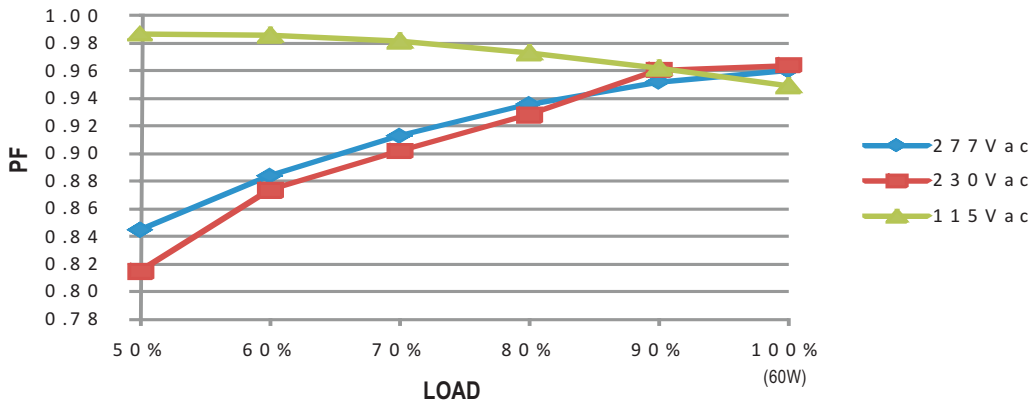

EFFICIENCY vs LOAD (48V Model)

CLG-60 series possess superior working efficiency that up to 89% can be reached in field applications.

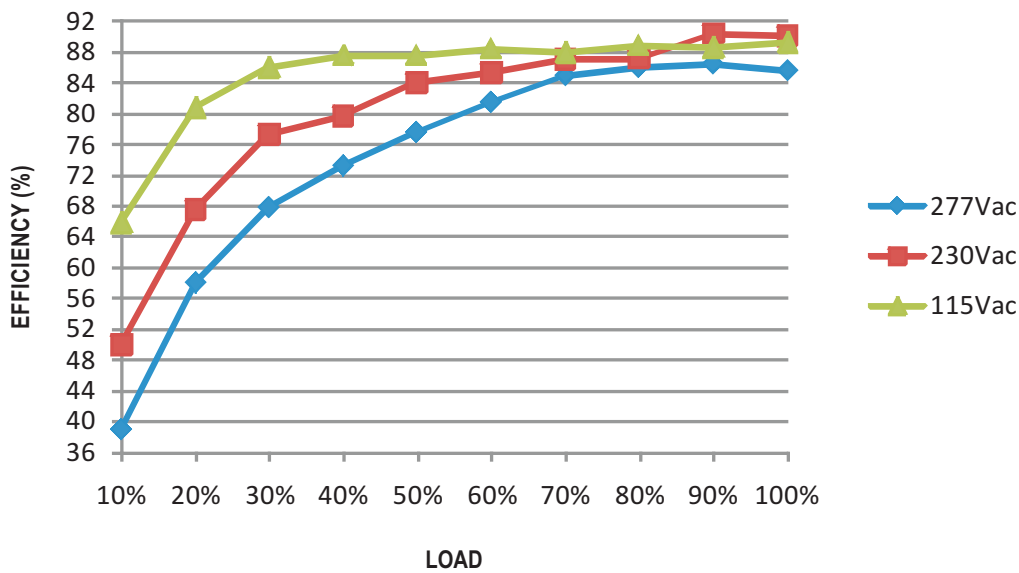

DRIVING METHODS OF LED MODULE

This LED power supply is suggested to work in constant current mode area (CC) to drive the LEDs.

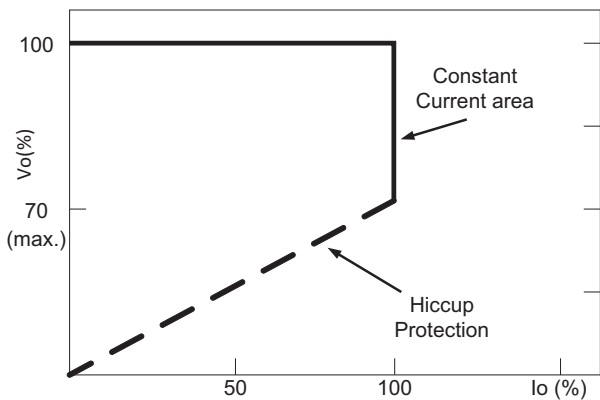

Typical LED power supply I-V curve