

49 WLED Driver with Boost Converter

FEATURES

- High efficiency boost converter with the input voltage range from 2.7 to 5.5 V
- No external Schottky Required (Internal synchronous rectifier*)
- 250 mV current sense voltage
- Drives up to 7 LEDs per string with up to 49 LED in 7 strings at 25 mA
- 1 MHz Switching Frequency
- Efficiency greater than 83%
- PWM LED Dimming Control Mode
- Over-voltage, under-voltage, over-current, and over-temperature protection
- Low Shutdown Current (<1 μ A)
- Available in 2 x 3 x 0.8 mm 8-pin TDFN package

APPLICATION

- Color Display Backlight
- Portable Navigation and GPS Receivers
- Smart phones
- Digital Photo Frames
- Portable DVD Players, Notebooks

DESCRIPTION

The LDS8726 is a fixed frequency current mode boost converter with internal synchronous rectifier and cycle-by-cycle switch current limit specifically designed to drive matrix of LEDs in respect with the Table 1. Operation at 1 MHz allows use of small value low profile inductor (10 – 33 μ H) and 1 μ F 50 V ceramic capacitor.

The use of integrated synchronous rectifier makes the efficiency dependent on only inductor DC

TYPICAL APPLICATION CIRCUIT

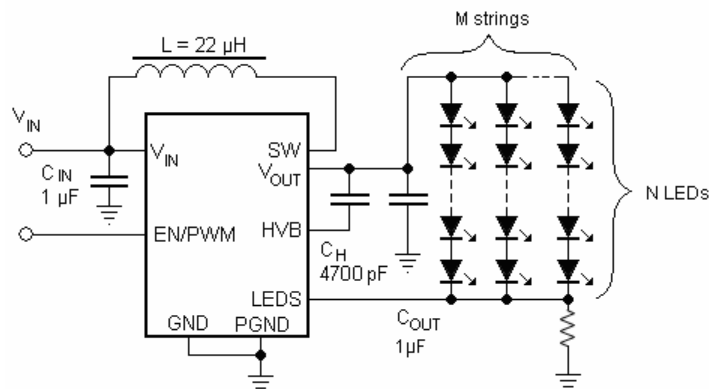

*) Patent pending

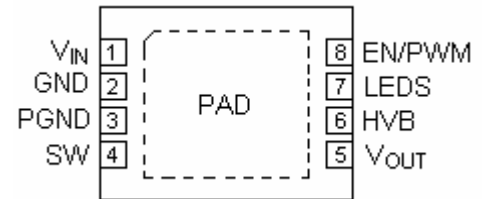

resistance. Under-voltage protection disables the part when V_{IN} voltage reaches 2.0 V

The LDS8726 has thermal shutdown set at 150 $^{\circ}$ C. Above this value, the boost converter stops switching. The part resumes normal operations when temperature drops below 130 $^{\circ}$ C.

The over-current protection provides cycle-by-cycle current limit.

The internal output over-voltage protection prevents damage in the case of a faulty LED disconnect.

The PWM control ensures brightness adjustment with a frequency from 100 Hz up to 30 KHz.

The EN/PWM logic input functions as a chip enable and LED current PWM control pin.

The device is available in 8-pin TDFN 2 x 3 mm package with a max height of 0.8 mm.

Table 1 Matrix configuration for LDS8726

Number of strings	Number of LED per string	String Current max, mA,	$V_{IN \text{ MIN}}$, V
1 - 5	7	30	2.7
6	7	30	3.3
6	7	25	2.7
7	7	25	3.1
7	6	25	2.7
8	5	25	2.7

ABSOLUTE MAXIMUM RATINGS

Parameter	Rating	Unit
V _{IN} voltage	6	V
V _{OUT} , SW, LEDS, V _{HVB} voltage	40	V
EN/SET voltage	V _{IN} + 0.7V	V
Storage Temperature Range	-65 to +160	°C
Junction Temperature Range	-40 to +125	°C
8-pin TDFN package Thermal Resistance	65	°C/W
Soldering Temperature	300	°C

RECOMMENDED OPERATING CONDITIONS

Parameter	Rating	Unit
V _{IN}	2.7 to 5.5	V
Ambient Temperature Range	-40 to +85	°C

Typical application circuit with external components is shown on page 1.

ELECTRICAL OPERATING CHARACTERISTICS

(Over recommended operating conditions unless specified otherwise) V_{IN} = 3.6V, T_{AMB} = 25°C, C_{IN} = 1 μF, C_{OUT} = 1 μF, L = 22 μH

Name	Conditions	Min	Typ	Max	Units
Quiescent Current	V _{IN} = 3.6 V, V _{OUT} open		1		mA
	V _{IN} = 3.6 V, I _{LED} = 25 mA @ V _{OUT} = 36 V		3		
Shutdown Current	V _{IN} = 5.5V, EN = 0V			1	μA
LED Current Accuracy	At factory preset value		±3		%
Oscillator Frequency			1.0		MHz
Maximum Duty Cycle			92		%
NMOSFET Switch On Resistance			0.3		Ω
PMOSFET Switch On Resistance			1.5		Ω
Switch Leakage Current				0.1	μA
Switch Current Limit			1.9		A
Dropout/Current sense voltage	At factory preset value		250		mV
PWM Frequency		0.1		30	kHz
EN/PWM Pin	Input Resistance (pull down)		250		kΩ
	Logic Level	High	1.4		V
		Low			
Thermal Shutdown			150		°C
Thermal Hysteresis			20		
Over-Voltage Protection			26		V
Soft Start Time			1.5		ms
Delay Time to Shutdown	EN = 0		10		ms

TYPICAL CHARACTERISTICS

$V_{in} = 3.6V$, $I_{OUT} = 30mA$ (1 string with 7 LEDs, $C_{IN} = 1\mu F$, $C_{OUT} = 1\mu F$, $L = 22\mu H$, $T_{AMB} = 25^{\circ}C$ unless otherwise specified)

Power Efficiency vs. Input Voltage

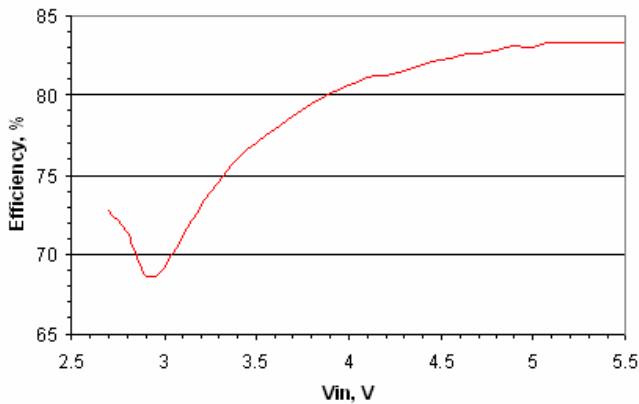

LED Current vs. Input Voltage

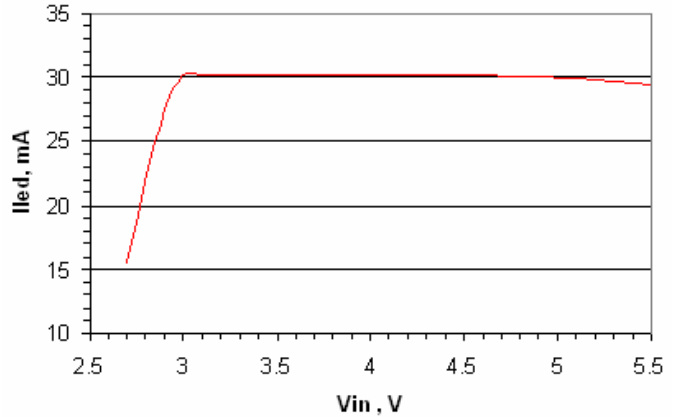

LED Current vs. PWM Duty Cycle

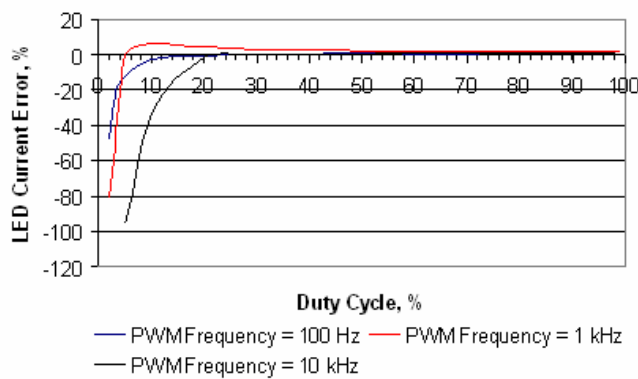

LED Current Error vs. PWM Frequency

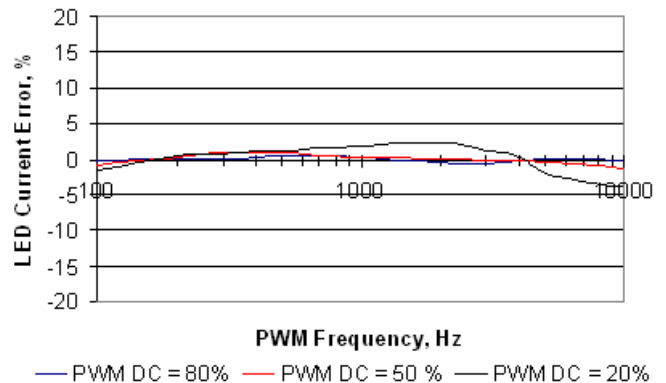

Soft Start Waveforms

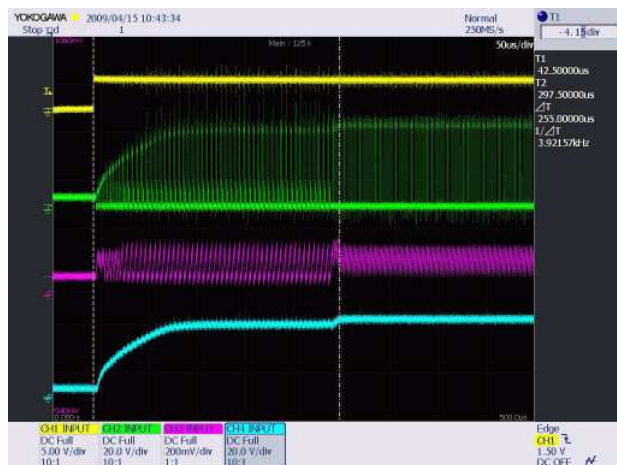

Ch 1 (yellow) – EN pin, Ch 2 (green) – SW node voltage
 Ch 3 (red) – Inductor current, Ch 4 (blue) – V_{OUT}

Operating Waveforms

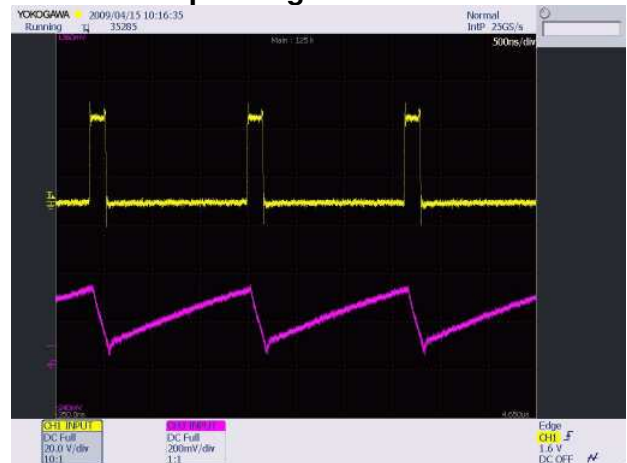

Ch 1 (yellow) – SW node voltage,
 Ch 3 (red) – Inductor current

TYPICAL CHARACTERISTICS

$V_{in} = 3.6V$, $I_{OUT} = 30mA$ (1 string with 7 LEDs, $C_{IN} = 1\mu F$, $C_{OUT} = 1\mu F$, $L = 22\mu H$, $T_{AMB} = 25^{\circ}C$ unless otherwise specified)

Waveforms at PWM LED Current Regulation



Ch 1 (yellow) – PWM signal at 1 kHz 5% duty cycle
 Ch 2 (green) – SW node voltage, Ch 3 (red) – LED Current.
 Ch 4 (blue) - V_{OUT}

Waveforms at PWM LED Current Regulation

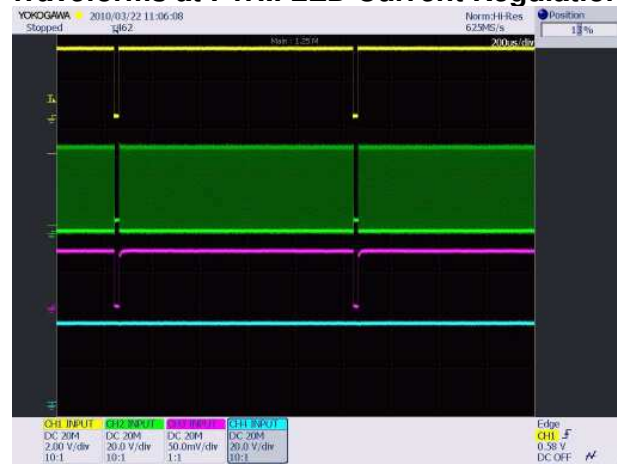

Ch 1 (yellow) – PWM signal at 1 kHz 98% duty cycle
 Ch 2 (green) – SW node voltage, Ch 3 (red) – LED Current.
 Ch 4 (blue) - V_{OUT}

Waveforms at PWM LED Current Regulation

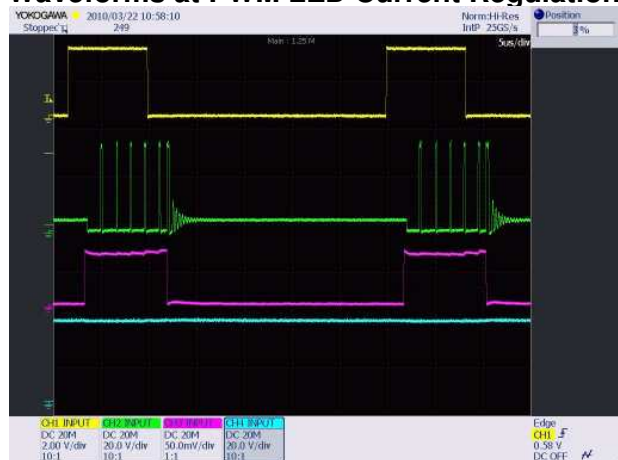

Ch 1 (yellow) – PWM signal at 30 kHz 25% duty cycle
 Ch 2 (green) – SW node voltage, Ch 3 (red) – LED Current.
 Ch 4 (blue) - V_{OUT}

Waveforms at PWM LED Current Regulation

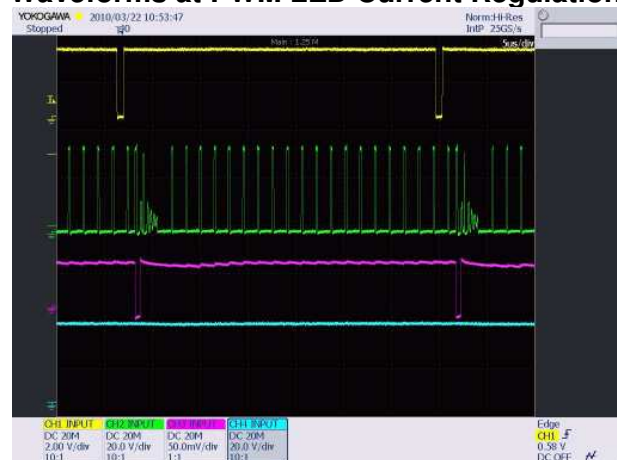

Ch 1 (yellow) – PWM signal at 30 kHz 98% duty cycle
 Ch 2 (green) – SW node voltage, Ch 3 (red) – LED Current.
 Ch 4 (blue) - V_{OUT}

PIN DESCRIPTION

Pin #	Name	Function
1	V _{IN}	Input Voltage, connect to battery or power supply
2	GND	Analog Ground
3	PGND	Power Ground
4	SW	Switch input; Connect inductor terminal to this pin
5	V _{OUT}	Output voltage; Connect the LED string anode terminal to this pin.
6	HVB	High Voltage Bypass; Connect a 470 pF capacitor between this point and V _{OUT}
7	LEDS	Current Sense input. Connect LED string cathode terminal to this pin
8	EN/PWM	Device Enable (active high) and Dimming Control
PAD	PAD	Connect to GND on the PCB

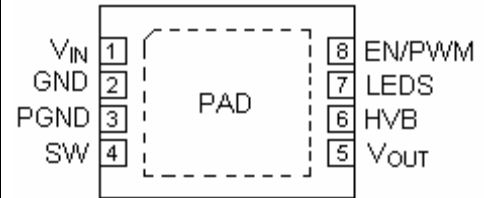

Top view: TDFN 8-lead 2 X 3 mm

PIN FUNCTION

V_{IN} is the supply pin for the driver. A small 1 μ F ceramic bypass capacitor is required between the V_{IN} pin and ground near the device. The operating input voltage range is from 2.7 V to 5.5 V. If the input supply voltage falls below the under-voltage threshold, switch is disabled, and the device enters shutdown mode.

HVB is the internal high voltage reference point. Connect a 4700 pF capacitor between this point and V_{OUT}.

EN/PWM is the enable and PWM control logic input. Guaranteed levels of logic high and logic low are set at 1.4 V and 0.4 V respectively. When EN/PWM is initially taken high, the device becomes enabled and LED current sets to maximum programmed value.. To place the device into shutdown mode, the EN/PWM pin must be held low for more than 10 ms.

V_{OUT} is the driver output. Connect it to the LED anode. A ceramic bypass capacitor of 1 μ F requires between the V_{OUT} pin and ground near the device.

GND is the ground reference for the analog circuits. The pin must be connected to the ground plane on the PCB. Avoid high currents flowing trough traces connecting this pin with EN/PWM signal source.

PGND is the current return for high current circuits. The pin must be connected to the ground plane on the PCB. Connect GND and PGND as close to the driver as possible.

LEDS is the Current Sense pin that provides internal regulated current sink for LED string. Connect LED string cathode to this pin. This pin enter high-impedance zero current state whenever the device is in shutdown mode.

PAD is the exposed pad underneath the package. For best thermal performance, the pad should be soldered to the PCB and connected to the ground plane

BLOCK DIAGRAM

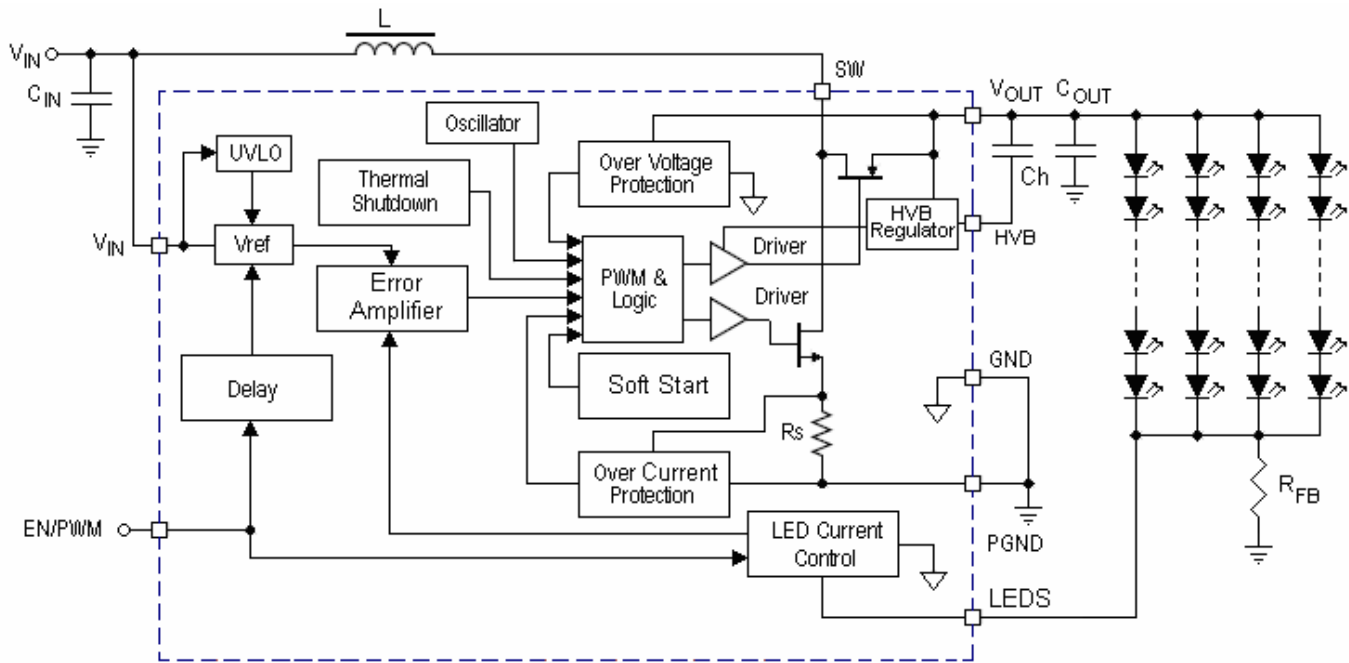

Figure 2. LDS8726 Functional Block Diagram

BASIC OPERATION

At power-up, EN/PWM pin should be logic LOW. The LDS8726 starts operating when EN/PWM pin is asserted logic high. If the input voltage is sufficient to regulate all LED currents, the device remains in operating mode. The low dropout Current regulator performs well at V_{OUT} voltage up to 250 mV above summary LED forward voltage significantly increasing driver's efficiency.

If the input voltage is insufficient or falls to a level where the regulated currents cannot be maintained, the Under-Voltage protection turns device off setting it in shutdown mode.

The LDS8726 has soft start function that prevent high input current spike at device' wake-up.

The EN/PWM pin should be held low for more than 10 ms to completely turn device in low current shutdown mode.

LED Current Setting

The maximum current sink value in the LEDS pin is factory preset at 30 mA. An external resistor R_{FB} should be used to bypass current if more than one string is connected. $R_{FB} = 0.25 V / (I \times M - 0.03)$, ohms, where 0.25 V is a feedback voltage, I – is current value per string in amperes, and M is number of strings connected in parallel.

Power dissipated at R_{FB} is equal $W = 0.0625/R_{FB}$, watt.

In case of three strings with 25 mA current per string $R_{FB} = 0.25 / (0.025 \times 3 - 0.03) = 5.6 \Omega$, and dissipated power $W = 0.0625 / 5.6 = 0.011 W$.

The average LED string current that determines LED brightness may be controlled applying PWM signal to the EN/PWM pin. The maximum PWM frequency is 30 kHz, while frequencies below 100 Hz are not recommended to avoid visible LED flickering. Duty cycle that determines average LED string current may vary in the range from 5% to 100% at 1 kHz or from 20% to 100% at 30 kHz with high linearity current regulation.

Protection Mode

The output voltage V_{OUT} is limited at about 36 V. This is to prevent the output pin from exceeding its absolute maximum rating if LED string is disconnected or any LED in string burns out creating open circuitry.

If the die temperature exceeds +150°C, the driver will enter a thermal protection shutdown mode. When the device temperature drops by about 20°C, the device will resume normal operation.

If the input supply voltage falls below the under-voltage threshold, switch is disabled, and the device enters shutdown mode.

LED Selection

The number of the LEDs in string is limited by maximum output voltage that cannot exceed over-voltage protection level. We recommend using not more than 10 LEDs with $V_F \leq 3.6$ V in string if V_{IN} voltage is above 3.0 V and not more than 8 LEDs if V_{IN} may fall up to 2.7 V.

External Components Selection

The LDS8726 requires four external components only. The recommended input capacitor value is between 1.0 and 10uF, while the output capacitor selection is function of desired output ripple, loop stability, and inrush current. We recommend $C_{OUT} = 1 \mu\text{F}$.

The inductor should allow around 20% higher peak current than LDS8726 Switch Current Limit I_{LIM} (see table *Electrical Operating Characteristics* on page 2).

However, the maximum ripple current through inductor I_R should not exceed

$$I_R = 2 \left(I_{LIM} - \frac{I_{LED} (NV_F + V_d)}{V_{IN} \eta} \right), \text{ where}$$

V_F - is a LED forward voltage, V

N - is number of LEDs per string

V_d - is a current regulator voltage drop = 0.2 V,

V_{IN} - is an input voltage, V

We recommend continuous conduction mode for inductor to achieve highest efficiency. That limits I_R value as

$$I_R < \frac{2I_{LED} (NV_F + V_d)}{\eta V_{IN}}$$

Inductor value L is a function of switching frequency, input and output voltage and is determined by following equation:

$$L = \frac{1}{I_R f \left(\frac{1}{NV_F + V_d + V_{PM} - V_{IN}} + \frac{1}{V_{IN}} \right)}, \text{ where}$$

V_{PM} - is a voltage drop across synchronous rectifier (PMOSFET) = 1.5 ohms x I_{LED} , (A),

L - is an inductance, H, and
 f - is a switching frequency, 700 kHz.

Inductor should have minimum DC resistance to avoid driver's efficiency degradation.

The equation for the output capacitor selection is:

$$C_{OUT} = \frac{(NV_F + V_d - V_{IN}) I_{OUT}}{(NV_F + V_d) V_R f}, \text{ where}$$

V_R - is a ripple voltage at the output.

For example:

If $V_{IN} = 2.7$ V, $N = 7$, $V_F = 3.3$ V, $V_d = 0.25$ V, $f = 1$ MHz, $I_{OUT} = 90$ mA, (3 strings in parallel x 30 mA) and ripple voltage $V_R = 0.1$ V, $C_{OUT} = 0.63 \mu\text{F}$ so $1 \mu\text{F}$ is a good choice.

We recommend $C_{OUT} = 1 \mu\text{F}$ to achieve better efficiency and driver's stability.

Recommended Layout

In active mode, the driver switches internally at a high frequency. We recommend minimize trace length to all external capacitors and inductor. The input and output ceramic capacitors (X5R or X7R type) should located as close to the device' pins as possible to prevent from EMI distribution

A ground plane should cover the area under the driver IC as well as the bypass capacitors. Short connection to ground on capacitors C_{IN} and C_{OUT} can be implemented with the use of multiple via. A copper area matching the TDFN exposed pad (PAD) must be connected to the ground plane underneath. The use of multiple via improves the package heat dissipation.

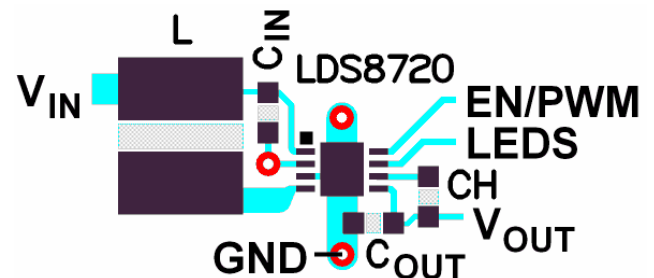
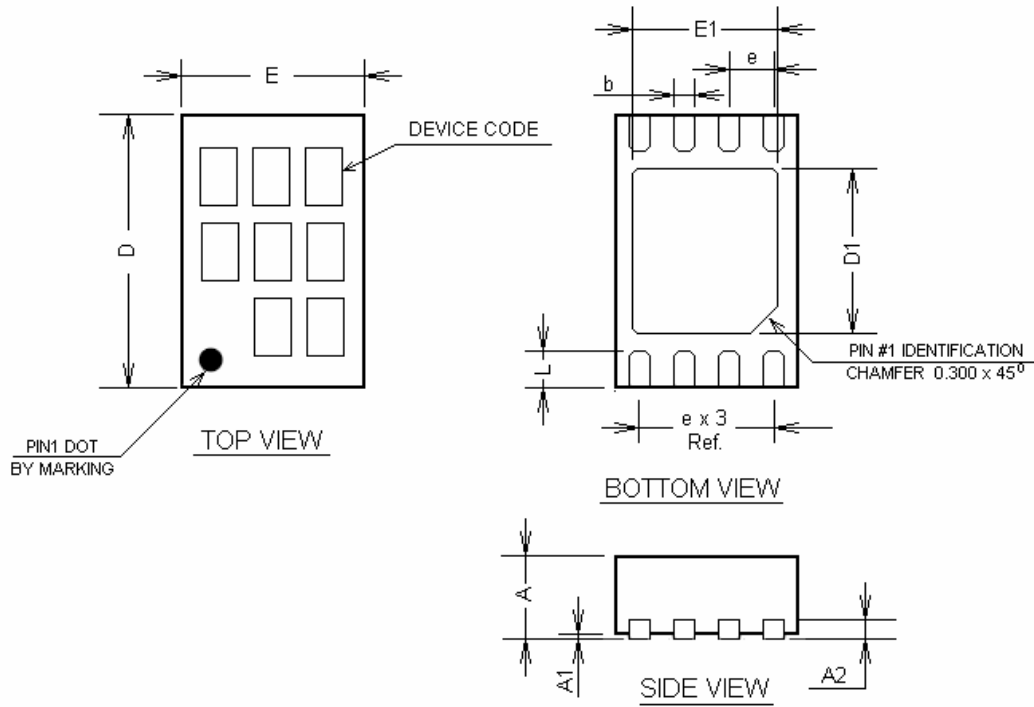

Figure 3. Recommended layout

PACKAGE DRAWING AND DIMENSIONS

8-PIN TDFN, 2mm x 3mm, 0.5mm PITCH



SYMBOL	MIN	NOM	MAX
A	0.700	0.750	0.800
A1	-	0.000	0.050
A2		0.203 Ref.	
b	0.180	0.230	0.280
D	2.950	3.000	3.050
D1	1.750	1.800	1.850
E	1.950	2.000	2.050
E1	1.550	1.600	1.650
e		0.500 Bsc	
L	0.350	0.400	0.450

Note:

1. All dimensions are in millimeters
2. Complies with JEDEC Standard MO-220

Warranty and Use

IXYS CORP. MAKES NO WARRANTY, REPRESENTATION OR GUARANTEE, EXPRESS OR IMPLIED, REGARDING THE SUITABILITY OF ITS PRODUCTS FOR ANY PARTICULAR PURPOSE, NOR THAT THE USE OF ITS PRODUCTS WILL NOT INFRINGE ITS INTELLECTUAL PROPERTY RIGHTS OR THE RIGHTS OF THIRD PARTIES WITH RESPECT TO ANY PARTICULAR USE OR APPLICATION AND SPECIFICALLY DISCLAIMS ANY AND ALL LIABILITY ARISING OUT OF ANY SUCH USE OR APPLICATION, INCLUDING BUT NOT LIMITED TO, CONSEQUENTIAL OR INCIDENTAL DAMAGES.

IXYS Corp. products are not designed, intended, or authorized for use as components in systems intended for surgical implant into the body, or other applications intended to support or sustain life, or for any other application in which the failure of the IXYS Corp. product could create a situation where personal injury or death may occur.

IXYS Corp. reserves the right to make changes to or discontinue any product or service described herein without notice. Products with data sheets labeled "Advance Information" or "Preliminary" and other products described herein may not be in production or offered for sale.

IXYS Corp. advises customers to obtain the current version of the relevant product information before placing orders. Circuit diagrams illustrate typical semiconductor applications and may not be complete.



IXYS Corp.
1590 Buckeye Dr.,
Milpitas, CA 95035-7418
Phone: 408.457.9000
Fax: 408.496.0222
<http://www.ixys.com>

Document No: 8726DS
Revision: N1.0
Issue date: 2/8/2011