

# Thyristor Modules

## Thyristor/Diode Modules

$$I_{TRMS} = 2 \times 400 \text{ A}$$

$$I_{TAVM} = 2 \times 250 \text{ A}$$

$$V_{RRM} = 800-1800 \text{ V}$$

$V_{RSM}$ $V_{DSM}$ V	$V_{RRM}$ $V_{DRM}$ V	Type	Version 1	Version 1
900	800	MCC 220-08io1	MCC 220-08io1	MCD 220-08io1
1300	1200	MCC 220-12io1	MCC 220-12io1	MCD 220-12io1
1500	1400	MCC 220-14io1	MCC 220-14io1	MCD 220-14io1
1700	1600	MCC 220-16io1	MCC 220-16io1	MCD 220-16io1
1900	1800	MCC 220-18io1	MCC 220-18io1	MCD 220-18io1

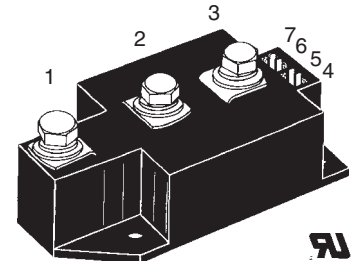

Symbol	Conditions	Maximum Ratings	
$I_{TRMS}, I_{FRMS}$ $I_{TAVM}, I_{FAVM}$	$T_{VJ} = T_{VJM}$ $T_C = 85^\circ\text{C}; 180^\circ \text{ sine}$	400	A
		250	A
$I_{TSM}, I_{FSM}$	$T_{VJ} = 45^\circ\text{C}$ $V_R = 0$	$t = 10 \text{ ms (50 Hz), sine}$ $t = 8.3 \text{ ms (60 Hz), sine}$	8500 9000 A A
	$T_{VJ} = T_{VJM}$ $V_R = 0$	$t = 10 \text{ ms (50 Hz), sine}$ $t = 8.3 \text{ ms (60 Hz), sine}$	7000 7600 A A
$\int i^2 dt$	$T_{VJ} = 45^\circ\text{C}$ $V_R = 0$	$t = 10 \text{ ms (50 Hz), sine}$ $t = 8.3 \text{ ms (60 Hz), sine}$	360000 336000 $\text{A}^2\text{s}$ $\text{A}^2\text{s}$
	$T_{VJ} = T_{VJM}$ $V_R = 0$	$t = 10 \text{ ms (50 Hz), sine}$ $t = 8.3 \text{ ms (60 Hz), sine}$	245000 240000 $\text{A}^2\text{s}$ $\text{A}^2\text{s}$
$(di/dt)_{cr}$	$T_{VJ} = T_{VJM};$ $f = 50 \text{ Hz}; t_p = 200 \mu\text{s}$ $V_D = \frac{2}{3} V_{DRM}$	repetitive, $I_T = 750 \text{ A}$	100 $\text{A}/\mu\text{s}$
	$I_G = 1 \text{ A}$ $di_G/dt = 1 \text{ A}/\mu\text{s}$	non repetitive, $I_T = 250 \text{ A}$	800 $\text{A}/\mu\text{s}$
$(dv/dt)_{cr}$	$T_{VJ} = T_{VJM};$ $R_{GK} = \infty; \text{method 1 (linear voltage rise)}$	$V_{DR} = \frac{2}{3} V_{DRM}$	1000 $\text{V}/\mu\text{s}$
$P_{GM}$	$T_{VJ} = T_{VJM};$ $I_T = I_{TAVM};$	$t_p = 30 \mu\text{s}$ $t_p = 500 \mu\text{s}$	120 60 W W
$P_{GAV}$			20 W
$V_{RGM}$			10 V
$T_{VJ}$			-40...+140 $^\circ\text{C}$
$T_{VJM}$			140 $^\circ\text{C}$
$T_{stg}$			-40...+125 $^\circ\text{C}$
$V_{ISOL}$	50/60 Hz, RMS; $I_{ISOL} \leq 1 \text{ mA};$	$t = 1 \text{ min}$ $t = 1 \text{ s}$	3000 3600 V~ V~
$M_d$	Mounting torque (M5) Terminal connection torque (M8)		2.5-5/22-44 12-15/106-132 $\text{Nm}/\text{lb.in.}$ $\text{Nm}/\text{lb.in.}$
<b>Weight</b>	Typical including screws		320 g

Data according to IEC 60747 and refer to a single thyristor/diode unless otherwise stated.  
IXYS reserves the right to change limits, test conditions and dimensions

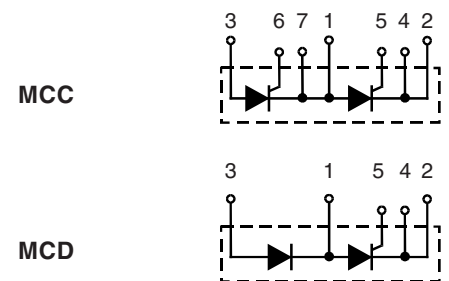

### Features

- International standard package
- Direct copper bonded  $\text{Al}_2\text{O}_3$ -ceramic base plate
- Planar passivated chips
- Isolation voltage 3600 V~
- UL registered, E 72873
- Keyed gate/cathode twin pins

### Applications

- Motor control
- Power converter
- Heat and temperature control for industrial furnaces and chemical processes
- Lighting control
- Contactless switches

### Advantages

- Space and weight savings
- Simple mounting
- Improved temperature and power cycling
- Reduced protection circuits

Symbol	Conditions	Characteristic Values
$I_{RRM}$	$T_{VJ} = T_{VJM}; V_R = V_{RRM}; V_D = V_{DRM}$	70 mA
$I_{DRM}$		40 mA
$V_T, V_F$	$I_T/I_F = 600 \text{ A}; T_{VJ} = 25^\circ\text{C}$	1.53 V
$V_{T0}$	For power-loss calculations only ( $T_{VJ} = 140^\circ\text{C}$ )	0.9 V
$r_T$		1.0 mΩ
$V_{GT}$	$V_D = 6 \text{ V}; T_{VJ} = 25^\circ\text{C}$	2 V
	$T_{VJ} = -40^\circ\text{C}$	3 V
$I_{GT}$	$V_D = 6 \text{ V}; T_{VJ} = 25^\circ\text{C}$	150 mA
	$T_{VJ} = -40^\circ\text{C}$	200 mA
$V_{GD}$	$T_{VJ} = T_{VJM}; V_D = \frac{2}{3} V_{DRM}$	0.25 V
$I_{GD}$		10 mA
$I_L$	$T_{VJ} = 25^\circ\text{C}; t_p = 30 \mu\text{s}; V_D = 6 \text{ V}$ $I_G = 0.45 \text{ A}; di_G/dt = 0.45 \text{ A}/\mu\text{s}$	200 mA
$I_H$	$T_{VJ} = 25^\circ\text{C}; V_D = 6 \text{ V}; R_{GK} = \infty$	150 mA
$t_{gd}$	$T_{VJ} = 25^\circ\text{C}; V_D = \frac{1}{2} V_{DRM}$ $I_G = 1 \text{ A}; di_G/dt = 1 \text{ A}/\mu\text{s}$	2 μs
$t_q$	$T_{VJ} = T_{VJM}; I_T = 300 \text{ A}, t_p = 200 \mu\text{s}; -di/dt = 10 \text{ A}/\mu\text{s}$ $V_R = 100 \text{ V}; dv/dt = 50 \text{ V}/\mu\text{s}; V_D = \frac{2}{3} V_{DRM}$	typ. 200 μs
$Q_S$	$T_{VJ} = 125^\circ\text{C}; I_T, I_F = 400 \text{ A}, -di/dt = 50 \text{ A}/\mu\text{s}$	760 μC
$I_{RM}$		275 A
$R_{thJC}$	per thyristor/diode; DC current per module	0.139 KW
$R_{thJK}$	per thyristor/diode; DC current per module	0.0695 KW
	other values see Fig. 8/9	0.179 KW
		0.0895 KW
$d_s$	Creepage distance on surface	12.7 mm
$d_A$	Strike distance through air	9.6 mm
$a$	Maximum allowable acceleration	50 m/s <sup>2</sup>

Optional accessories for modules

Keyed gate/cathode twin plugs with wire length = 350 mm, gate = yellow, cathode = red  
 Type **ZY 180L** (L = Left for pin pair 4/5) } UL 758, style 1385,  
 Type **ZY 180R** (R = right for pin pair 6/7) } CSA class 5851, guide 460-1-1

Dimensions in mm (1 mm = 0.0394")

**MCC**

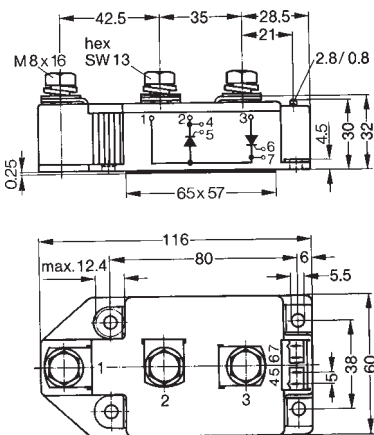

**MCD**

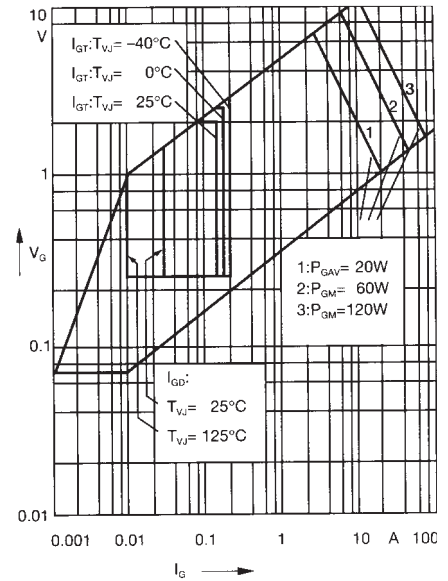
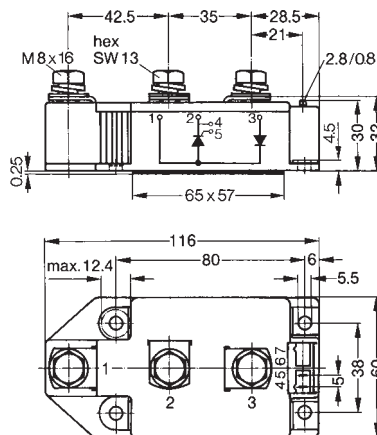

Fig. 1 Gate trigger characteristics

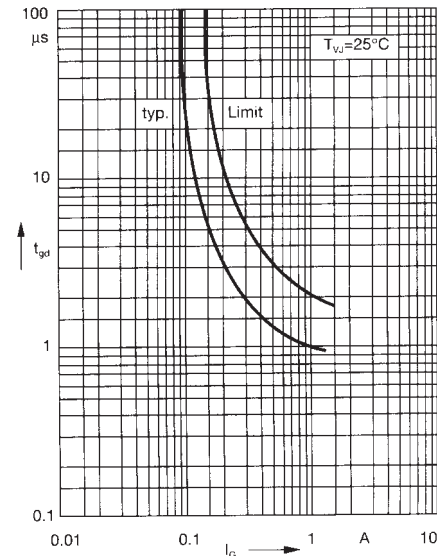
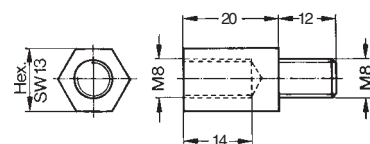

Fig. 2 Gate trigger delay time

Threaded spacer for higher Anode/Cathode construction:  
 Type **ZY 250**, material brass



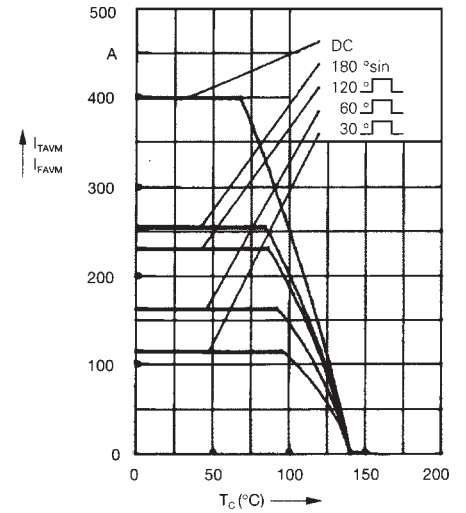
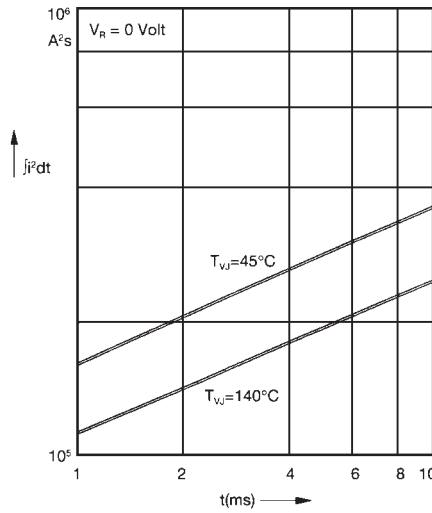
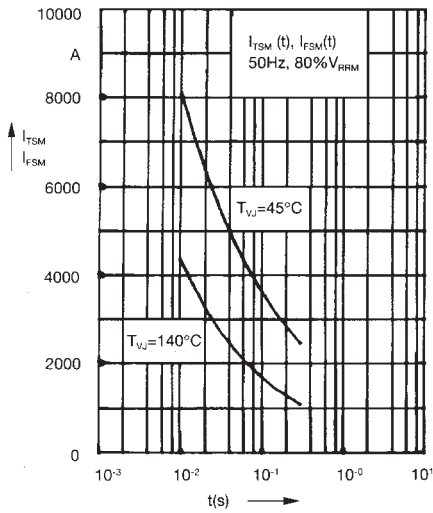

Fig. 3 Surge overload current  
 $I_{TSM}, I_{FSM}$ : Crest value,  $t$ : duration

Fig. 4  $\int i^2 dt$  versus time (1-10 ms)

Fig. 4a Maximum forward current at case temperature

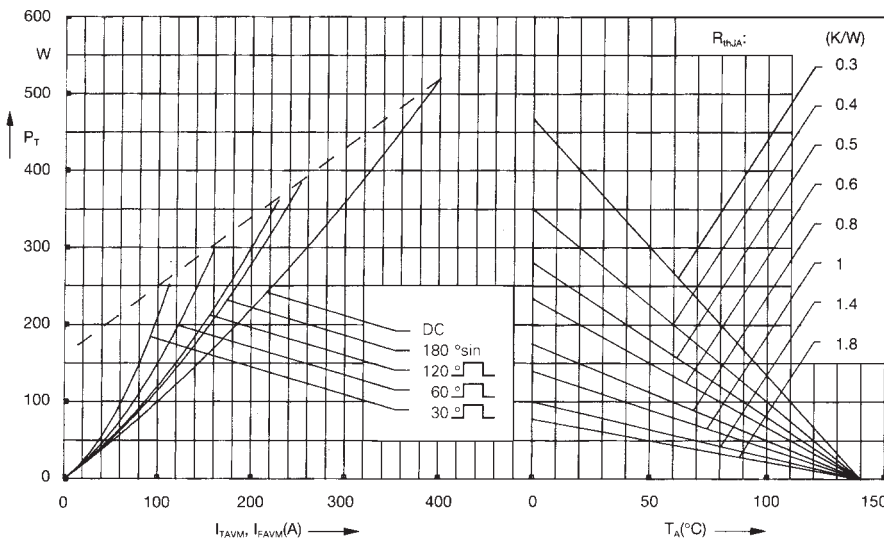

Fig. 5 Power dissipation versus on-state current and ambient temperature (per thyristor or diode)

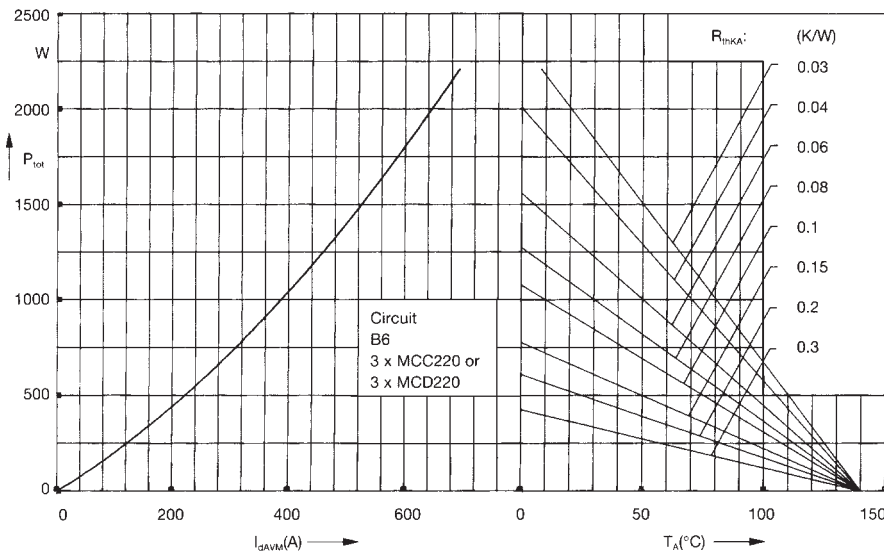

Fig. 6 Three phase rectifier bridge: Power dissipation versus direct output current and ambient temperature

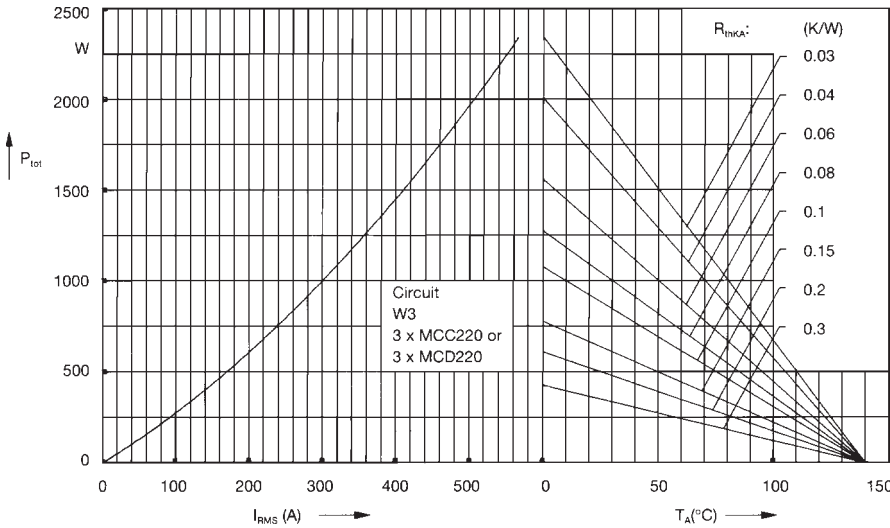

Fig. 7 Three phase AC-controller: Power dissipation versus RMS output current and ambient temperature

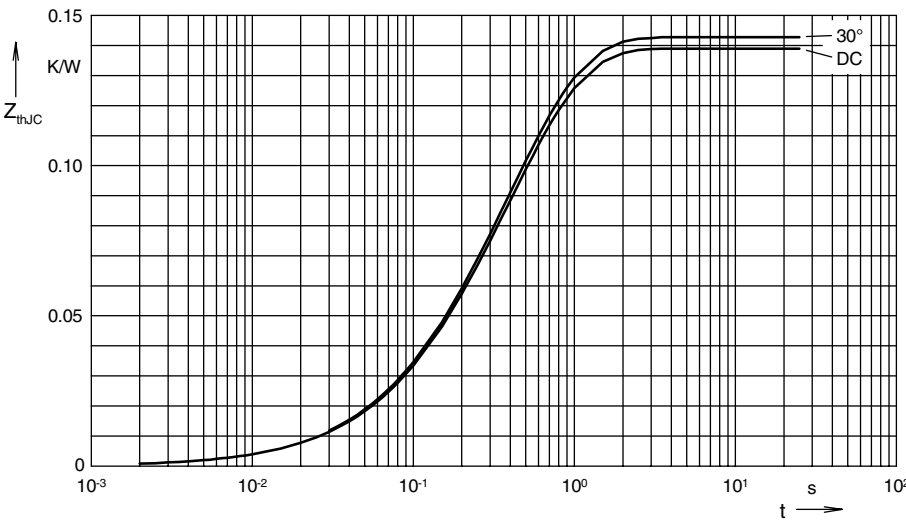

Fig. 8 Transient thermal impedance junction to case (per thyristor or diode)

$R_{thjC}$  for various conduction angles  $d$ :

$d$	$R_{thjC}$ (K/W)
DC	0.139
180°C	0.141
120°C	0.142
60°C	0.142
30°C	0.143

Constants for  $Z_{thjC}$  calculation:

$i$	$R_{thi}$ (K/W)	$t_i$ (s)
1	0.0037	0.0099
2	0.0177	0.168
3	0.1175	0.456

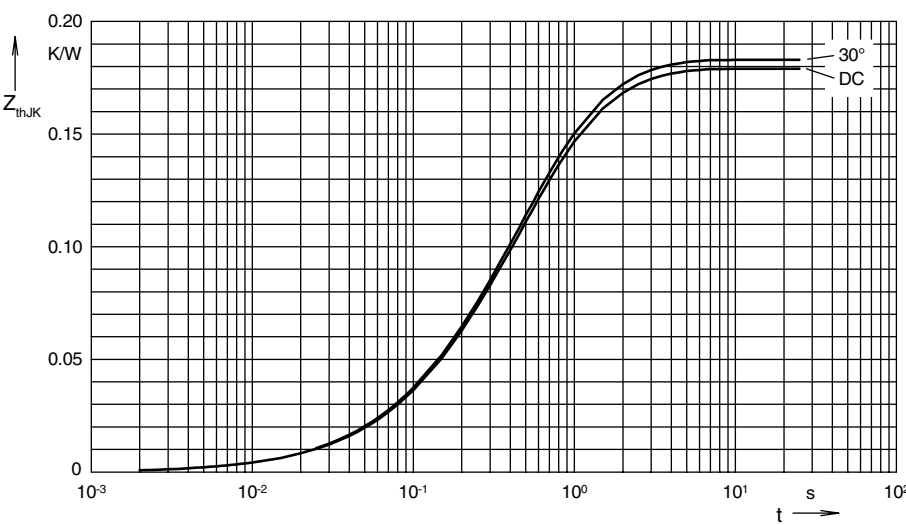

Fig. 9 Transient thermal impedance junction to heatsink (per thyristor or diode)

$R_{thjK}$  for various conduction angles  $d$ :

$d$	$R_{thjK}$ (K/W)
DC	0.179
180°C	0.181
120°C	0.182
60°C	0.183
30°C	0.183

Constants for  $Z_{thjK}$  calculation:

$i$	$R_{thi}$ (K/W)	$t_i$ (s)
1	0.0037	0.0099
2	0.0177	0.168
3	0.1175	0.456
4	0.04	1.36