

# Thyristor Modules

$I_{TRMS} = 2x340 \text{ A}$   
 $I_{TAVM} = 2x196 \text{ A}$   
 $V_{RRM} = 1400-1800 \text{ V}$

$V_{RSM}$	$V_{RRM}$	Type
$V_{DSM}$	$V_{DRM}$	
V	V	
1500	1400	MCC 200-14io1 MCD 200-14io1
1700	1600	MCC 200-16io1 MCD 200-16io1
1900	1800	MCC 200-18io1 MCD 200-18io1

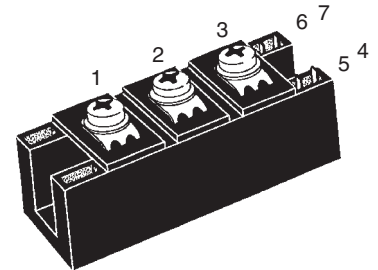
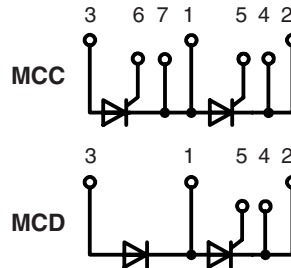

Symbol	Conditions	Maximum Ratings	
$I_{TRMS}/I_{FRMS}$	$T_{VJ} = T_{VJM}$	340	A
$I_{TAVM}/I_{FAVM}$	$T_C = 90^\circ\text{C}; 180^\circ \text{ sine}$	196	A
	$T_C = 85^\circ\text{C}; 180^\circ \text{ sine}$	216	A
$I_{TSM}/I_{FSM}$	$T_{VJ} = 45^\circ\text{C}; V_R = 0$	t = 10 ms (50 Hz), sine t = 8.3 ms (60 Hz), sine	8000 A 8600 A
	$T_{VJ} = T_{VJM}; V_R = 0$	t = 10 ms (50 Hz), sine t = 8.3 ms (60 Hz), sine	7000 A 7500 A
$\int i^2 dt$	$T_{VJ} = 45^\circ\text{C}; V_R = 0$	t = 10 ms (50 Hz), sine t = 8.3 ms (60 Hz), sine	320 000 A <sup>2</sup> s 311 000 A <sup>2</sup> s
	$T_{VJ} = T_{VJM}; V_R = 0$	t = 10 ms (50 Hz), sine t = 8.3 ms (60 Hz), sine	245 000 A <sup>2</sup> s 236 000 A <sup>2</sup> s
$(di/dt)_{cr}$	$T_{VJ} = T_{VJM}; f = 50\text{Hz}; t_p = 200\mu\text{s}; V_D = 2/3 V_{DRM}; I_G = 0.5 \text{ A}; di_G/dt = 0.5 \text{ A}/\mu\text{s}$	repetitive; $I_T = 500 \text{ A}$	100 A/ $\mu\text{s}$
		non repetitive; $I_T = 500 \text{ A}$	500 A/ $\mu\text{s}$
$(dv/dt)_{cr}$	$T_{VJ} = T_{VJM}; V_{DR} = 2/3 V_{DRM}; R_{GK} = \infty; \text{method 1 (linear voltage rise)}$		1000 V/ $\mu\text{s}$
$P_{GM}$	$T_{VJ} = T_{VJM}; t_p = 30 \mu\text{s}; I_T = I_{TAVM}; t_p = 500 \mu\text{s}$	120 W 60 W	
$P_{GAV}$		20 W	
$V_{RGM}$		10 V	
$T_{VJ}$		-40...+125 °C	
$T_{VJM}$		125 °C	
$T_{stg}$		-40...+125 °C	
$V_{ISOL}$	50/60 Hz, RMS; $I_{ISOL} \leq 1 \text{ mA};$	t = 1 min t = 1 s	3000 V~ 3600 V~
$M_d$	Mounting torque (M6) Terminal connection torque (M6)	2.25-2.75/20-25 Nm/lb.in. 4.5-5.5/40-48 Nm/lb.in.	
<b>Weight</b>	Typical including screws	125 g	

## Features

- International standard package
- Direct copper bonded Al<sub>2</sub>O<sub>3</sub> -ceramic base plate
- Planar passivated chips
- Isolation voltage 3600 V~
- UL registered, E 72873
- Keyed gate/cathode twin pins

## Applications

- Motor control
- Power converter
- Heat and temperature control for industrial furnaces and chemical processes
- Lighting control
- Contactless switches

## Advantages

- Space and weight savings
- Simple mounting
- Improved temperature and power cycling
- Reduced protection circuits

Data according to IEC 60747 and refer to a single thyristor/diode unless otherwise stated.

IXYS reserves the right to change limits, test conditions and dimensions

© 2004 IXYS All rights reserved

Symbol	Conditions	Characteristic Values
$I_{RRM}, I_{DRM}$	$T_{VJ} = T_{VJM}; V_R = V_{RRM}; V_D = V_{DRM}$	15 mA
$V_T/V_F$	$I_T, I_F = 200 \text{ A}; T_{VJ} = 25^\circ\text{C}$	1.20 V
$V_{T0}$	For power-loss calculations only ( $T_{VJ} = 125^\circ\text{C}$ )	0.8 V
$r_T$		1.0 mΩ
$V_{GT}$	$V_D = 6 \text{ V}; T_{VJ} = 25^\circ\text{C}$	2 V
	$T_{VJ} = -40^\circ\text{C}$	3 V
$I_{GT}$	$V_D = 6 \text{ V}; T_{VJ} = 25^\circ\text{C}$	150 mA
	$T_{VJ} = -40^\circ\text{C}$	220 mA
$V_{GD}$	$T_{VJ} = T_{VJM}; V_D = \frac{2}{3} V_{DRM}$	0.25 V
$I_{GD}$		10 mA
$I_L$	$T_{VJ} = 25^\circ\text{C}; t_p = 30 \mu\text{s}; V_D = 6 \text{ V}$ $I_G = 0.5 \text{ A}; di_G/dt = 0.5 \text{ A}/\mu\text{s}$	200 mA
$I_H$	$T_{VJ} = 25^\circ\text{C}; V_D = 6 \text{ V}; R_{GK} = \infty$	150 mA
$t_{gd}$	$T_{VJ} = 25^\circ\text{C}; V_D = \frac{1}{2} V_{DRM}$ $I_G = 0.5 \text{ A}; di_G/dt = 0.5 \text{ A}/\mu\text{s}$	2 μs
$t_q$	$T_{VJ} = T_{VJM}; I_T = 300 \text{ A}, t_p = 200 \mu\text{s}; -di/dt = 10 \text{ A}/\mu\text{s}$ typ. $V_R = 100 \text{ V}; dv/dt = 50 \text{ V}/\mu\text{s}; V_D = \frac{2}{3} V_{DRM}$	200 μs
$Q_S$	$T_{VJ} = T_{VJM}; I_T = 300 \text{ A}, -di/dt = 50 \text{ A}/\mu\text{s}$	550 μC
$I_{RM}$		235 A
$R_{thJC}$	per thyristor; DC current	0.13 K/W
	per module	0.065 K/W
$R_{thJH}$	per thyristor; DC current	0.18 K/W
	per module	0.09 K/W
$d_s$	Creepage distance on surface	12.7 mm
$d_A$	Strike distance through air	9.6 mm
$a$	Maximum allowable acceleration	50 m/s <sup>2</sup>

### Optional accessories for modules

Keyed gate/cathode twin plugs with wire length = 350 mm, gate = yellow, cathode = red

Type **ZY 180L** (L = Left for pin pair 4/5) } UL 758, style 1385,

Type **ZY 180R** (R = right for pin pair 6/7) } CSA class 5851, guide 460-1-1

### Dimensions in mm (1 mm = 0.0394")

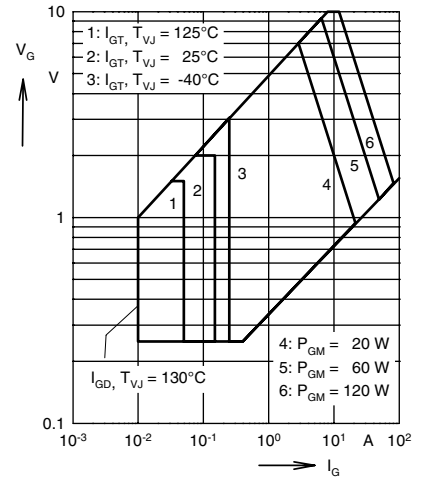
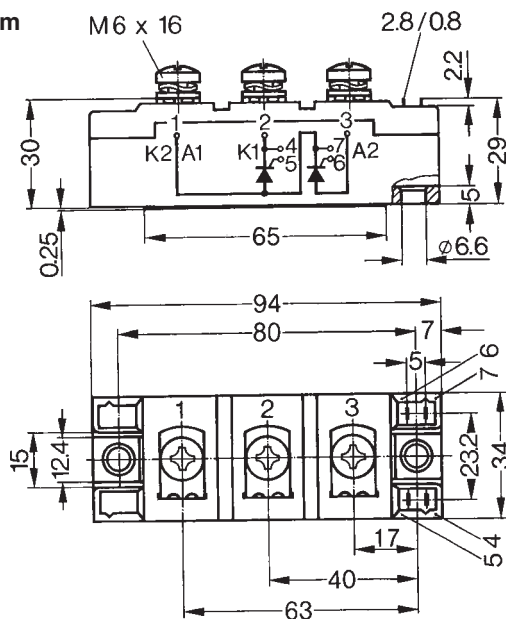

Fig. 1 Gate trigger characteristics

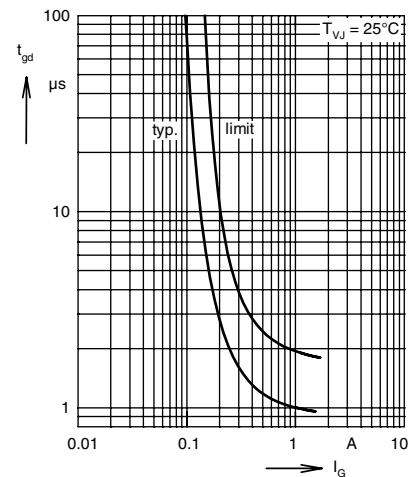

Fig. 2 Gate trigger delay time

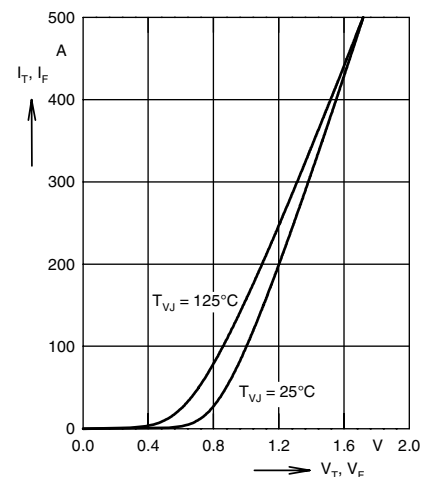

Fig. 3 Forward current versus voltage drop

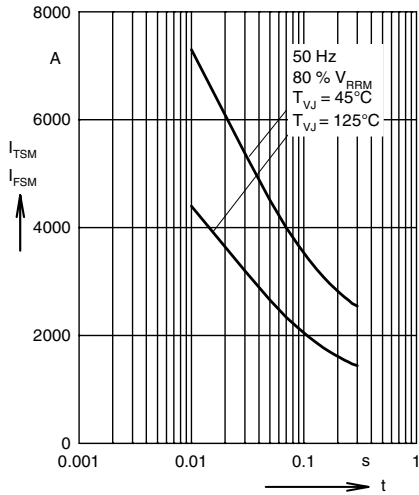

Fig. 4 Surge overload current  
 $I_{TSM}/I_{FSM}$ : Crest value, t: duration

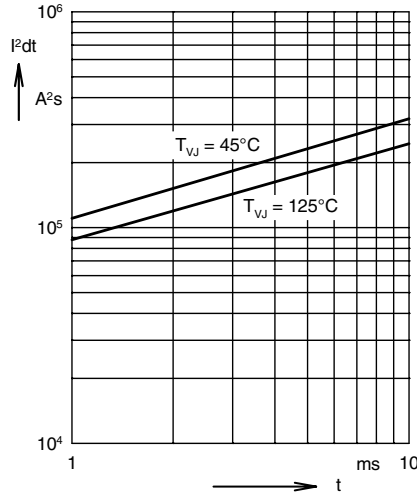

Fig. 5  $I^2dt$  versus time (1-10 ms)

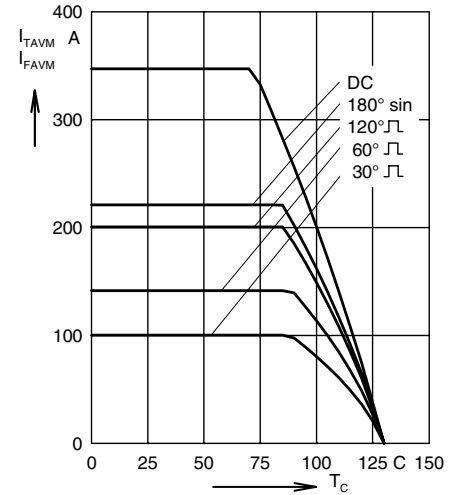

Fig. 6 Maximum forward current at case temperature

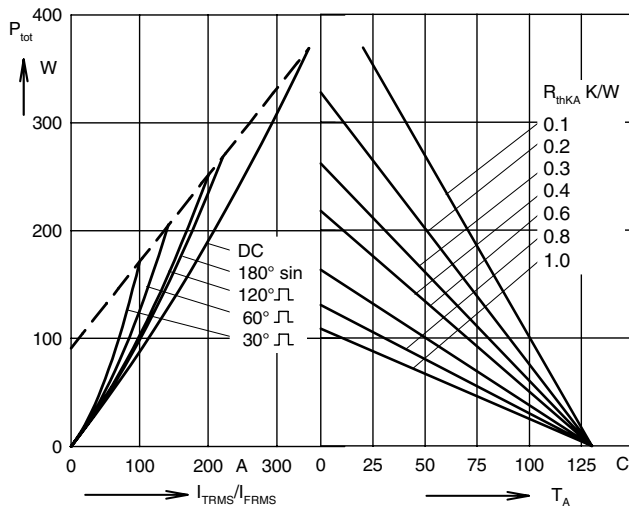

Fig. 7 Power dissipation versus on-state current and ambient temperature (per thyristor or diode)

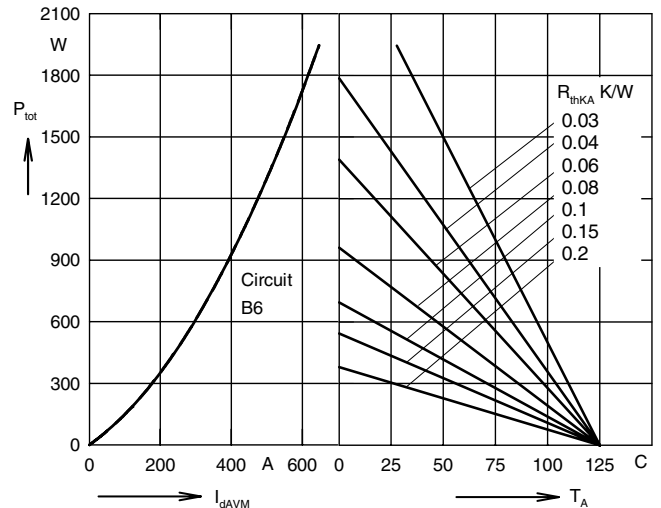

Fig. 8 3~ rectifier bridge: Power dissipation versus direct output current and ambient temperature

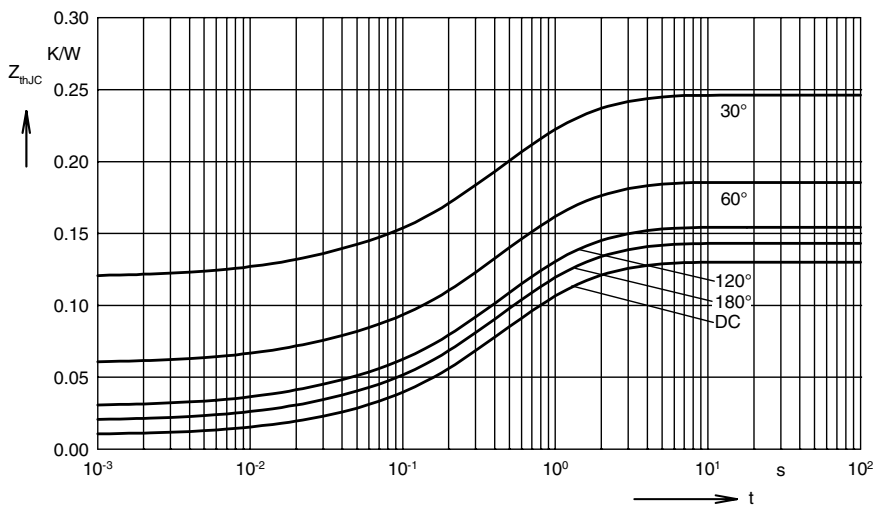

Fig. 9 Transient thermal impedance junction to case at various condition angles (per thyristor or diode)

Constants for  $Z_{thJC}$  calculation (DC):

i	$R_{thi}$ (K/W)	$t_i$ (s)
1	0.01	0.00014
2	0.0065	0.019
3	0.025	0.18
4	0.0615	0.52
5	0.027	1.6