

DATA SHEET

SMV1232-040LF: Surface Mount, 0402 Silicon Hyperabrupt Tuning Varactor Diode

Applications

- Wide bandwidth VCOs
- Wide range voltage-tuned phase shifters and filters

Features

- Low series resistance: 1.2 Ω typical
- High capacitance ratio at low reverse voltage: CT1/CT3 = 1.7 typical
- Industry-standard 0402 footprint
- Packages rated MSL1, 260 °C per JEDEC J-STD-020

NEW Skyworks offers lead (Pb)-free, RoHS (Restriction of Hazardous Substances)-compliant packaging.



Description

The SMV1232-040LF is a silicon hyperabrupt junction varactor diode specifically designed for 3 V platforms. The specified high capacitance ratio and low reverse voltage make this varactor appropriate for low phase noise Voltage Controlled Oscillators (VCOs) used at frequencies in wireless systems up to and above 2.5 GHz.

The SMV1232-040L is compatible with the industry-standard 0402 PCB footprint.

Table 1. SMV1232-040LF Absolute Maximum Ratings

Parameter	Symbol	Minimum	Maximum	Units
Forward current	I _F		20	mA
Reverse voltage	V _R		15	V
Dissipated power @ 25 °C	P _D		750	mW
Storage temperature	T _{STG}	-55	+200	°C
Junction temperature	T _J	-55	+175	°C
Solder interface temperature	T _S	-40	+85	°C

Note: Exposure to maximum rating conditions for extended periods may reduce device reliability. There is no damage to device with only one parameter set at the limit and all other parameters set at or below their nominal value. Exceeding any of the limits listed here may result in permanent damage to the device.

CAUTION: Although this device is designed to be as robust as possible, Electrostatic Discharge (ESD) can damage this device. This device must be protected at all times from ESD. Static charges may easily produce potentials of several kilovolts on the human body or equipment, which can discharge without detection. Industry-standard ESD precautions should be used at all times.

Table 2. SMV1232-040LF Electrical Specifications (Note 1)
(T_s = +25 °C, Characteristic Impedance [Z₀] = 50 Ω, Unless Otherwise Noted)

Parameter	Symbol	Test Condition	Min	Typical	Max	Units
Reverse current	I _R	V _R = 12 V			20	nA
Capacitance	C _T	f = 1 MHz V _R = 1 V V _R = 3 V	2.34	1.50	2.86	pF pF
Capacitance ratio	C _{TR}	C _T @ 1 V/C _T @ 3 V C _T @ 1 V/C _T @ 6 V	1.5 2.6		1.9 3.4	- -
Series resistance	R _S	f = 500 MHz, V _R = 3 V			1.5	Ω
Series inductance	L _S			0.45		nH
Breakdown voltage	V _{BR}	I _R = 10 μA	15			V

Note 1: Performance is guaranteed only under the conditions listed in this Table.

Electrical and Mechanical Specifications

The absolute maximum ratings of the SMV1232-040LF are provided in Table 1. Electrical specifications are provided in Table 2. Table 3 summarizes the capacitance for reverse voltages between 0 and 20 V.

Typical performance characteristics of the SMV1232-040LF are illustrated in Figures 1 and 2.

The SPICE model for the SMV1232-040LF varactor is shown in Figure 3 and the associated model parameters are provided in Table 4.

Package Dimensions

The PCB layout footprint for the SMV1232-040LF is provided in Figure 4. Typical case markings are shown in Figure 5. Package dimensions for the SMV1232-040LF are provided in Figure 6. Tape and reel dimensions are provided in Figure 7.

Package and Handling Information

Instructions on the shipping container label regarding exposure to moisture after the container seal is broken must be followed. Otherwise, problems related to moisture absorption may occur when the part is subjected to high temperature during solder assembly.

The SMV1232-040LF is rated to Moisture Sensitivity Level 1 (MSL1) at 260 °C. It can be used for lead or lead-free soldering. For additional information, refer to the Skyworks Application Note, *Solder Reflow Information*, document number 200164.

Care must be taken when attaching this product, whether it is done manually or in a production solder reflow environment. Production quantities of this product are shipped in a standard tape and reel format.

Table 3. Capacitance vs Reverse Voltage

V _R (V)	C _T (pF)
0	3.84
1	2.52
2	1.91
3	1.48
4	1.18
5	0.99
6	0.86
7	0.77
8	0.71
9	0.67
10	0.65
12	0.63
14	0.61
16	0.60
18	0.59
20	0.59

Typical Performance Characteristics

(T_A = 25 °C, Unless Otherwise Noted)

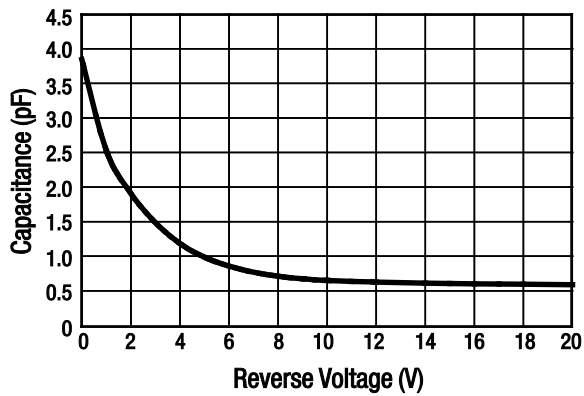

Figure 1. Capacitance vs Reverse Voltage

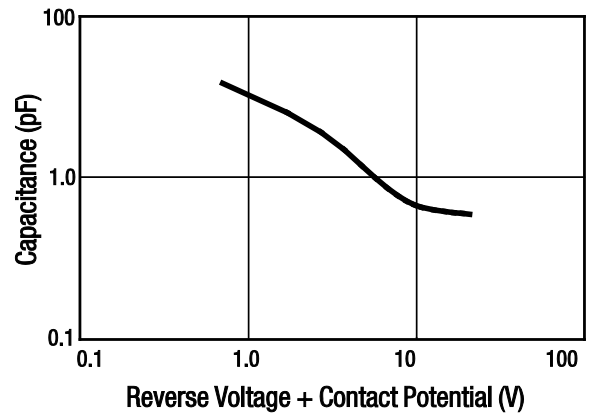

Figure 2. Capacitance vs Reverse Voltage + Contact Potential

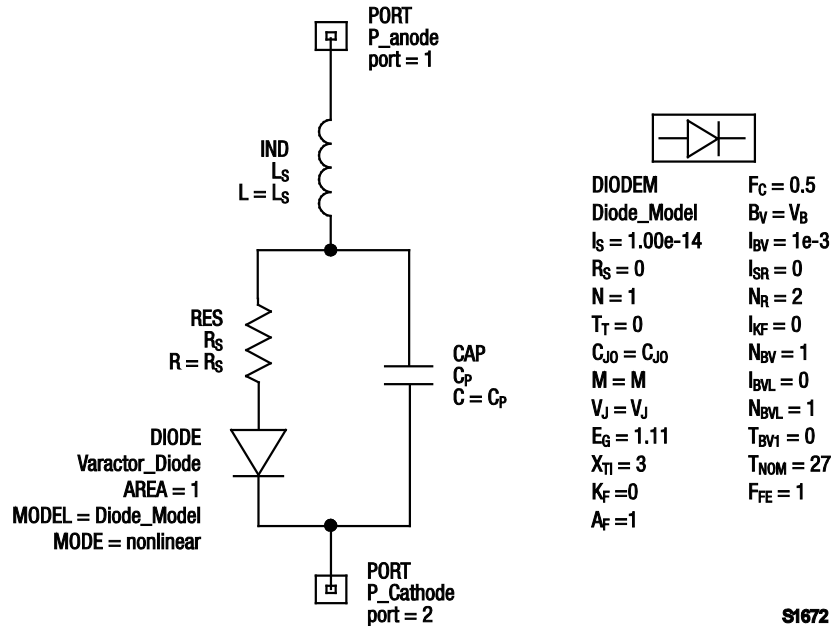
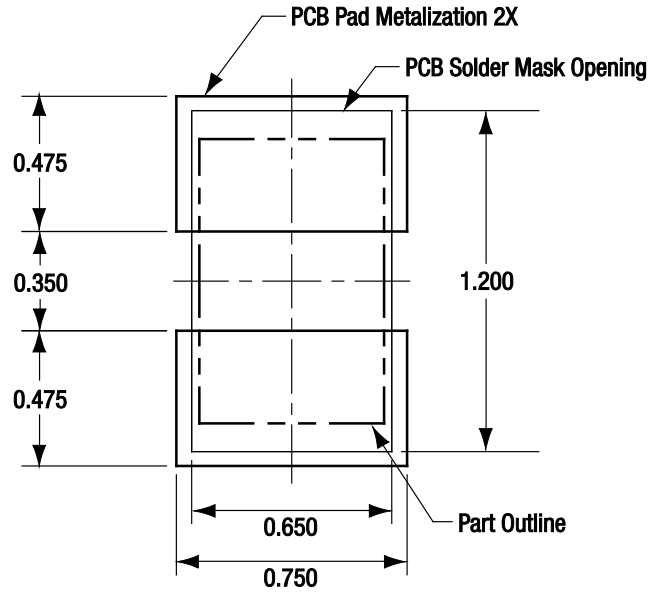

Figure 3. SPICE Model

Table 4. SPICE Model Parameters

Part Number	Cj0 (pF)	Vj (V)	M	Cp (pF)	Rs (Ω)	Ls (nH)
SMV1232-040LF	4	1.7	1.05	0.1	1.2	0.45



All measurements in millimeters

S1997

Figure 4. SMV1232-040LF PCB Layout Footprint

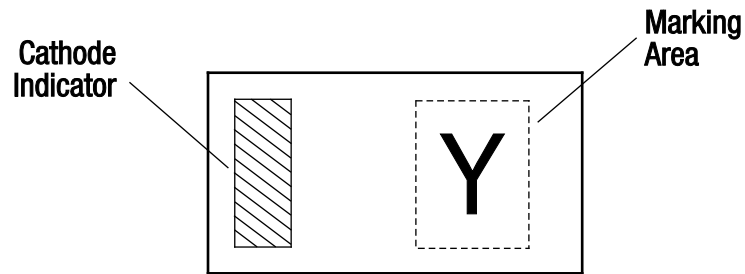
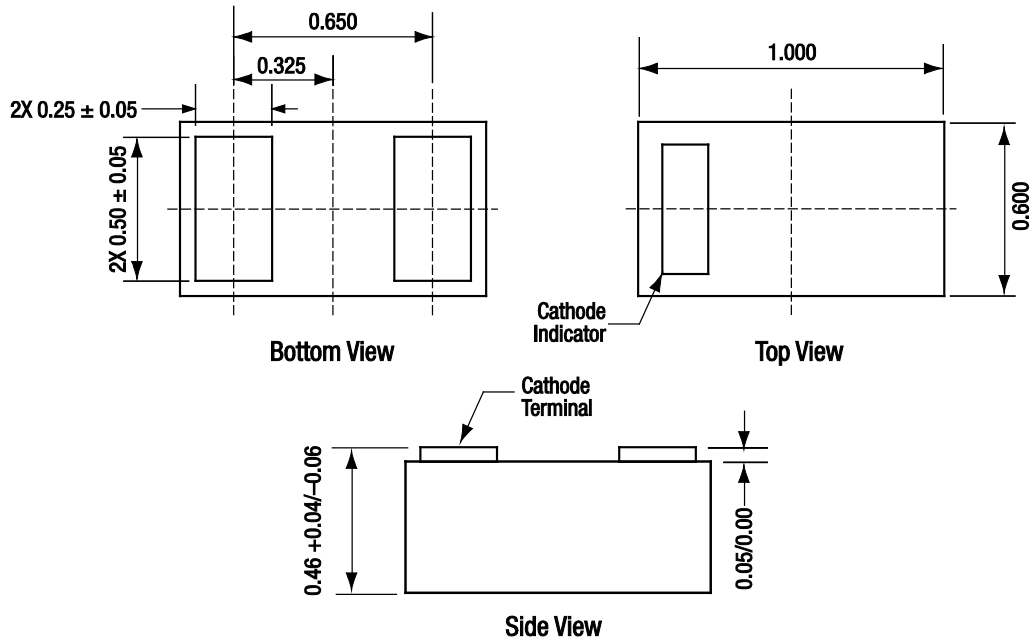

Figure 5. Typical Case Markings (Top View)



All dimensions in millimeters

S1892

Figure 6. SMV1232-040LF Package Dimensions

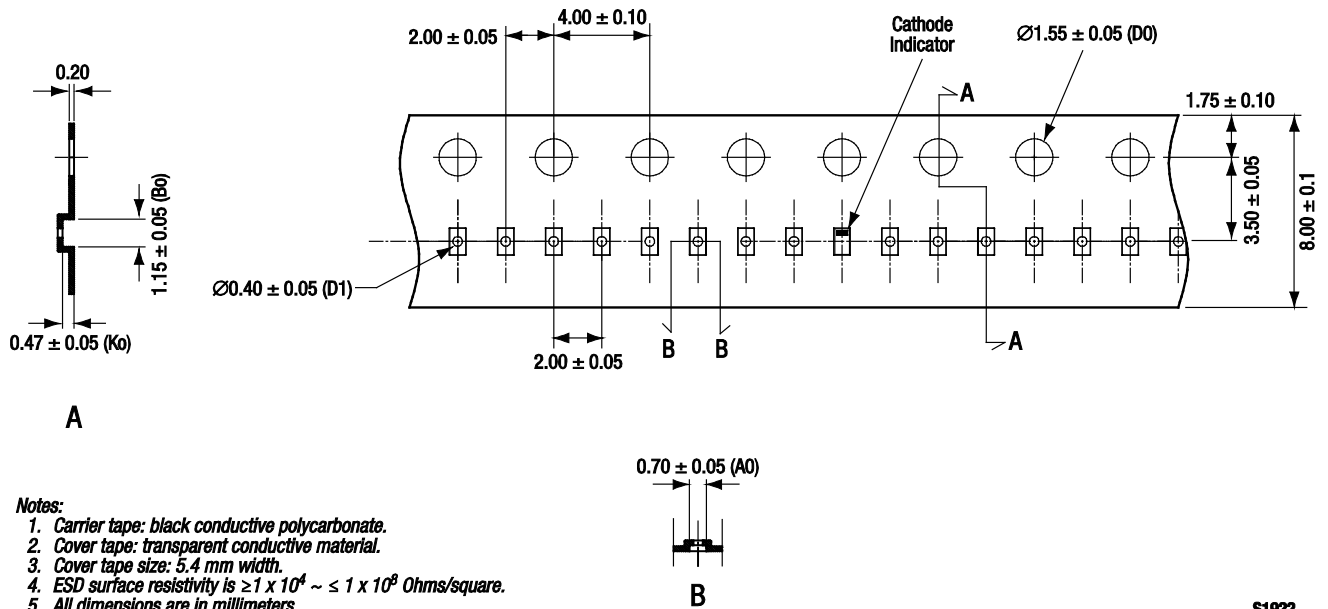

Notes:

1. Carrier tape: black conductive polycarbonate.
2. Cover tape: transparent conductive material.
3. Cover tape size: 5.4 mm width.
4. ESD surface resistivity is $\geq 1 \times 10^4 \sim \leq 1 \times 10^8$ Ohms/square.
5. All dimensions are in millimeters.

S1922

Figure 7. SMV1232-040LF Tape and Reel Dimensions

Ordering Information

Model Name	Manufacturing Part Number
SMV1232-040LF Surface Mount Hyperabrupt Tuning Varactor Diode	SMV1232-040LF

Copyright © 2010 Skyworks Solutions, Inc. All Rights Reserved.

Information in this document is provided in connection with Skyworks Solutions, Inc. ("Skyworks") products or services. These materials, including the information contained herein, are provided by Skyworks as a service to its customers and may be used for informational purposes only by the customer. Skyworks assumes no responsibility for errors or omissions in these materials or the information contained herein. Skyworks may change its documentation, products, services, specifications or product descriptions at any time, without notice. Skyworks makes no commitment to update the materials or information and shall have no responsibility whatsoever for conflicts, incompatibilities, or other difficulties arising from any future changes.

No license, whether express, implied, by estoppel or otherwise, is granted to any intellectual property rights by this document. Skyworks assumes no liability for any materials, products or information provided hereunder, including the sale, distribution, reproduction or use of Skyworks products, information or materials, except as may be provided in Skyworks Terms and Conditions of Sale.

THE MATERIALS, PRODUCTS AND INFORMATION ARE PROVIDED "AS IS" WITHOUT WARRANTY OF ANY KIND, WHETHER EXPRESS, IMPLIED, STATUTORY, OR OTHERWISE, INCLUDING FITNESS FOR A PARTICULAR PURPOSE OR USE, MERCHANTABILITY, PERFORMANCE, QUALITY OR NON-INFRINGEMENT OF ANY INTELLECTUAL PROPERTY RIGHT; ALL SUCH WARRANTIES ARE HEREBY EXPRESSLY DISCLAIMED. SKYWORKS DOES NOT WARRANT THE ACCURACY OR COMPLETENESS OF THE INFORMATION, TEXT, GRAPHICS OR OTHER ITEMS CONTAINED WITHIN THESE MATERIALS. SKYWORKS SHALL NOT BE LIABLE FOR ANY DAMAGES, INCLUDING BUT NOT LIMITED TO ANY SPECIAL, INDIRECT, INCIDENTAL, STATUTORY, OR CONSEQUENTIAL DAMAGES, INCLUDING WITHOUT LIMITATION, LOST REVENUES OR LOST PROFITS THAT MAY RESULT FROM THE USE OF THE MATERIALS OR INFORMATION, WHETHER OR NOT THE RECIPIENT OF MATERIALS HAS BEEN ADVISED OF THE POSSIBILITY OF SUCH DAMAGE.

Skyworks products are not intended for use in medical, lifesaving or life-sustaining applications, or other equipment in which the failure of the Skyworks products could lead to personal injury, death, physical or environmental damage. Skyworks customers using or selling Skyworks products for use in such applications do so at their own risk and agree to fully indemnify Skyworks for any damages resulting from such improper use or sale.

Customers are responsible for their products and applications using Skyworks products, which may deviate from published specifications as a result of design defects, errors, or operation of products outside of published parameters or design specifications. Customers should include design and operating safeguards to minimize these and other risks. Skyworks assumes no liability for applications assistance, customer product design, or damage to any equipment resulting from the use of Skyworks products outside of stated published specifications or parameters.

Skyworks, the Skyworks symbol, and "Breakthrough Simplicity" are trademarks or registered trademarks of Skyworks Solutions, Inc., in the United States and other countries. Third-party brands and names are for identification purposes only, and are the property of their respective owners. Additional information, including relevant terms and conditions, posted at www.skyworksinc.com, are incorporated by reference.