

# Fast Recovery Epitaxial Diode (FRED) Module

## MEK 350-02 DA

$V_{RRM} = 200\text{ V}$   
 $I_{FAVM} = 356\text{ A}$   
 $t_{rr} = 150\text{ ns}$

$V_{RSM}$	$V_{RRM}$	Type
V	V	
200	200	MEK 350-02DA

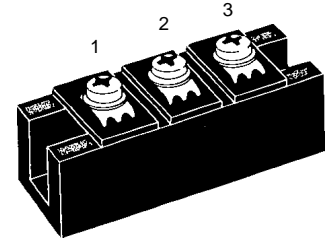
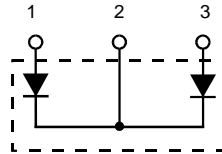

Symbol	Test Conditions	Maximum Ratings	
$I_{FRMS}$	$T_C = 75^\circ\text{C}$	503	A
$I_{FAVM}$ ①	$T_C = 75^\circ\text{C}$ ; rectangular, $d = 0.5$	356	A
$I_{FRM}$	$t_p < 10\ \mu\text{s}$ ; rep. rating, pulse width limited by $T_{VJM}$	1800	A
$I_{FSM}$	$T_{VJ} = 45^\circ\text{C}$ ; $t = 10\text{ ms}$ (50 Hz), sine	2400	A
	$t = 8.3\text{ ms}$ (60 Hz), sine	2640	A
	$T_{VJ} = 150^\circ\text{C}$ ; $t = 10\text{ ms}$ (50 Hz), sine	2160	A
	$t = 8.3\text{ ms}$ (60 Hz), sine	2380	A
$I^2t$	$T_{VJ} = 45^\circ\text{C}$ ; $t = 10\text{ ms}$ (50 Hz), sine	28800	A <sup>2</sup> s
	$t = 8.3\text{ ms}$ (60 Hz), sine	29300	A <sup>2</sup> s
	$T_{VJ} = 150^\circ\text{C}$ ; $t = 10\text{ ms}$ (50 Hz), sine	23300	A <sup>2</sup> s
	$t = 8.3\text{ ms}$ (60 Hz), sine	23800	A <sup>2</sup> s
$T_{VJ}$		-40...+150	°C
$T_{stg}$		-40...+125	°C
$T_{Smax}$		110	°C
$P_{tot}$	$T_C = 25^\circ\text{C}$	875	W
$V_{ISOL}$	50/60 Hz, RMS $t = 1\text{ min}$	3000	V~
	$I_{ISOL} \leq 1\text{ mA}$ $t = 1\text{ s}$	3600	V~
$M_d$	Mounting torque (M6)	2.25-2.75/20-25	Nm/lb.in.
	Terminal connection torque (M6)	4.50-5.50/40-48	Nm/lb.in.
$d_s$	Creeping distance on surface	12.7	mm
$d_A$	Strike distance through air	9.6	mm
$a$	Maximum allowable acceleration	50	m/s <sup>2</sup>
<b>Weight</b>		150	g

### Features

- International standard package with DCB ceramic base plate
- Planar passivated chips
- Short recovery time
- Low switching losses
- Soft recovery behaviour
- Isolation voltage 3600 V~
- UL registered E 72873

### Applications

- Antiparallel diode for high frequency switching devices
- Free wheeling diode in converters and motor control circuits
- Inductive heating and melting
- Uninterruptible power supplies (UPS)
- Ultrasonic cleaners and welders

### Advantages

- High reliability circuit operation
- Low voltage peaks for reduced protection circuits
- Low noise switching
- Low losses

Symbol	Test Conditions	Characteristic Values (per diode)		
		typ.	max.	
$I_R$	$T_{VJ} = 25^\circ\text{C}$ $V_R = V_{RRM}$		3 mA	
	$T_{VJ} = 25^\circ\text{C}$ $V_R = 0.8 \cdot V_{RRM}$		2 mA	
	$T_{VJ} = 125^\circ\text{C}$ $V_R = 0.8 \cdot V_{RRM}$		80 mA	
$V_F$	$I_F = 150\text{ A}$ ; $T_{VJ} = 125^\circ\text{C}$		0.80 V	
	$T_{VJ} = 25^\circ\text{C}$		0.98 V	
	$I_F = 260\text{ A}$ ; $T_{VJ} = 125^\circ\text{C}$		0.92 V	
	$T_{VJ} = 25^\circ\text{C}$		1.07 V	
$V_{TO}$	For power-loss calculations only		0.53 V	
$r_T$			1.29 mΩ	
$R_{thJH}$	DC current		0.228 K/W	
$R_{thJC}$	DC current		0.143 K/W	
$t_{rr}$ $I_{RM}$	$I_F = 300\text{ A}$ $V_R = 100\text{ V}$ $-di/dt = 200\text{ A}/\mu\text{s}$	150	$T_{VJ} = 100^\circ\text{C}$	200 ns
			$T_{VJ} = 25^\circ\text{C}$	9 A
			$T_{VJ} = 100^\circ\text{C}$	15 A

①  $I_{FAVM}$  rating includes reverse blocking losses at  $T_{VJM}$ ,  $V_R = 0.6 V_{RRM}$ , duty cycle  $d = 0.5$   
Data according to IEC 60747

IXYS reserves the right to change limits, test conditions and dimensions

### Dimensions in mm (1 mm = 0.0394")

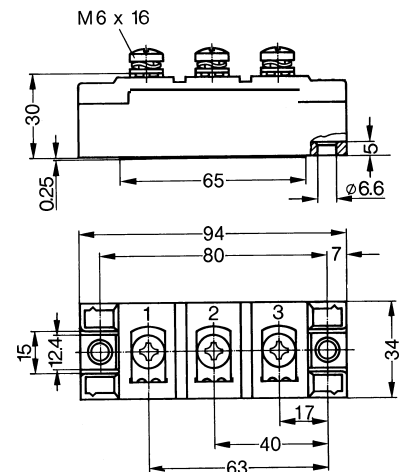

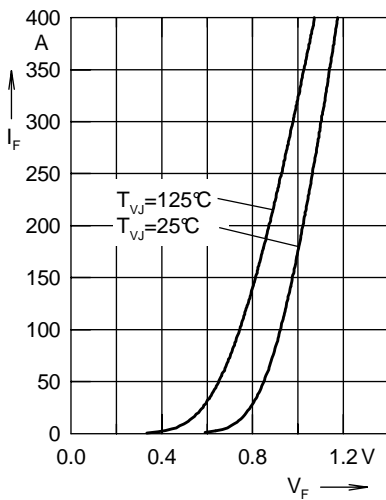
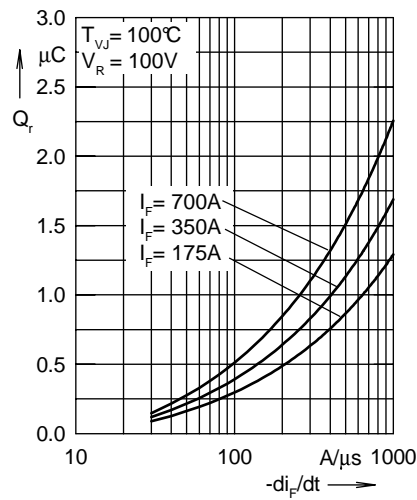
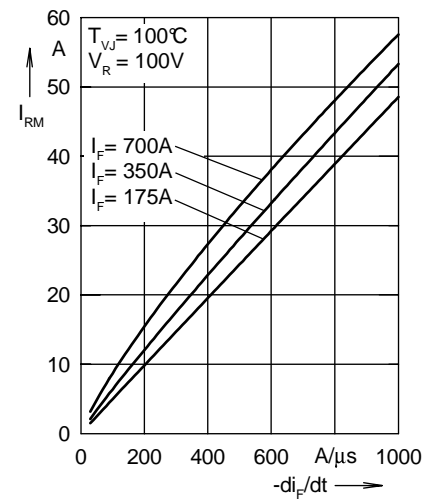
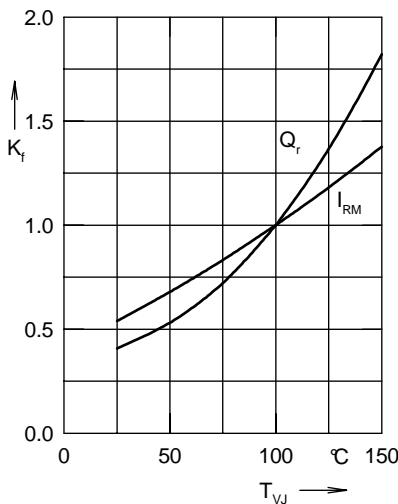
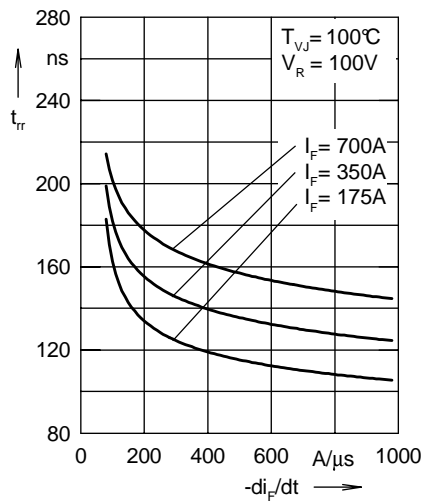
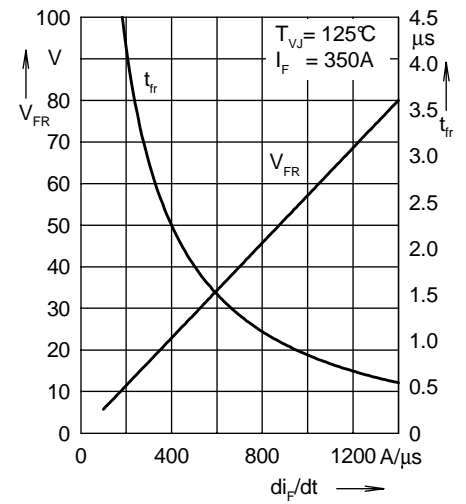
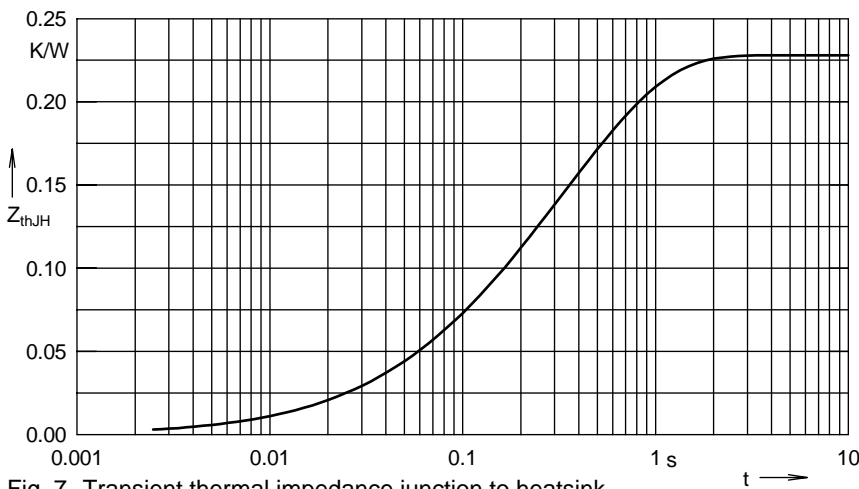

 Fig. 1 Forward current  $I_F$  versus voltage drop  $V_F$  per leg

 Fig. 2 Reverse recovery charge  $Q_r$  versus  $-di_F/dt$ 

 Fig. 3 Peak reverse current  $I_{RM}$  versus  $-di_F/dt$ 

 Fig. 4 Dynamic parameters  $Q_r$ ,  $I_{RM}$  versus junction temperature  $T_{VJ}$ 

 Fig. 5 Recovery time  $t_{rr}$  versus  $-di_F/dt$ 

 Fig. 6 Peak forward voltage  $V_{FR}$  and  $t_{fr}$  versus  $di_F/dt$ 

Fig. 7 Transient thermal impedance junction to heatsink

 Constants for  $Z_{thJS}$  calculation:

i	$R_{thi}$ (K/W)	$t_i$ (s)
1	0.002	0.08
2	0.008	0.024
3	0.054	0.112
4	0.164	0.464