



# MIC5235

## Ultra-Low Quiescent Current, 150mA $\mu$ Cap LDO Regulator

### General Description

The MIC5235 is a 150mA highly accurate, low dropout regulator with high input voltage and ultra-low ground current. This combination of high voltage and low ground current makes the MIC5235 ideal for USB and portable electronics applications, using 1-cell, 2-cell or 3-cell Li-Ion battery inputs.

A  $\mu$ Cap LDO design, the MIC5235 is stable with either ceramic or tantalum output capacitor. It only requires a 2.2 $\mu$ F capacitor for stability.

Features of the MIC5235 includes enable input, thermal shutdown, current limit, reverse battery protection, and reverse leakage protection.

Available in fixed and adjustable output voltage versions, the MIC5235 is offered in the IttyBitty<sup>®</sup> SOT-23-5 package with a junction temperature range of  $-40^{\circ}\text{C}$  to  $+125^{\circ}\text{C}$ .

### Features

- Wide input voltage range: 2.3V to 24V
- Ultra low ground current: 18 $\mu\text{A}$
- Low dropout voltage: 310mV at 150mA
- High output accuracy:  $\pm 2.0\%$  over temperature
- $\mu$ Cap: stable with ceramic or tantalum capacitors
- Excellent line and load regulation specifications
- Zero shutdown current
- Reverse battery protection
- Reverse leakage protection
- Thermal shutdown and current limit protection
- IttyBitty<sup>®</sup> SOT-23-5 package
- Adjustable output from 1.24V-20V

### Applications

- USB power supply
- Cellular phones
- Keep-alive supply in notebook and portable computers
- Logic supply for high-voltage batteries
- Automotive electronics
- Battery powered systems

### Typical Application

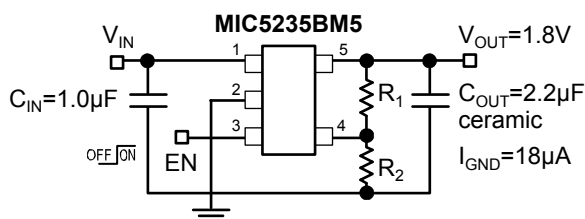

Ultra-Low Current Adjustable Regulator Application

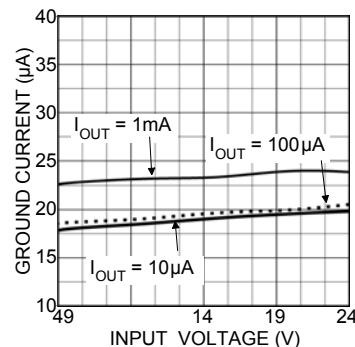

Ground Current vs. Input Voltage

IttyBitty is a registered trademark of Micrel, Inc

Micrel Inc. • 2180 Fortune Drive • San Jose, CA 95131 • USA • tel +1 (408) 944-0800 • fax + 1 (408) 474-1000 • <http://www.micrel.com>

## Ordering Information

Part Number		Marking Codes		Voltage**	Junction Temp. Range	Package
Standard	Pb-Free	Standard	Pb-Free*			
MIC5235-1.5BM5	MIC5235-1.5YM5	L215	<u>L</u> 215	1.5V	-40° to +125°C	5-Pin SOT-23
MIC5235-1.8BM5	MIC5235-1.8YM5	L218	<u>L</u> 218	1.8V	-40° to +125°C	5-Pin SOT-23
MIC5235-2.5BM5	MIC5235-2.5YM5	L225	<u>L</u> 225	2.5V	-40° to +125°C	5-Pin SOT-23
MIC5235-2.7BM5	MIC5235-2.7YM5	L227	<u>L</u> 227	2.7V	-40° to +125°C	5-Pin SOT-23
MIC5235-3.0BM5	MIC5235-3.0YM5	L230	<u>L</u> 230	3.0V	-40° to +125°C	5-Pin SOT-23
MIC5235-3.3BM5	MIC5235-3.3YM5	L233	<u>L</u> 233	3.3V	-40° to +125°C	5-Pin SOT-23
MIC5235-5.0BM5	MIC5235-5.0YM5	L250	<u>L</u> 250	5.0V	-40° to +125°C	5-Pin SOT-23
MIC5235BM5	MIC5235YM5	L2AA	<u>L</u> 2AA	Adj.	-40° to +125°C	5-Pin SOT-23

\* Under bar symbol (  ) may not be to scale.

\*\* Contact factory regarding availability for voltages not listed.

## Pin Configuration

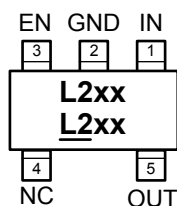

SOT-23-5 (Fixed)

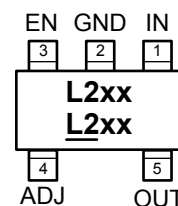

SOT-23-5 (Adjustable)

## Pin Description

Pin Number	Pin Name	Pin Function
1	IN	Supply Input.
2	GND	Ground.
3	EN	Enable (Input): Logic low = shutdown; logic high = enable.
4	NC (fixed)	No Connect.
	ADJ (adj.)	Adjust (Input): Feedback input. Connect to resistive voltage-divider network.
5	OUT	Regulator Output.

**Absolute Maximum Ratings<sup>(1)</sup>**

Input Supply Voltage .....	-20V to 38V
Enable Input Voltage.....	-0.3V to 38V
Power Dissipation .....	Internally Limited
Junction Temperature .....	-40°C to +125°C
Storage Temperature .....	-65°C to +150°C
ESD Rating <sup>(3)</sup>	

**Operating Ratings<sup>(2)</sup>**

Input Supply Voltage .....	2.3V to 24V
Enable Input Voltage.....	0V to 24V
Junction Thermal.....	-40°C to +125°C
Package Thermal Resistance	
SOT-23-5 ( $\theta_{JA}$ ).....	235°C/W

**Electrical Characteristics<sup>(4)</sup>**

$T_A = 25^\circ\text{C}$  with  $V_{IN} = V_{OUT} + 1\text{V}$ ;  $I_{OUT} = 100\mu\text{A}$ , **Bold** values indicate  $-40^\circ\text{C} < T_J < +125^\circ\text{C}$ ; unless otherwise specified.

Parameter	Condition	Min	Typ	Max	Units
Output Voltage Accuracy	Variation from nominal $V_{OUT}$	-1.0		+1.0	%
		<b>-2.0</b>		<b>+2.0</b>	%
Line Regulation	$V_{IN} = V_{OUT} + 1\text{V}$ to 24V		0.04		%
Load Regulation	Load = 100 $\mu\text{A}$ to 150mA		0.25	1	%
Dropout Voltage	$I_{OUT} = 100\mu\text{A}$		50		mV
	$I_{OUT} = 50\text{mA}$		230	300	mV
				<b>400</b>	mV
	$I_{OUT} = 100\text{mA}$		270	400	mV
				<b>450</b>	mV
	$I_{OUT} = 150\text{mA}$		310	450	mV
				<b>500</b>	mV
Reference Voltage		1.22	1.24	1.25	V
Ground Current	$I_{OUT} = 100\mu\text{A}$		18	30	$\mu\text{A}$
				<b>35</b>	$\mu\text{A}$
	$I_{OUT} = 50\text{mA}$		0.35	0.7	mA
	$I_{OUT} = 100\text{mA}$		1	2	mA
	$I_{OUT} = 150\text{mA}$		2	4	mA
Ground Current in Shutdown	$V_{EN} \leq 0.6\text{V}$ ; $V_{IN} = 24\text{V}$		0.1	1	$\mu\text{A}$
Short Circuit Current	$V_{OUT} = 0\text{V}$		350	<b>500</b>	mA
Output Leakage, Reverse Polarity Input	Load = 500 $\Omega$ ; $V_{IN} = -15\text{V}$		-0.1		$\mu\text{A}$
<b>Enable Input</b>					
Input Low Voltage	Regulator OFF			<b>0.6</b>	V
Input High Voltage	Regulator ON	<b>2.0</b>			V
Enable Input Current	$V_{EN} = 0.6\text{V}$ ; Regulator OFF	-1.0	0.01	1.0	$\mu\text{A}$
	$V_{EN} = 2.0\text{V}$ ; Regulator ON		0.1	1.0	$\mu\text{A}$
	$V_{EN} = 24\text{V}$ ; Regulator ON		0.5	2.5	$\mu\text{A}$

**Notes:**

1. Exceeding the absolute maximum rating may damage the device.
2. The device is not guaranteed to function outside its operating rating.
3. Devices are ESD sensitive. Handling precautions recommended. Human body model, 1.5k in series with 100pF.
4. Specification for packaged product only.

# Typical Characteristics

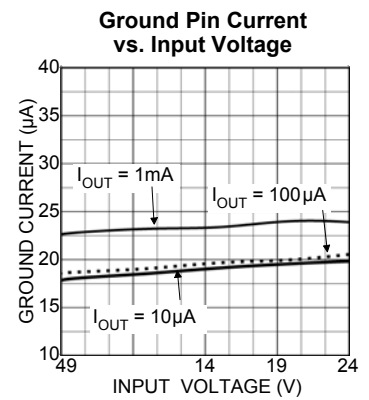
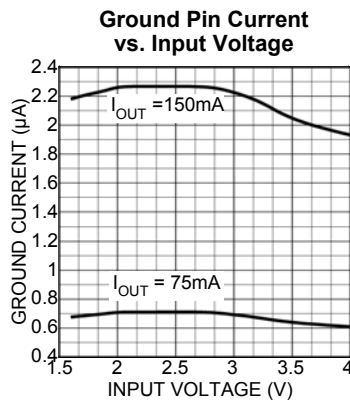
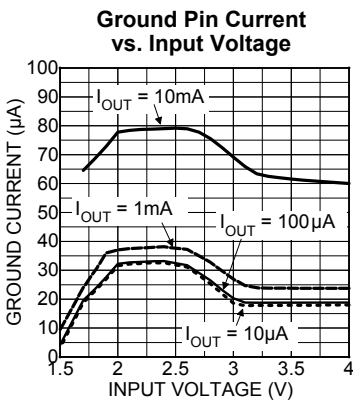
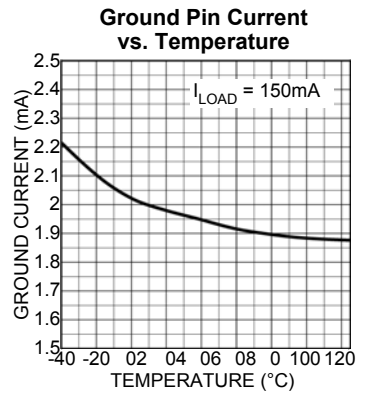
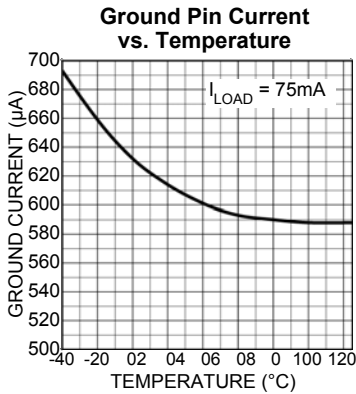
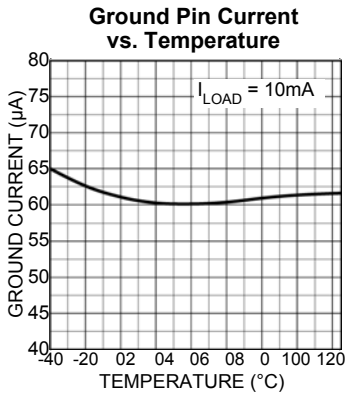
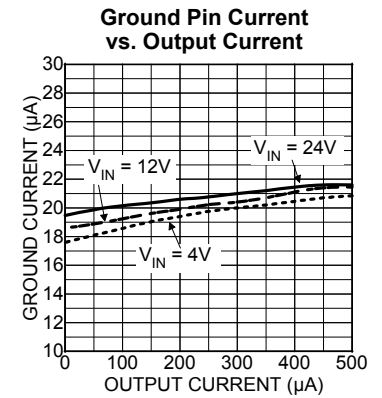
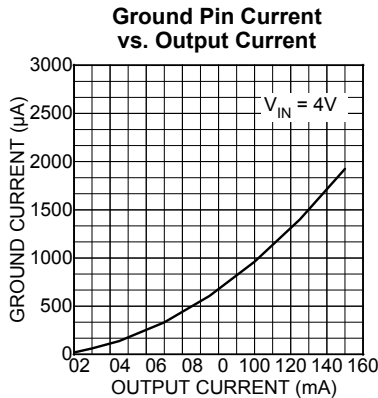
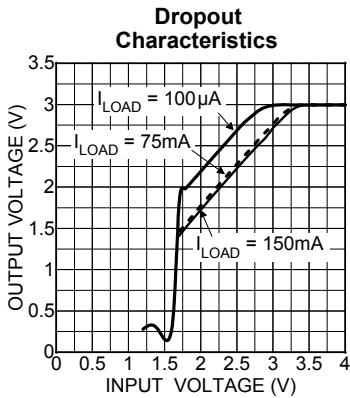
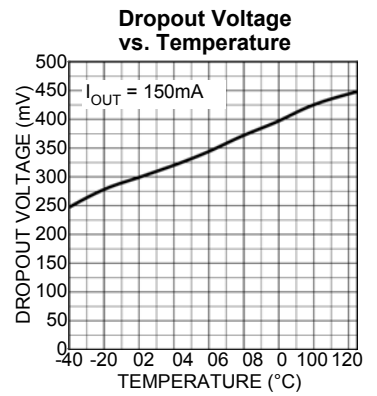
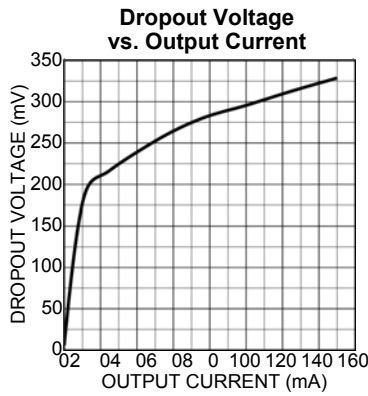
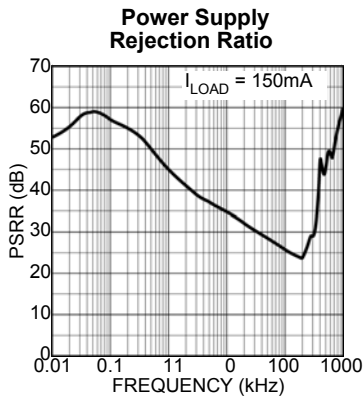

### Typical Characteristics (continued)

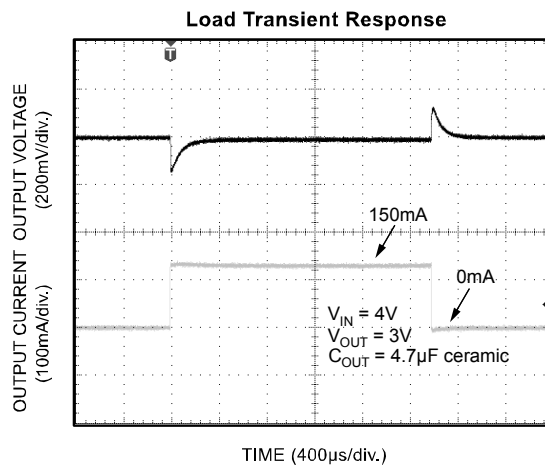
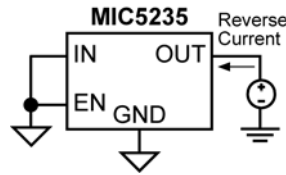
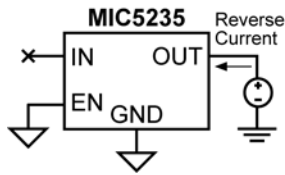
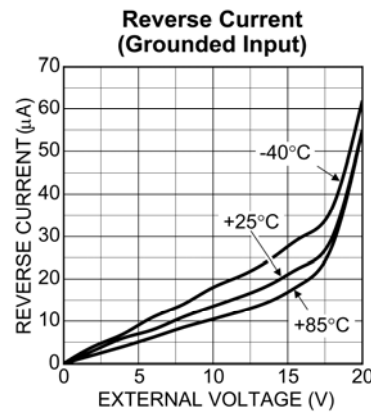
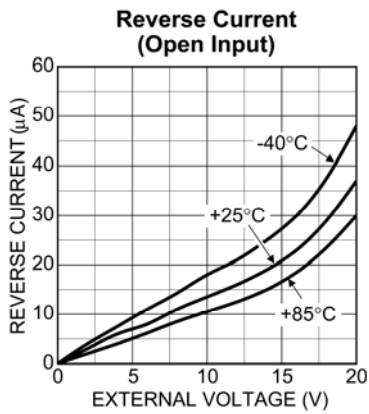
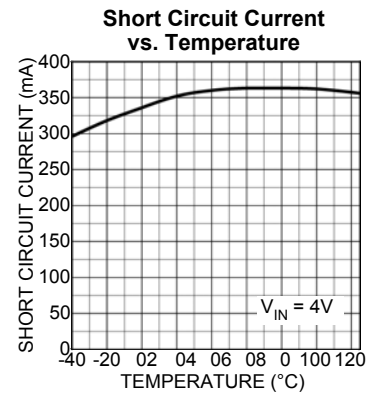
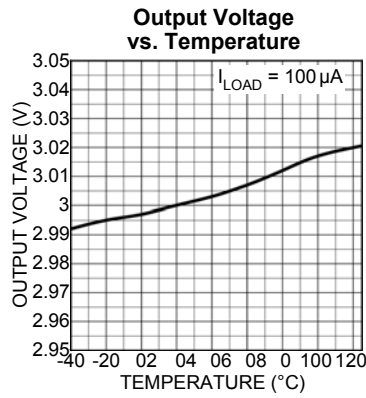
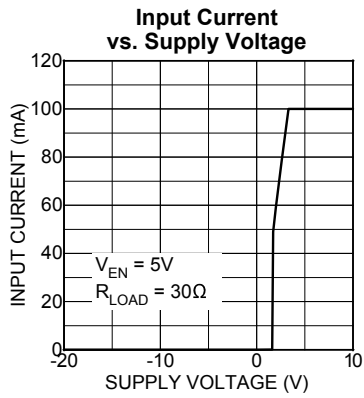

## Functional Diagram

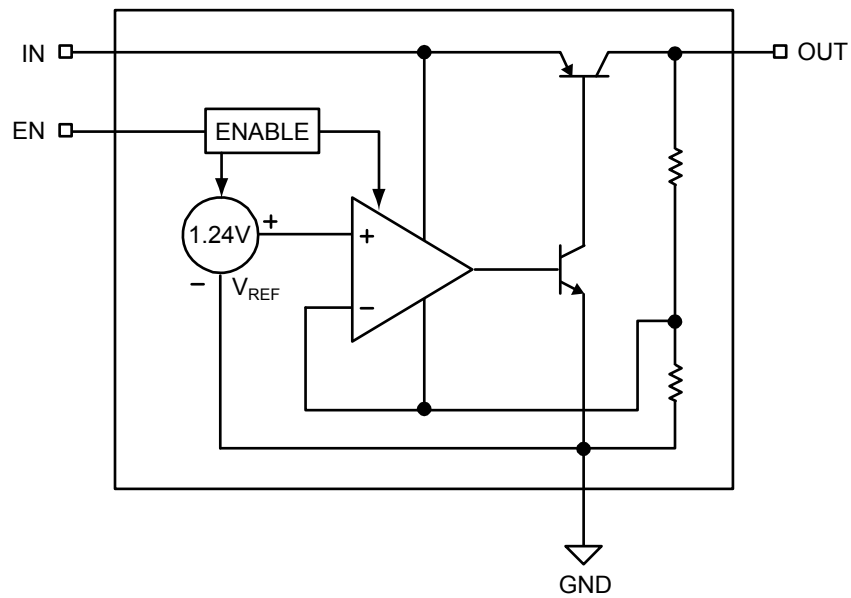

**Block Diagram – Fixed Output Voltage**

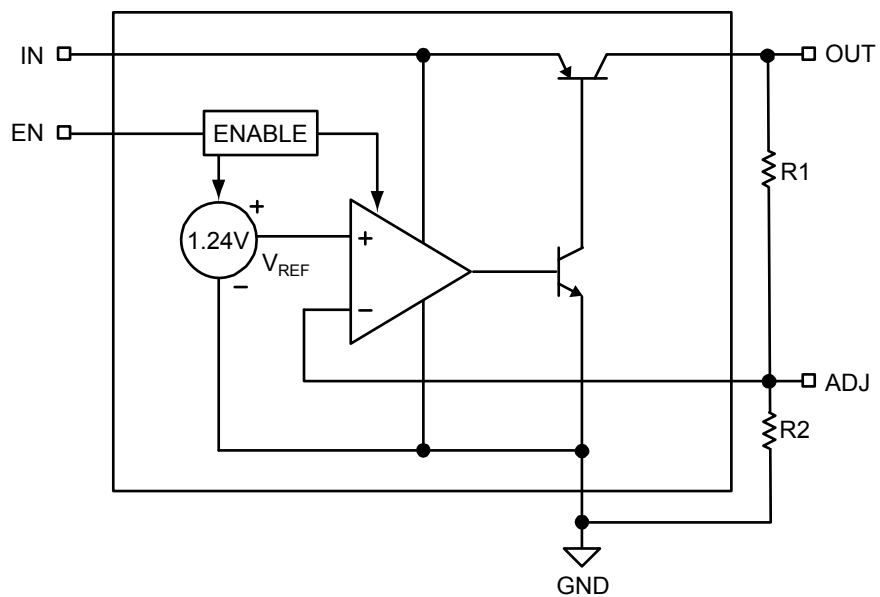

**Block Diagram – Adjustable Output Voltage**

## Application Information

### Enable/Shutdown

The MIC5235 comes with an active-high enable pin that allows the regulator to be disabled. Forcing the enable pin low disables the regulator and sends it into a “zero” off-mode-current state. In this state, current consumed by the regulator goes nearly to zero. Forcing the enable pin high enables the output voltage.

### Input Capacitor

The MIC5235 has high input voltage capability up to 24V. The input capacitor must be rated to sustain voltages that may be used on the input. An input capacitor may be required when the device is not near the source power supply or when supplied by a battery. Small, surface mount, ceramic capacitors can be used for bypassing. Larger values may be required if the source supply has high ripple.

### Output Capacitor

The MIC5235 requires an output capacitor for stability. The design requires 2.2 $\mu$ F or greater on the output to maintain stability. The design is optimized for use with low-ESR ceramic chip capacitors. High ESR capacitors may cause high frequency oscillation. The maximum recommended ESR is 3 $\Omega$ . The output capacitor can be increased without limit. Larger valued capacitors help to improve transient response.

X7R/X5R dielectric-type ceramic capacitors are recommended because of their temperature performance. X7R-type capacitors change capacitance by 15% over their operating temperature range and are the most stable type of ceramic capacitors. Z5U and Y5V dielectric capacitors change value by as much as 50% and 60% respectively over their operating temperature ranges. To use a ceramic chip capacitor with Y5V dielectric, the value must be much higher than a X7R ceramic capacitor to ensure the same minimum capacitance over the equivalent operating temperature range.

### No-Load Stability

The MIC5235 will remain stable and in regulation with no load unlike many other voltage regulators. This is especially important in CMOS RAM keep-alive applications.

### Thermal Considerations

The MIC5235 is designed to provide 150mA of continuous current in a very small package. Maximum power dissipation can be calculated based on the output current and the voltage drop across the part. To determine the maximum power dissipation of the package, use the junction-to-ambient thermal resistance of the device and the following basic equation:

$$P_{D(MAX)} = \left( \frac{T_{J(MAX)} - T_A}{\theta_{JA}} \right)$$

$T_{J(MAX)}$  is the maximum junction temperature of the die, 125°C, and  $T_A$  is the ambient operating temperature.  $\theta_{JA}$  is layout dependent; Table 1 shows examples of the junction-to-ambient thermal resistance for the MIC5235.

Package	$\theta_{JA}$ Recommended Minimum Footprint
SOT-23-5	235°C

**Table 1. SOT-23-5 Thermal Resistance**

The actual power dissipation of the regulator circuit can be determined using the equation:

$$P_D = (V_{IN} - V_{OUT})I_{OUT} + V_{IN}I_{GND}$$

Substituting  $P_{D(MAX)}$  for  $P_D$  and solving for the operating conditions that are critical to the application will give the maximum operating conditions for the regulator circuit. For example, when operating the MIC5235-3.0BM5 at 50°C with a minimum footprint layout, the maximum input voltage for a set output current can be determined as follows:

$$P_{D(MAX)} = \left( \frac{125^\circ\text{C} - 50^\circ\text{C}}{235^\circ\text{C/W}} \right)$$

$$P_{D(MAX)} = 319\text{mW}$$

The junction-to-ambient ( $\theta_{JA}$ ) thermal resistance for the minimum footprint is 235°C/W, from Table 1. It is important that the maximum power dissipation not be exceeded to ensure proper operation. Since the MIC5235 was designed to operate with high input voltages, careful consideration must be given so as not to overheat the device. With very high input-to-output voltage differentials, the output current is limited by the total power dissipation. Total power dissipation is calculated using the following equation:

$$P_D = (V_{IN} - V_{OUT})I_{OUT} + V_{IN} \times I_{GND}$$

Due to the potential for input voltages up to 24V, ground current must be taken into consideration. If we know the maximum load current, we can solve for the maximum input voltage using the maximum power dissipation calculated for a 50°C ambient, 319mW.

$$P_{D(MAX)} = (V_{IN} - V_{OUT})I_{OUT} + V_{IN} \times I_{GND}$$

$$319\text{mW} = (V_{IN} - 3\text{V})150\text{mA} + V_{IN} \times 2.8\text{mA}$$

Ground pin current is estimated using the typical characteristics of the device.

$$769\text{mW} = V_{IN} (152.8\text{mA})$$

$$V_{IN} = 5.03\text{V}$$

For higher current outputs only a lower input voltage will work for higher ambient temperatures.

Assuming a lower output current of 20mA, the maximum input voltage can be recalculated:

$$319\text{mW} = (V_{\text{IN}} - 3\text{V})20\text{mA} + V_{\text{IN}} \times 0.2\text{mA}$$

$$379\text{mW} = V_{\text{IN}} \times 20.2\text{mA}$$

$$V_{\text{IN}} = 18.8\text{V}$$

Maximum input voltage for a 20mA load current at 50°C ambient temperature is 18.8V, utilizing virtually the entire operating voltage range of the device.

### Adjustable Regulator Application

The MIC5235BM5 can be adjusted from 1.24V to 20V by using two external resistors (Figure 1). The resistors set the output voltage based on the following equation:

$$V_{\text{OUT}} = V_{\text{REF}} \left( 1 + \left( \frac{R_1}{R_2} \right) \right)$$

Where  $V_{\text{REF}} = 1.24\text{V}$ .

Feedback resistor R2 should be no larger than 300kΩ.

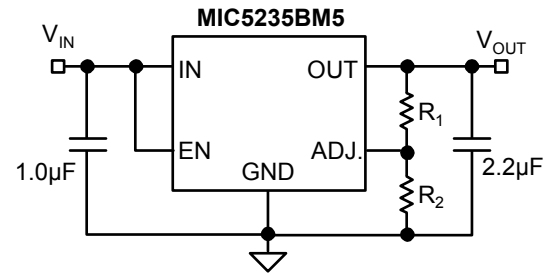
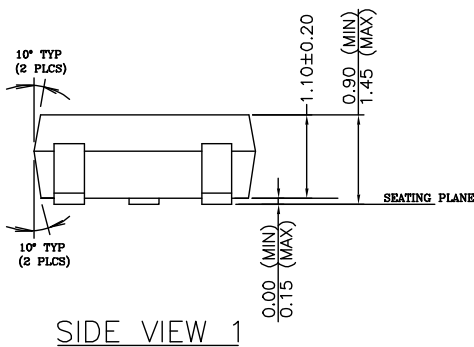
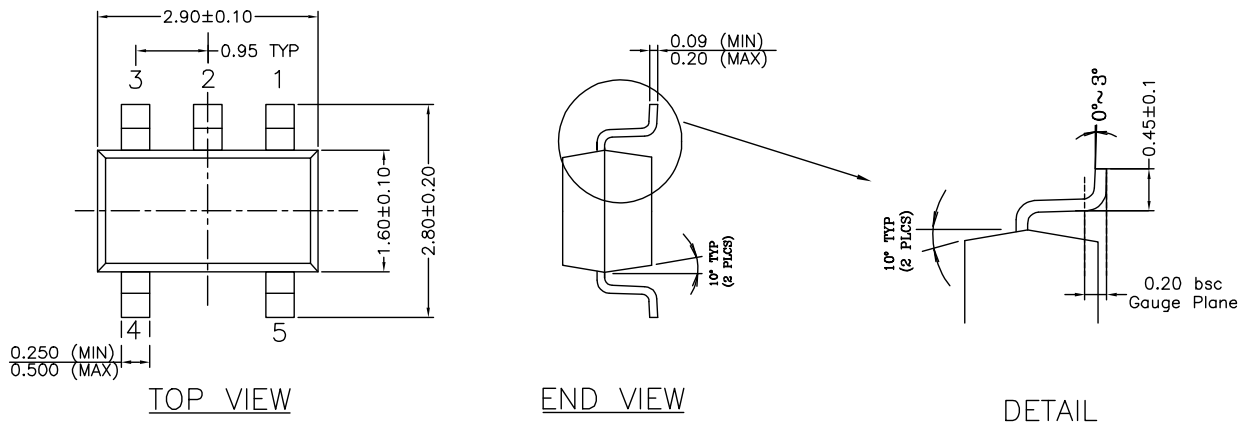

Figure 1. Adjustable Voltage Application



Package Information



- NOTE:
1. PACKAGE OUTLINE EXCLUSIVE OF MOLD FLASH & BURR.
  2. PACKAGE OUTLINE INCLUSIVE OF SOLER PLATING.
  3. DIMENSION AND TOLERANCE PER ANSI Y14.5M, 1982.
  4. FOOT LENGTH MEASUREMENT BASED ON GAUGE PLANE METHOD.
  5. DIE FACES UP FOR MOLD, AND FACES DOWN FOR TRIM/FORM.

SOT-23-5 (M5)

**MICREL, INC. 2180 FORTUNE DRIVE SAN JOSE, CA 95131 USA**  
 TEL +1 (408) 944-0800 FAX +1 (408) 774-1000 WEB <http://www.micrel.com>

The information furnished by Micrel in this data sheet is believed to be accurate and reliable. However, no responsibility is assumed by Micrel for its use. Micrel reserves the right to change circuitry and specifications at any time without notification to the customer.

Micrel Products are not designed or authorized for use as components in life support appliances, devices or systems where malfunction of a product can reasonably be expected to result in personal injury. Life support devices or systems are devices or systems that (a) are intended for surgical implant into the body or (b) support or sustain life, and whose failure to perform can be reasonably expected to result in a significant injury to the user. A Purchaser's use or sale of Micrel Products for use in life support appliances, devices or systems is a Purchaser's own risk and Purchaser agrees to fully indemnify Micrel for any damages resulting from such use or sale.

© 2003 Micrel, Incorporated.