

**DATA SHEET**  
**SE2594L: Dual Band 802.11a/b/g/n Wireless LAN Front End**

**Applications**

- IEEE802.11b DSSS WLAN
- IEEE802.11g OFDM WLAN
- IEEE802.11a OFDM WLAN
- IEEE802.11n WLAN
- Access Points, PCMCIA, PC cards

**Features**

- All RF ports matched to 50  $\Omega$
- Integrated 2.4 GHz PA, 5 GHz PA, TX Filter, T/R switches and diplexers
- Integrated Power Detector for each TX Chain
- 21 dBm O/P Power, 802.11b, 11 Mbps, ACPR = 35 dBc
- 18 dBm @ 3.0 % EVM, 802.11g, 54 Mbits
- 16.5 dBm @ 3.0 % EVM, 802.11a, 54 Mbits
- Single supply voltage: 3.3 V  $\pm$  10 %
- Lead free, Halogen free, RoHS compliant, MSL 3
- 5mm x 5mm x 0.9mm, QFN Package

**Ordering Information**

Part No.	Package	Remark
SE2594L	32 pin QFN	Samples
SE2594L-R	32 pin QFN	Tape and Reel
SE2594L-EK1	N/A	Evaluation kit

**Product Description**

The SE2594L is a complete 802.11a/b/g/n WLAN RF front-end module providing all the functionality of the power amplifiers, filtering, power detector, T/R switch, diplexers and associated matching. The SE2594L provides a complete 2.4 GHz and 5 GHz WLAN RF solution from the output of the transceiver to the antenna in an ultra compact form factor.

Designed for ease of use, all RF ports are matched to 50  $\Omega$  to simplify PCB layout and the interface to the transceiver RFIC. The SE2594L also includes a transmitter power detector for each band and transmit chain with 20 dB of dynamic range for each transmit chain. Each transmit chain has a separate digital enable control for transmitter power ramp on/off control. The power ramp rise/fall time is less than 0.7  $\mu$ sec.

The device also provides a notch filter from 3.260-3.267 GHz and 3.28-3.89 GHz prior to the input of each 2.4 GHz and 5 GHz power amplifiers, respectively.

The SE2594L packaged in 5mm x 5mm x 0.9mm, Halogen free, Lead free, ROHS compliant, MSL 3 QFN package.

**DATA SHEET**  
**SE2594L: Dual Band 802.11a/b/g/n Wireless LAN Front End**

**Functional Block Diagram**

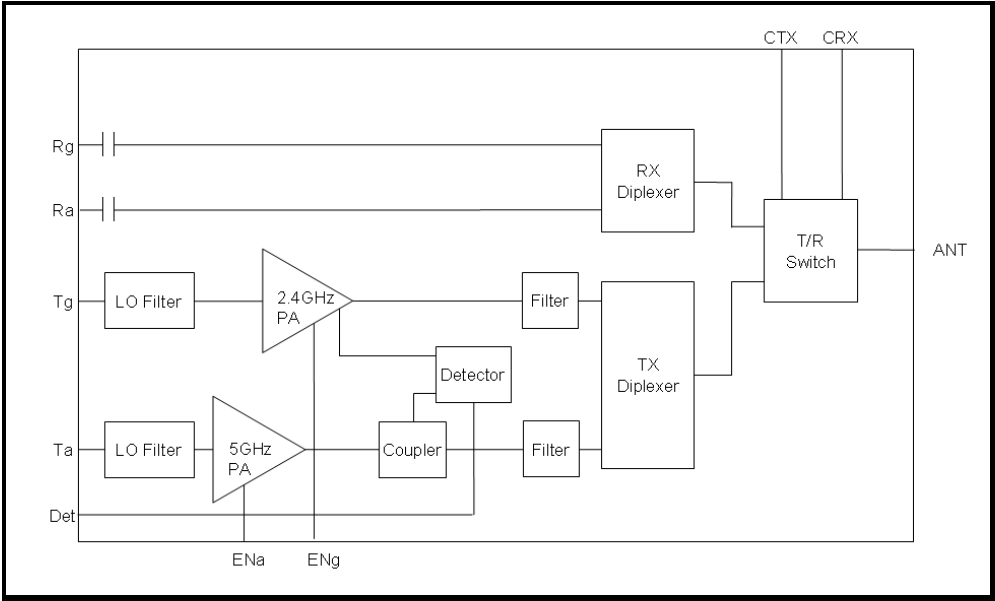

**Figure 1: SE2594L Functional Block Diagram**

**DATA SHEET**  
**SE2594L: Dual Band 802.11a/b/g/n Wireless LAN Front End**

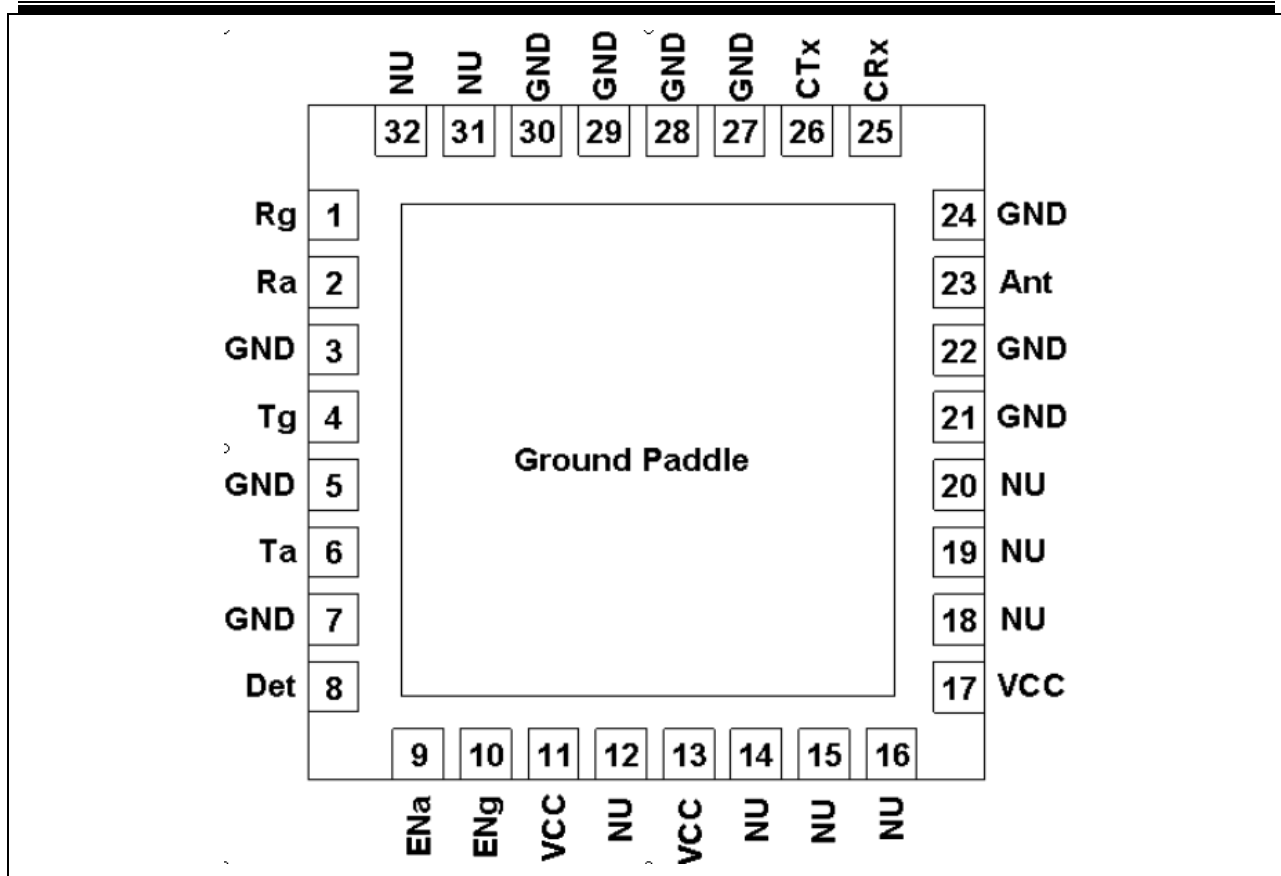

Figure 2: SE2594L Pin Out (Top View Through Package)

**Pin Out Description**

Pin No.	Name	Description
1	Rg	2.4 GHz RF Receive Output, DC blocked
2	Ra	5 GHz RF Receive Output, DC blocked
3	GND	Ground
4	Tg	2.4 GHz RF Transmit Input, DC short to GND
5	GND	Ground
6	Ta	5 GHz RF Transmit Input, DC short to GND
7	GND	Ground
8	Det	2.4/5 GHz Power Detector Output
9	ENa	5 GHz Power Amplifier Enable
10	ENg	2.4 GHz Power Amplifier Enable
11	VCC	Supply Voltage
12	NU	No Used
13	VCC	Supply Voltage
14	NU	Not Used
15	NU	Not Used

Pin No.	Name	Description
17	VCC	Supply Voltage
18	NU	Not Used
19	NU	Not Used
20	NU	Not Used
21	GND	Ground
22	GND	Ground
23	Ant	Antenna
24	GND	Ground
25	CRx	Receive Switch Control
26	CTx	Transmit Switch Control
27	GND	Ground
28	GND	Ground
29	GND	Ground
30	GND	Ground
31	NU	Not Used



**DATA SHEET**

**SE2594L: Dual Band 802.11a/b/g/n Wireless LAN Front End**

16	NU	Not Used	32	NU	Not Used
----	----	----------	----	----	----------

**Absolute Maximum Ratings**

These are stress ratings only. Exposure to stresses beyond these maximum ratings may cause permanent damage to, or affect the reliability of the device. Avoid operating the device outside the recommended operating conditions defined below. This device is ESD sensitive. Handling and assembly of this device should be at ESD protected workstations.

Symbol	Definition	Min.	Max.	Unit
V <sub>CC</sub>	Supply Voltage	-0.3	4.0	V
PU	ENa, ENg	-0.3	4.0	V
TX <sub>RF</sub>	Ta, Tg, ANT terminated in 6:1 load or better	-	12.0	dBm
T <sub>A</sub>	Operating Temperature Range	-40	85	°C
T <sub>STG</sub>	Storage Temperature Range	-40	150	°C

**Recommended Operating Conditions**

Symbol	Parameter	Min.	Typ.	Max.	Unit
V <sub>CC</sub>	Supply Voltage	3.0	3.3	3.6	V
T <sub>A</sub>	Ambient Temperature	-40	25	85	°C

**DC Electrical Characteristics**

Conditions: V<sub>CC</sub> = 3.3 V, T<sub>A</sub> = 25 °C, as measured on Skyworks Solutions' SE2594L-EV1 evaluation board (de-embedded to device), all unused ports terminated with 50 ohms, unless otherwise noted

Symbol	Parameter	Conditions	Min.	Typ.	Max.	Unit
I <sub>CC-G</sub>	Total 802.11g Transmit Supply Current	P <sub>OUT</sub> = 18 dBm, 54 Mbps OFDM signal, 64 QAM ENg = 3.3 V, ENa = 0 V	-	150	-	mA
I <sub>CC-B</sub>	Total 802.11b Transmit Supply Current	P <sub>OUT</sub> = 21 dBm, 11 Mbps CCK signal, BT = 0.45, ENg = 3.3 V, ENa = 0 V	-	180	-	mA
I <sub>CC-A</sub>	Total 802.11a Transmit Supply Current	P <sub>OUT</sub> = 16 dBm, 54 Mbps OFDM signal, 64 QAM, ENa = 3.3 V, ENg = 0 V	-	220	250	mA
I <sub>CC_OFF</sub>	Total Supply Current	No RF, ENg = ENa = 0 V	-	2	100	µA

**DATA SHEET**  
**SE2594L: Dual Band 802.11a/b/g/n Wireless LAN Front End**

**Logic Characteristics**

Conditions:  $V_{CC} = 3.3\text{ V}$ ,  $T_A = 25\text{ }^\circ\text{C}$ , as measured on Skyworks Solutions' SE2594L-EV1 evaluation board (de-embedded to device), all unused ports terminated with 50 ohms, unless otherwise noted.

Symbol	Parameter	Conditions	Min.	Typ.	Max.	Unit
$V_{ENH}$	Logic High Voltage for ENG, ENa (Module On)	-	1.8	-	$V_{CC}$	V
$V_{ENL}$	Logic Low Voltage ENG, ENa (Module Off)	-	0	-	0.5	V
$I_{ENH}$	Input Current Logic High Voltage (ENG, ENa)	-	-	350	400	$\mu\text{A}$
$I_{ENL}$	Input Current Logic Low Voltage (ENG, ENa)	-	-	0.2	-	$\mu\text{A}$

**Switch Characteristics**

Conditions:  $V_{CC} = 3.3\text{ V}$ ,  $T_A = 25\text{ }^\circ\text{C}$ , as measured on Skyworks Solutions' SE2594L-EV1 evaluation board (de-embedded to device), all unused ports terminated with 50 ohms, unless otherwise noted.

Symbol	Parameter	Conditions	Min.	Typ.	Max.	Unit
$V_{CTL\_ON}$	Control Voltage (On State)	-	3.0	-	3.6	V
$V_{CTL\_OFF}$	Control Voltage (OFF State)	-	0.0	-	0.2	V
$SW_{ON}$	Low Loss Switch Control Voltage	High State = $V_{CTL\_ON} - V_{CTL\_OFF}$	2.8	-	$V_{CC}$	V
$SW_{OFF}$	High Loss Switch Control Voltage	Low State = $V_{CTL\_OFF} - V_{CTL\_OFF}$	0	-	0.3	V
$I_{CTL\_ON}$	Switch Control Bias Current (RF Applied)	On pin (CTx, CRx) being driven high. RF Applied	-	-	100	$\mu\text{A}$
$I_{CTL\_ON}$	Switch Control Bias Current (No RF)	On pin (CTx, CRx) being driven high. No RF	-	-	30	$\mu\text{A}$
$C_{CTL}$	Control Input Capacitance	-	-	-	100	pF

**Switch Control Logic Table**

CTx	CRx	Tg, Ta – ANT	Rg, Ra – ANT
$SW_{ON}$	$SW_{OFF}$	<b>ON</b>	<b>OFF</b>
$SW_{OFF}$	$SW_{ON}$	<b>OFF</b>	<b>ON</b>
$SW_{OFF}$	$SW_{OFF}$	<b>OFF</b>	<b>OFF</b>
<b>All Other States</b>		<b>Unsupported Switch State</b>	

**DATA SHEET**

**SE2594L: Dual Band 802.11a/b/g/n Wireless LAN Front End**

**2.4 GHz AC Electrical Characteristics**

**2.4 GHz Transmit Characteristics**

Conditions:  $V_{CC} = 3.3\text{ V}$ ,  $ENg = CTx = 3.3\text{ V}$ ,  $ENa = CRx = 0\text{ V}$ ,  $T_A = 25\text{ }^\circ\text{C}$ , as measured on Skyworks Solutions' SE2594L-EV1 evaluation board, all unused ports terminated with 50 ohms, unless otherwise noted.

Symbol	Parameter	Condition	Min.	Typ.	Max.	Unit
$F_{IN}$	Frequency Range	-	2400	-	2500	MHz
$P_{802.11g}$	Output power	54 Mbps OFDM signal, 64QAM, EVM = 3.0 %	-	18	-	dBm
$P_{802.11b}$	Output power	11 Mbps CCK signal, BT = 0.45 ACPR( $\pm 11\text{MHz offset}$ ) < -35 ACPR( $\pm 22\text{MHz offset}$ ) < -55	-	21	-	dBm
$P_{1dB}$	P1dB	-	23	24	-	dBm
$S_{21}$	Small Signal Gain	-	25	-	30	dB
$\Delta S_{21}$	Small Signal Gain Variation Over Band	-	-	1.0	2.0	dB
$S_{21}1.6$	Gain at Ref-VCO $\div 2$	1600 MHz	-	-	21	dB
$S_{21}3.2$	Gain at Ref-VCO	3216.00 to 3256.00 MHz 3262.00 to 3263.21 MHz 3269.33 to 3276.00 MHz 3282.67 to 3312.00 MHz	-	-	9 4 9 17	dB
2f,3f	Harmonics	$P_{out} \leq 21\text{ dBm}$ , 1Mbps, CCK	-	-	-45.2	dBm/MHz
$t_{dr}, t_{df}$	Delay and rise/fall Time	50 % of $V_{EN}$ edge and 90/10 % of final output power level	-	-	0.4	$\mu\text{s}$
$S_{11}$	Input Return Loss	-	10	15	-	dB
STAB	Stability	CW, $P_{OUT} = 21\text{ dBm}$ 0.1 GHz – 21 GHz Load VSWR = 6:1	All non-harmonically related outputs less than -42 dBm/MHz			
$R_u$	Ruggedness	$T_g = 12\text{dBm}$ , ANT load varies over 10:1 VSWR, $ENg = 0$ or 3.3 V	No Irreversible damage			

**DATA SHEET**  
**SE2594L: Dual Band 802.11a/b/g/n Wireless LAN Front End**

**2.4 GHz Receive Characteristics**

Conditions:  $V_{CC} = 3.3\text{ V}$ ,  $CRx = 3.3\text{ V}$ ,  $ENG = ENa = CTx = 0\text{ V}$ ,  $T_A = 25\text{ }^\circ\text{C}$ , as measured on Skyworks Solutions' SE2594L-EV1 evaluation board (de-embedded to device), all unused ports terminated with 50 ohms, unless otherwise noted.

Symbol	Parameter	Condition	Min.	Typ.	Max.	Unit
F <sub>OUT</sub>	Frequency Range	-	2400	-	2500	MHz
RX <sub>IL</sub>	Insertion Loss	-	-	1.5	1.9	dB
RX <sub>RL</sub>	Return Loss	-	10	15	-	dB
TR <sub>ISOL-2</sub>	Rx Leakage	CTx = SWON, CRx = SWOFF, Device transmitting (ENG = 3.3 V) 18.0 dBm @ ANT, Power measured @ RX_OUT	-	-	0	dBm
ANTR <sub>ISOL</sub>	Antenna to Rx isolation	Small signal input into ANT, Device not transmitting, Power measured @ Rg, CTx (Ant to Rx Iso) = SWON, CRx = SWOFF	18	-	28	dB

**DATA SHEET**  
**SE2594L: Dual Band 802.11a/b/g/n Wireless LAN Front End**

**5 GHz AC Electrical Characteristics**

**5 GHz Transmit Characteristics**

Conditions:  $V_{CC} = 3.3\text{ V}$ ,  $E_{Na}$  and  $CTx = 3.3\text{ V}$ ,  $E_{Ng} = CRx = 0\text{ V}$ ,  $T_A = 25\text{ }^\circ\text{C}$ , as measured on Skyworks Solutions' SE2594L-EV1 evaluation board, all unused ports terminated with 50 ohms, unless otherwise noted.

Symbol	Parameter	Condition	Min.	Typ.	Max.	Unit
$F_{IN}$	Frequency Range	-	4900	-	5875	MHz
$P_{802.11a}$	Nominal Output Power	54 Mbps OFDM signal, 64 QAM, EVM = 3.0 %	-	16.5	-	dBm
$P_{1dB}$	P1dB	-	21	22.5	-	dBm
$S_{21}$	Small Signal Gain	-	23	-	30	dB
$\Delta S_{21}$	Small Signal Gain Variation Over 40 MHz Channel		-	-	0.5	dB
	Small Signal Gain Variation Over sub-bands	4.9 – 5.1 GHz 5.15 – 5.7 GHz 5.7 – 5.85 GHz	-	1	3	dB
$S_{21.9}$	Gain at Ref-VCO $\div 2$	1942 MHz	-	-	14	dB
$S_{213.2}$	Gain at Ref-VCO	3200 to 3900 MHz	-	-	5.5	dB
2f,3f	Harmonics @16dBm, 54Mbps, 802.11a	4900 – 5850 MHz	-	-	-48.2	dBm/MHz
$t_{dr}, t_{df}$	Delay and rise/fall Time	50 % of $V_{EN}$ edge and 90/10 % of final output power level	-	-	0.4	$\mu\text{s}$
$S_{11}$	Input Return Loss	-	-	6	-	dB
STAB	Stability	64 QAM, $P_{OUT} = 16\text{ dBm}$ 0.1 GHz – 21 GHz Load VSWR = 6:1	All non-harmonically related outputs less than -42 dBm/MHz			
$R_u$	Ruggedness	$TXa = 12\text{ dBm}$ , ANT load varies over 10:1 VSWR, $E_{Na} = 0$ or 3.3 V	No Irreversible damage			



**DATA SHEET**  
**SE2594L: Dual Band 802.11a/b/g/n Wireless LAN Front End**

**5 GHz Receive Characteristics**

Conditions:  $V_{CC} = 3.3\text{ V}$ ,  $CR_X = 3.3\text{ V}$ ,  $EN_G = EN_A = CT_X = 0\text{ V}$ ,  $T_A = 25\text{ }^\circ\text{C}$ , as measured on Skyworks Solutions' SE2594L-EV1 evaluation board (de-embedded to device), all unused ports terminated with 50 ohms, unless otherwise noted.

Symbol	Parameter	Condition	Min.	Typ.	Max.	Unit
F <sub>OUT</sub>	Frequency Range	-	4900	-	5875	MHz
RX <sub>IL</sub>	Insertion Loss	-	-	2	2.5	dB
RX <sub>RL</sub>	Return Loss	-	10	15	-	dB
TA <sub>LEAK</sub>	Tx Power Leakage	Pout = 16 dBm, ENa = 3.3 V, CTx = 3.3 V, CRx = 0 V	-	-	0	dBm
ATTa	Antenna to Rx isolation	Small signal input into ANT, Device not transmitting, Power measured @ RX <sub>RF</sub> , CTx (Ant to Rx Iso) = SWON, CRx = SWOFF	16	-	27	dB

**DATA SHEET**  
**SE2594L: Dual Band 802.11a/b/g/n Wireless LAN Front End**

**2.4 GHz Power Detector Characteristic**

Conditions:  $V_{CC} = E_{NG} = C_{TX} = 3.3\text{ V}$ ,  $C_{RX} = 0\text{ V}$ ,  $T_A = 25\text{ }^\circ\text{C}$ , as measured on Skyworks Solutions' SE2594L-EV1 evaluation board (de-embedded to device), all unused ports terminated with  $50\ \Omega$ , unless otherwise noted.

Symbol	Parameter	Condition	Min.	Typ.	Max.	Unit
F <sub>OUT</sub>	Frequency Range	-	2400	-	2500	MHz
PDR	Power detect range, peak power	Measured at ANT	0	-	22	dBm
PDZ <sub>OUT</sub>	DC Output impedance	-	-	2400	-	$\Omega$
PDV <sub>P21</sub>	Output Voltage, P <sub>OUT</sub> = 21dBm	-	-	0.85	-	V
PDV <sub>P18</sub>	Output Voltage, P <sub>OUT</sub> = 18dBm	-	-	0.68	-	V
PDV <sub>pnoRF</sub>	Output Voltage, P <sub>OUT</sub> = No RF	-	-	0.30	-	V
LPF <sub>-3dB</sub>	Power detect low pass filter -3dB corner frequency	Load = high impedance Typ: 1 M $\Omega$	-	1500	-	KHz

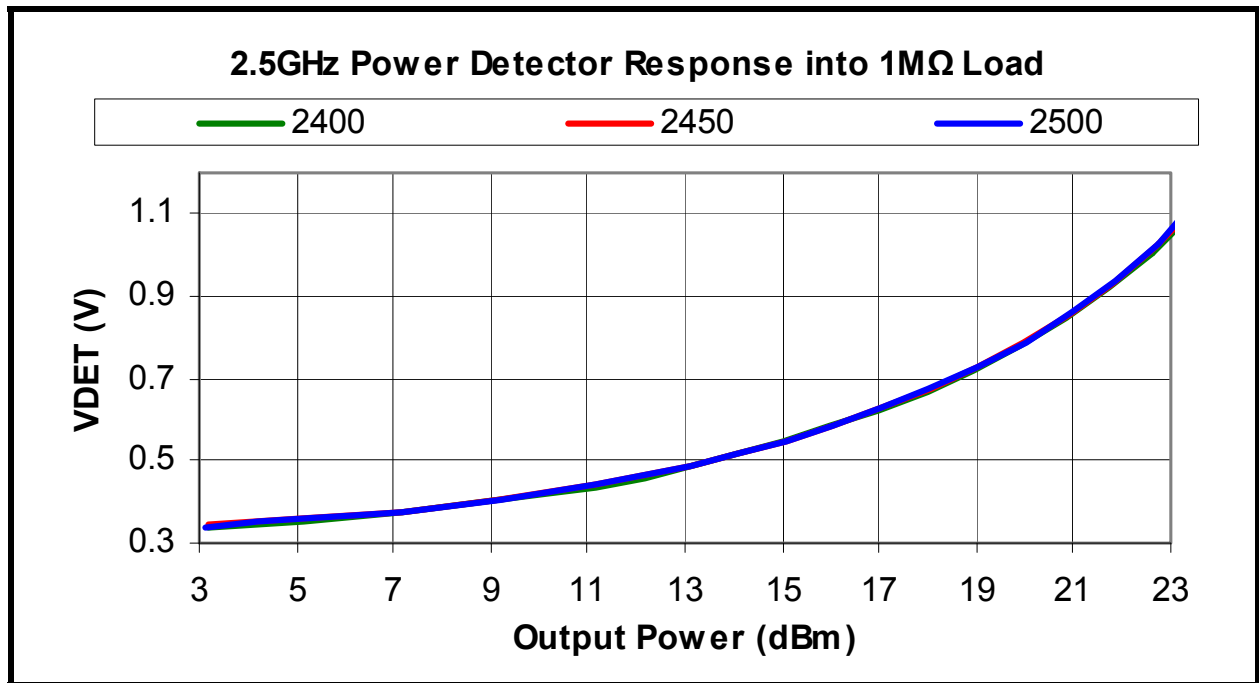

Figure 3: SE2594L Power Detector vs. Output Power over Frequency (CW Signal)

**DATA SHEET**  
**SE2594L: Dual Band 802.11a/b/g/n Wireless LAN Front End**

**5 GHz Power Detector Characteristic**

Conditions:  $V_{CC} = E_{Na} = C_{Tx} = 3.3\text{ V}$ ,  $C_{Rx} = 0\text{ V}$ ,  $T_A = 25\text{ }^\circ\text{C}$ , as measured on Skyworks Solutions' SE2594L-EV1 evaluation board (de-embedded to device), all unused ports terminated with  $50\ \Omega$ , unless otherwise noted.

Symbol	Parameter	Condition	Min.	Typ.	Max.	Unit
F <sub>OUT</sub>	Frequency Range	-	4900	-	5850	MHz
PDR	Power detect range, peak power	Measured at ANT	0	-	21	dBm
PDZ <sub>OUT</sub>	DC Output impedance	-	-	2400	-	$\Omega$
PDV <sub>p18</sub>	Output Voltage, P <sub>OUT</sub> = 18dBm	-	-	0.80	-	V
PDV <sub>p16</sub>	Output Voltage, P <sub>OUT</sub> = 16dBm	-	-	0.70	-	V
PDV <sub>NoRF</sub>	Output Voltage, P <sub>OUT</sub> = No RF	-	-	0.30	-	V
LPF <sub>-3dB</sub>	Power detect low pass filter -3dB corner frequency	Load = high impedance Typ: 1 M $\Omega$	-	1500	-	KHz

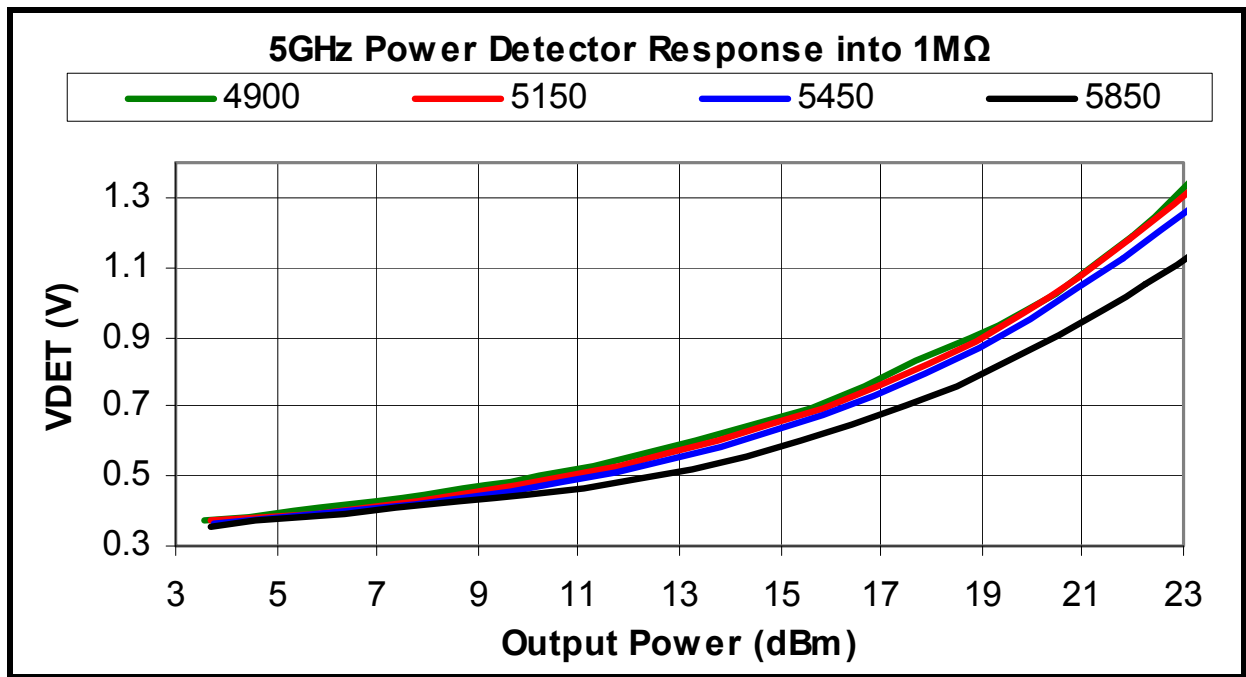

**Figure 4: Preliminary SE2594L Power Detector vs. Output Power over Frequency (CW Signal)**

**DATA SHEET**  
**SE2594L: Dual Band 802.11a/b/g/n Wireless LAN Front End**

**Package Drawing**

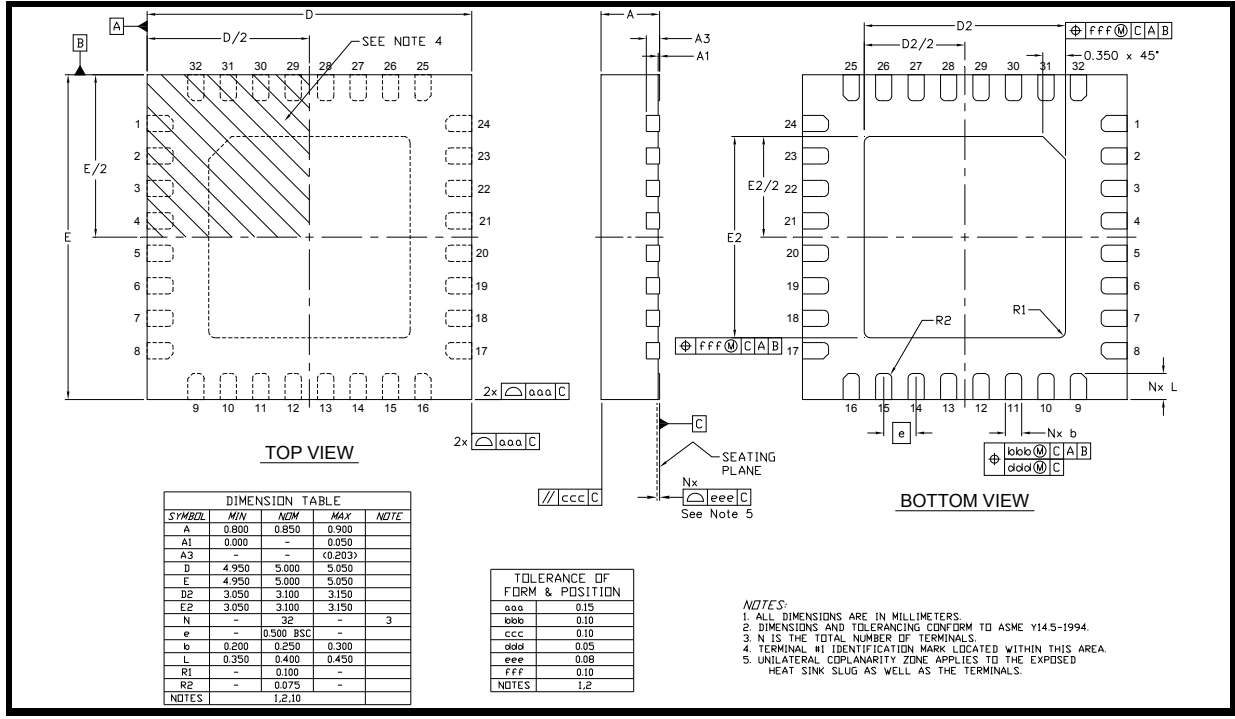

**Figure 5: Package Drawing: Topside**

**DATA SHEET**  
**SE2594L: Dual Band 802.11a/b/g/n Wireless LAN Front End**

**Recommended Land and Solder Patterns**

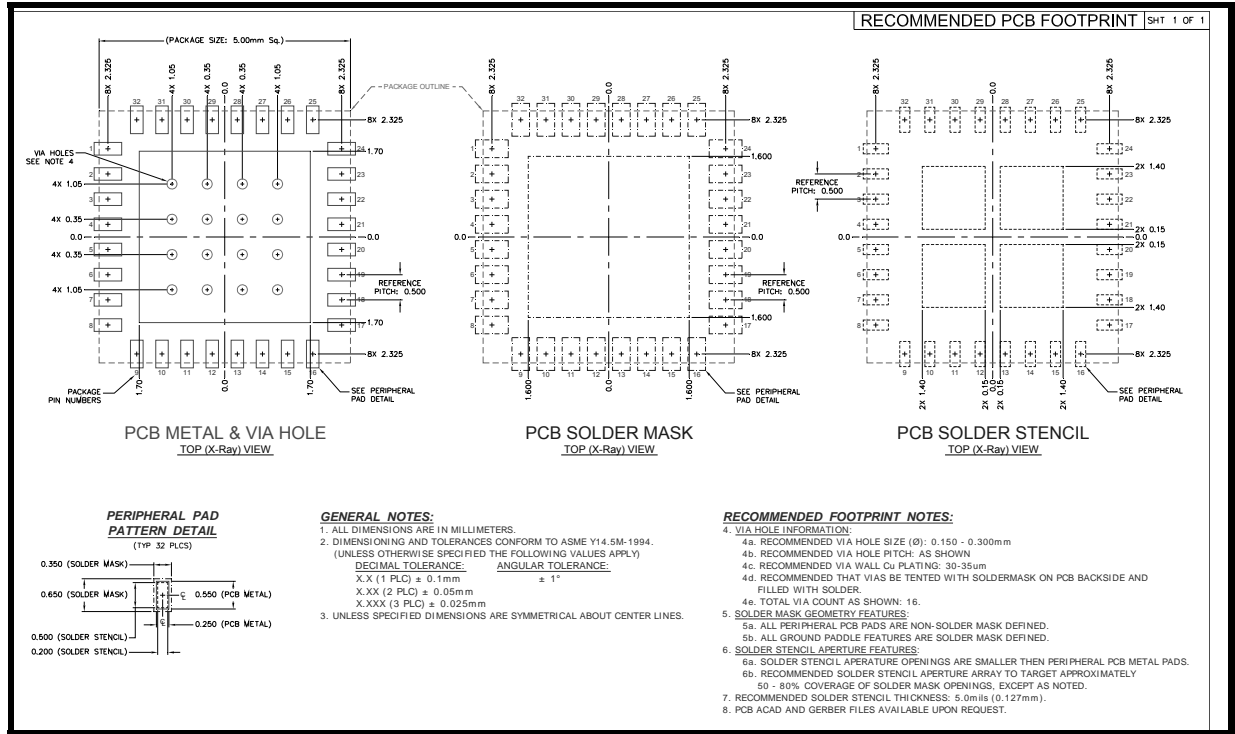

**Figure 6: Recommended Land and Solder Patterns**

**DATA SHEET**  
**SE2594L: Dual Band 802.11a/b/g/n Wireless LAN Front End**

---

**Package Handling Information**

Because of its sensitivity to moisture absorption, instructions on the shipping container label must be followed regarding exposure to moisture after the container seal is broken, otherwise, problems related to moisture absorption may occur when the part is subjected to high temperature during solder assembly. The SE2594L is capable of withstanding a Pb free solder reflow. Care must be taken when attaching this product, whether it is done manually or in a production solder reflow environment. If the part is manually attached, precaution should be taken to insure that the device is not subjected to temperatures above its rated peak temperature for an extended period of time. For details on both attachment techniques, precautions, and handling procedures recommended, please refer to:

- “Quad Flat No-Lead Module Solder Reflow & Rework Information”, *Document Number QAD-00045*
- “Handling, Packing, Shipping and Use of Moisture Sensitive QFN”, *Document Number QAD-00044*



Caution! Class 0 ESD sensitive device

**Product Branding**

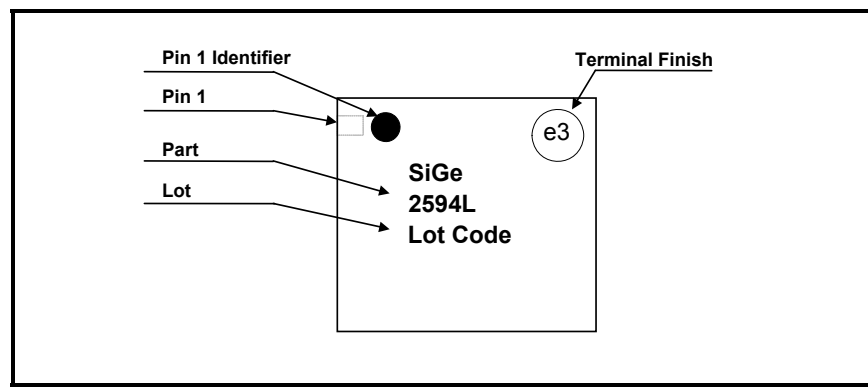

**Figure 7: SE2594L Branding Information**

**DATA SHEET**  
**SE2594L: Dual Band 802.11a/b/g/n Wireless LAN Front End**

**Tape and Reel Information**

Production quantities of this product are shipped in a standard tape-and-reel format. Specific tape and reel dimensions and sizing is shown in Table 1 and Figure .

Parameter	Value
Devices Per Reel	3000
Reel Diameter	13 inches

**Table 1: Tape and Reel Dimensions**

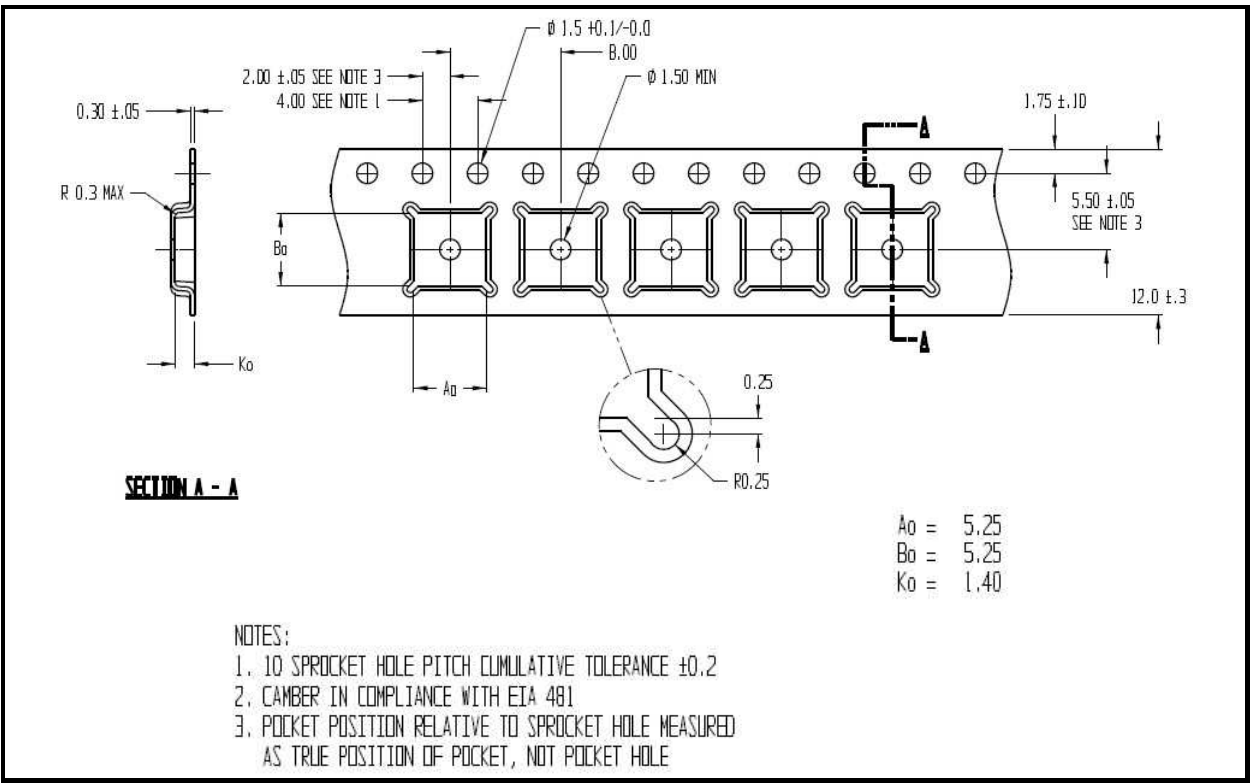

**Figure 8: Detailed Tape and Reel Information (All dimensions in Millimeters)**



**DATA SHEET**  
**SE2594L: Dual Band 802.11a/b/g/n Wireless LAN Front End**

**Document Change History**

Revision	Date	Notes
1.0	Aug-20-2008	Created
1.1	Apr-9-2009	Added VCC to Pin 13 Corrected terminal finish indicator in Branding Information
1.2	Dec-8-2009	Updated per Design Validation Test.
1.3	Jan-11-2010	Updated ICC_OFF specification
1.4	Feb-11-2011	Updated for Industrial temperature range
1.5	Jun-30-2011	Corrected Recommended Operating Condition to Industrial Temperature Range
1.6	Mar-20-2012	Corrected top marking terminal finish
1.7	Mar-28-2012	Updated with Skyworks logo and disclaimer statement

Copyright © 2012 Skyworks Solutions, Inc. All Rights Reserved.

Information in this document is provided in connection with Skyworks Solutions, Inc. ("Skyworks") products or services. These materials, including the information contained herein, are provided by Skyworks as a service to its customers and may be used for informational purposes only by the customer. Skyworks assumes no responsibility for errors or omissions in these materials or the information contained herein. Skyworks may change its documentation, products, services, specifications or product descriptions at any time, without notice. Skyworks makes no commitment to update the materials or information and shall have no responsibility whatsoever for conflicts, incompatibilities, or other difficulties arising from any future changes.

No license, whether express, implied, by estoppel or otherwise, is granted to any intellectual property rights by this document. Skyworks assumes no liability for any materials, products or information provided hereunder, including the sale, distribution, reproduction or use of Skyworks products, information or materials, except as may be provided in Skyworks Terms and Conditions of Sale.

THE MATERIALS, PRODUCTS AND INFORMATION ARE PROVIDED "AS IS" WITHOUT WARRANTY OF ANY KIND, WHETHER EXPRESS, IMPLIED, STATUTORY, OR OTHERWISE, INCLUDING FITNESS FOR A PARTICULAR PURPOSE OR USE, MERCHANTABILITY, PERFORMANCE, QUALITY OR NON-INFRINGEMENT OF ANY INTELLECTUAL PROPERTY RIGHT; ALL SUCH WARRANTIES ARE HEREBY EXPRESSLY DISCLAIMED. SKYWORKS DOES NOT WARRANT THE ACCURACY OR COMPLETENESS OF THE INFORMATION, TEXT, GRAPHICS OR OTHER ITEMS CONTAINED WITHIN THESE MATERIALS. SKYWORKS SHALL NOT BE LIABLE FOR ANY DAMAGES, INCLUDING BUT NOT LIMITED TO ANY SPECIAL, INDIRECT, INCIDENTAL, STATUTORY, OR CONSEQUENTIAL DAMAGES, INCLUDING WITHOUT LIMITATION, LOST REVENUES OR LOST PROFITS THAT MAY RESULT FROM THE USE OF THE MATERIALS OR INFORMATION, WHETHER OR NOT THE RECIPIENT OF MATERIALS HAS BEEN ADVISED OF THE POSSIBILITY OF SUCH DAMAGE.

Skyworks products are not intended for use in medical, lifesaving or life-sustaining applications, or other equipment in which the failure of the Skyworks products could lead to personal injury, death, physical or environmental damage. Skyworks customers using or selling Skyworks products for use in such applications do so at their own risk and agree to fully indemnify Skyworks for any damages resulting from such improper use or sale.

Customers are responsible for their products and applications using Skyworks products, which may deviate from published specifications as a result of design defects, errors, or operation of products outside of published parameters or design specifications. Customers should include design and operating safeguards to minimize these and other risks. Skyworks assumes no liability for applications assistance, customer product design, or damage to any equipment resulting from the use of Skyworks products outside of stated published specifications or parameters.

Skyworks, the Skyworks symbol, and "Breakthrough Simplicity" are trademarks or registered trademarks of Skyworks Solutions, Inc., in the United States and other countries. Third-party brands and names are for identification purposes only, and are the property of their respective owners. Additional information, including relevant terms and conditions, posted at [www.skyworksinc.com](http://www.skyworksinc.com), are incorporated by reference.