

DATA SHEET
SE2601T: 2.4 GHz WLAN Switch/LNA Front End

Applications

- IEEE802.11b DSSS WLAN
- IEEE802.11g,n OFDM WLAN
- Embedded applications

Product Description

The SE2601T is a single chip integrated front-end with a Bluetooth port to complement WLAN chipsets with integrated Power Amplifier. The Front-end integrates SP3T Switch and Low Noise Amplifier with bypass mode in an ultra compact package. It is capable of switching between WLAN RX, WLAN TX and Bluetooth™

Features

- ❑ Integrates SP3T Switch and LNA with by-pass mode
- ❑ 12 dB gain,
- ❑ 1.8 dB NF
- ❑ 0.7 dB Bluetooth path loss
- ❑ 2x2x 0.6mm, QFN Package, MSL 1
- ❑ Lead free, Halogen free and RoHS compliant

Ordering Information

Part No.	Package	Remark
SE2601T	QFN	Samples
SE2601T-R	QFN	Tape and Reel
SE2601T-EK1	N/A	Evaluation kit

Functional Block Diagram

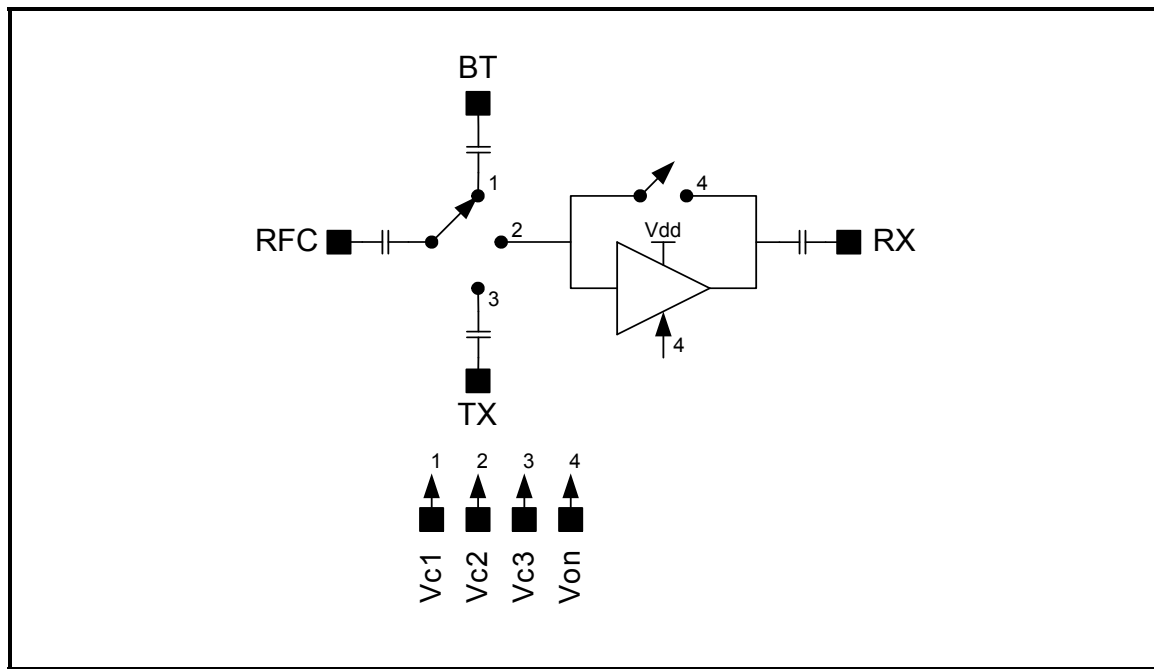
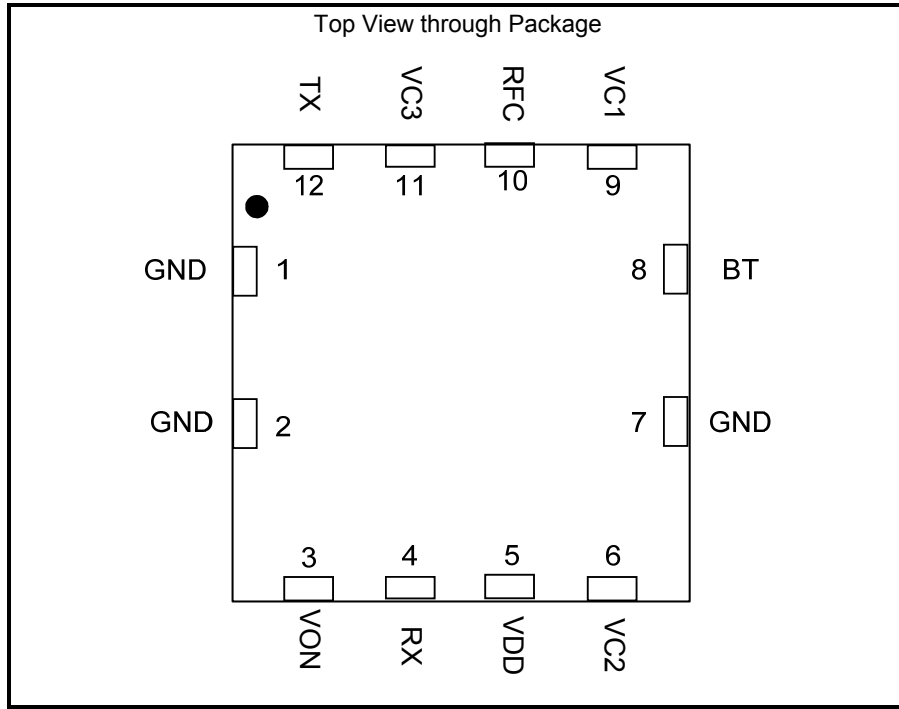

Figure 1: Functional Block Diagram

DATA SHEET
SE2601T: 2.4 GHz WLAN Switch/LNA Front End



Pin Out Description

Pad	Label	Function
1	GND	Ground
2	GND	Ground
3	Von	LNA control pin
4	RX	WLAN Receive port
5	VDD	Positive power supply voltage
6	Vc2	RX switch control pin
7	GND	Ground
8	BT	Bluetooth port
9	Vc1	BT switch control pin
10	RFC	RF Common (antenna port)
11	VC3	TX switch control pin
12	TX	WLAN Transmit port

DATA SHEET
SE2601T: 2.4 GHz WLAN Switch/LNA Front End

Absolute Maximum Ratings

These are stress ratings only. Exposure to stresses beyond these maximum ratings may cause permanent damage to, or affect the reliability of the device. Avoid operating the device outside the recommended operating conditions defined below. This device is ESD sensitive. Handling and assembly of this device should be at ESD protected workstations.

Symbol	Definition	Min.	Max.	Unit
V _{dd}	Supply Voltage on V _{dd}	0	3.6	V
V _{ON, cc}	DC input on control pins	-0.5	V _{dd} +0.5	V
P _{TXIN}	TX Input Power, ANT terminated in 50Ω match	-	27	dBm
T _A	Operating Temperature Range	-40	85	°C
T _{STG}	Storage Temperature Range	-40	150	°C
ESD _{HBM}	JEDEC JESD22-A114 all pins	1000		V

Recommended Operating Conditions

Symbol	Parameter	Min.	Typ.	Max.	Unit
T _A	Ambient temperature	-40	25	85	°C
V _{dd}	Supply voltage, relative to GND = 0 V	2.7	3.3	3.6	V
V _{ON, cc}	Control voltage, relative to GND = 0 V	0	-	V _{dd}	V

DC Electrical Characteristics

Conditions: V_{dd} = 3.3 V, T_A = 25 °C, as measured on Skyworks SE2601T EK1 evaluation board (de-embedded to device), all unused ports terminated with 50 ohms, unless otherwise noted

Symbol	Parameter	Conditions	Min.	Typ.	Max.	Unit
I _{dd}	LNA current	Gain mode	-	10	13	mA
I _{dd}	LNA current	Bypass mode			60	μA
I _{ON}	LNA control current		-		20	μA
I _{c1}	BT port control current		-		20	μA
I _{c3}	TX port control current		-		20	μA
V _{IH}	Logic input high		2.7		3.6	V
V _{IL}	Logic input low		0		0.3	V

DATA SHEET
SE2601T: 2.4 GHz WLAN Switch/LNA Front End

Control Logic Table

Mode#	Mode Description	Vc1	Vc2	Vc3	Von
0	All Off	0	0	0	0
1	Tx	0	0	1	0
2	BT	1	0	0	0
3	Rx – high gain	0	1	0	1
4	Rx - bypass	0	1	0	0

AC Electrical Characteristics

Transmit Characteristics (RFC-TX port)

Conditions: $V_{dd} = 3.3\text{ V}$, $T_A = 25\text{ }^\circ\text{C}$, as measured on Skyworks Solutions' SE2601T EK1 evaluation board (de-embedded to device), all unused ports terminated with 50 ohms, unless otherwise noted. $V_{c1} = V_{c2} = V_{on} = 0$.

Symbol	Parameter	Condition	Min.	Typ.	Max.	Unit
F_{OUT}	Frequency Range	-	2400	-	2500	MHz
TX_{IL}	Insertion Loss		-	0.7	0.9	dB
S_{11}	Input Return Loss			-16	-13	dB
S_{22}	Output Return Loss			-16	-13	dB
$ISOL_{SW}$	Switch Isolation	$V_{c3} = 0$	23			dB
IP1dB	Input P1dB		31			dBm

Bluetooth Characteristics (RFC-BT port)

Conditions: $V_{dd} = 3.3\text{ V}$, $T_A = 25\text{ }^\circ\text{C}$, as measured on Skyworks Solutions' SE2601T EK1 evaluation board (de-embedded to device), all unused ports terminated with 50 ohms, unless otherwise noted. $V_{c2} = V_{c3} = V_{on} = 0$.

Symbol	Parameter	Condition	Min.	Typ.	Max.	Unit
F_{OUT}	Frequency Range	-	2400	-	2500	MHz
BT_{IL}	Insertion Loss		-	0.7	0.9	dB
S_{11}	BT Port Return Loss			-16	-14	dB
S_{22}	BT Port Return Loss			-16	-14	dB
IP1dB	Input P1dB		31			dBm
$ISOL_{SW}$	Switch Isolation	$V_{c1} = 0$	25			dB

DATA SHEET
SE2601T: 2.4 GHz WLAN Switch/LNA Front End

Receive Characteristics (RF- RX port)

Conditions: $V_{dd} = 3.3\text{ V}$, $T_A = 25\text{ }^\circ\text{C}$, as measured on Skyworks Solutions' SE2601T EK1 evaluation board (de-embedded to device), all unused ports terminated with 50 ohms, unless otherwise noted. $V_{c1} = V_{c3} = 0$.

Symbol	Parameter	Condition	Min.	Typ.	Max.	Unit
F_{OUT}	Frequency Range	-	2400	-	2500	MHz
S_{21}	Receive Gain, LNA enabled.		11	12	13	dB
NF	Noise Figure		-	1.8	2.0	dB
S_{11}	Input Return Loss			-10	-8	dB
S_{22}	Output Return Loss			-10	-8	dB
IP1dB	Input P1dB		-7	-6		dBm
S_{21-BYP}	Receive Gain, LNA bypassed		-4	-3		dB

DATA SHEET
SE2601T: 2.4 GHz WLAN Switch/LNA Front End

Package Handling Information

Branding Information

The device branding is shown in Figure 4.

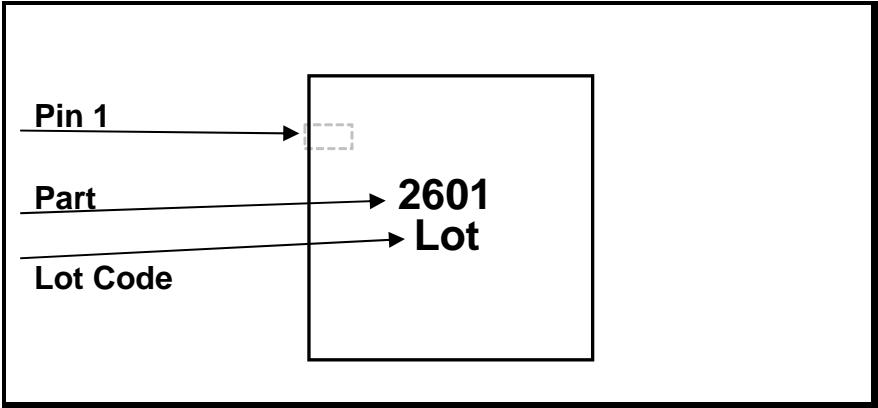

Figure 4: SE2601T Branding and Pin 1 Location

Package Diagram

The package diagram is shown in Figure 5.

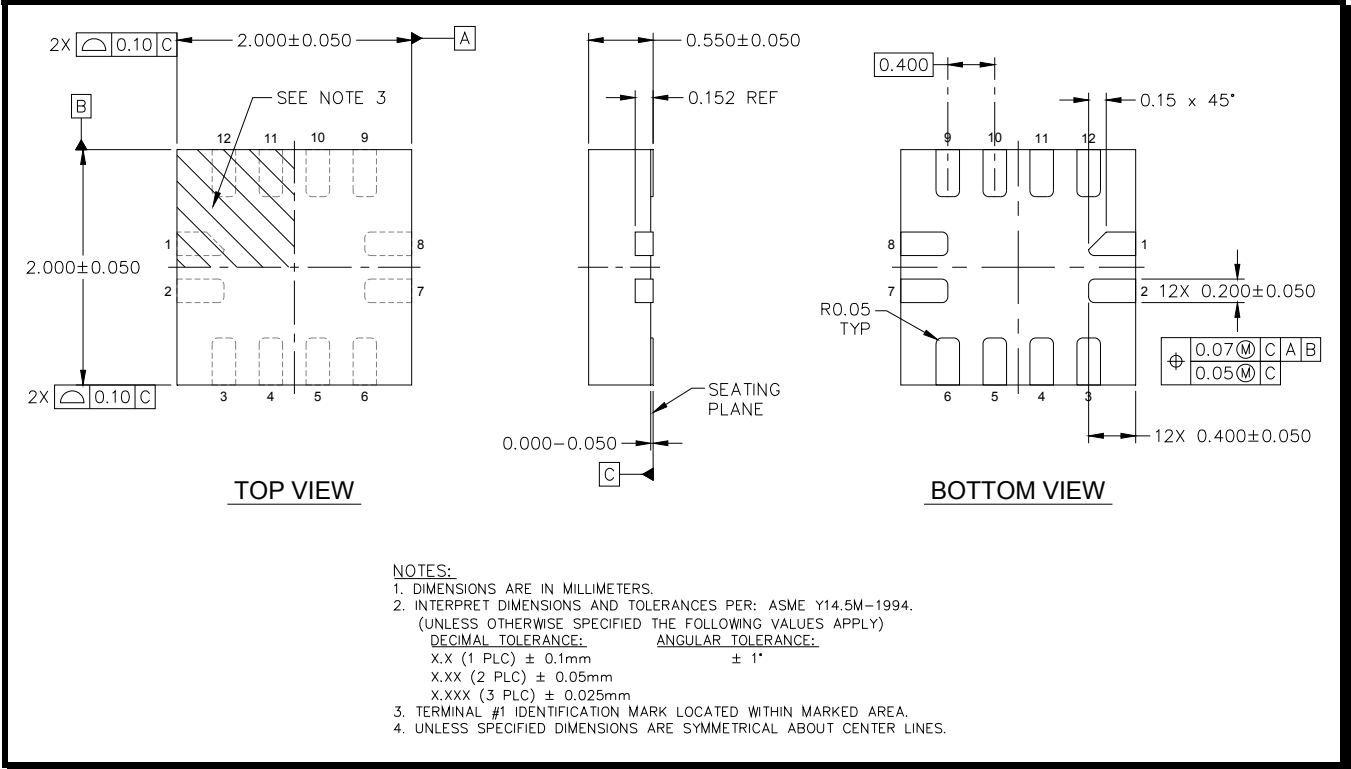

Figure 5: SE2601T Package Diagram

DATA SHEET
SE2601T: 2.4 GHz WLAN Switch/LNA Front End

Recommended PCB Footprint Recommendations

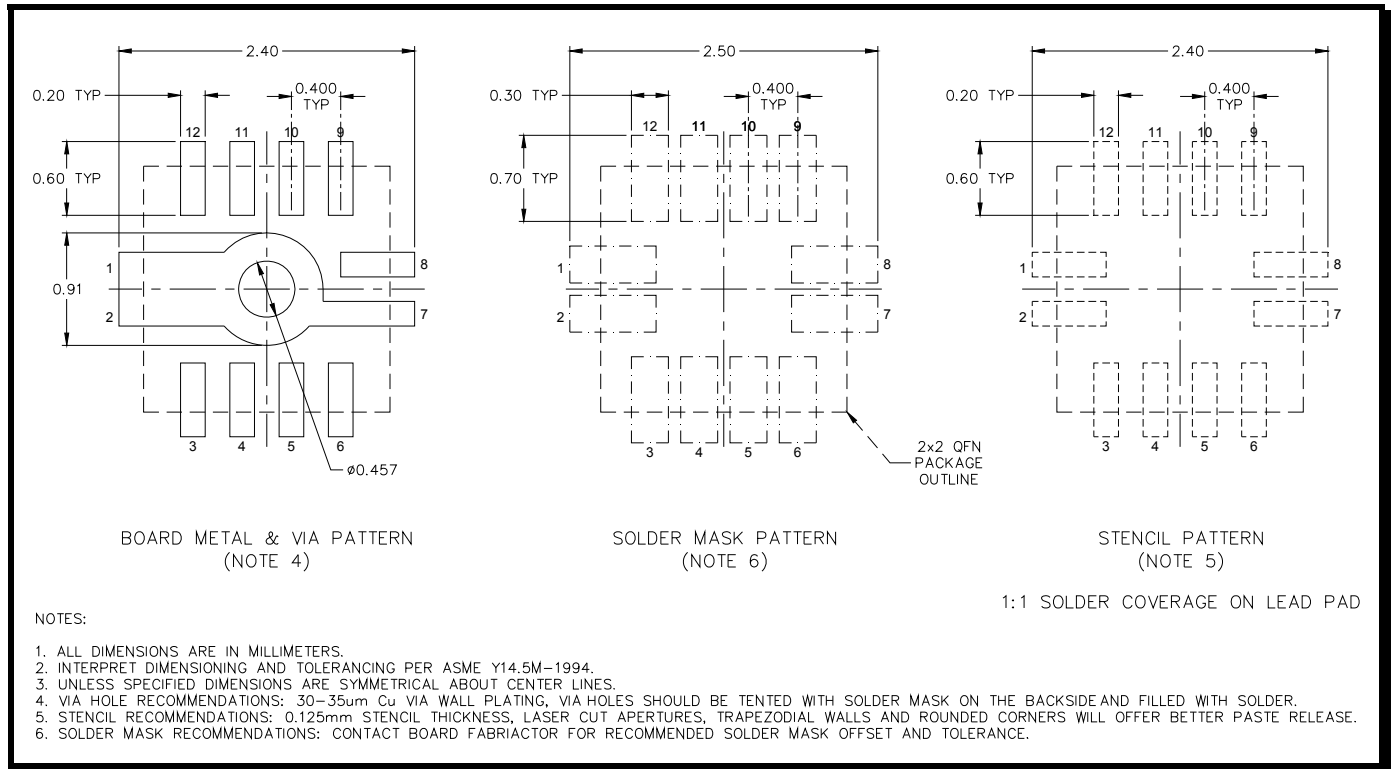

Figure 6: SE2601T PCB Footprint Recommendations

Package Handling Information

Because of its sensitivity to moisture absorption, instructions on the shipping container label must be followed regarding exposure to moisture after the container seal is broken, otherwise, problems related to moisture absorption may occur when the part is subjected to high temperature during solder assembly. The SE2601T is capable of withstanding a Pb free solder reflow. Care must be taken when attaching this product, whether it is done manually or in a production solder reflow environment. If the part is manually attached, precaution should be taken to insure that the device is not subjected to temperatures above its rated peak temperature for an extended period of time. For details on both attachment techniques, precautions, and handling procedures recommended, please refer to:

- “QFN solder reflow and rework information application note”, Document Number QAD-00045
- “Handling, packing, shipping and use of moisture sensitive QFN application note”, Document Number QAD-00044

DATA SHEET
SE2601T: 2.4 GHz WLAN Switch/LNA Front End

Tape and Reel Specification

Parameter	Value
Devices Per Reel	3000
Reel Diameter	7 inches
Tape Width	8 millimeters

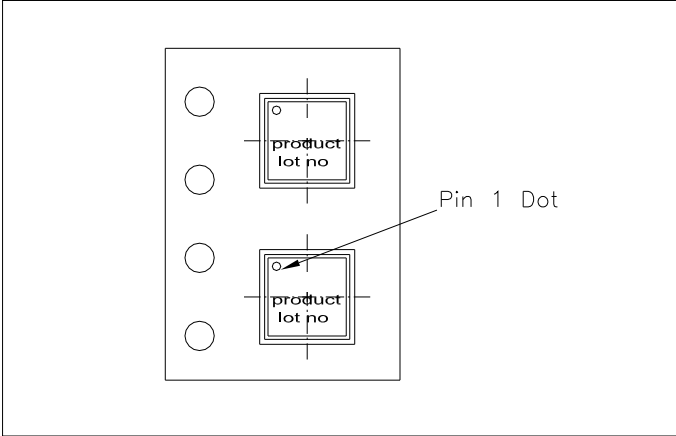
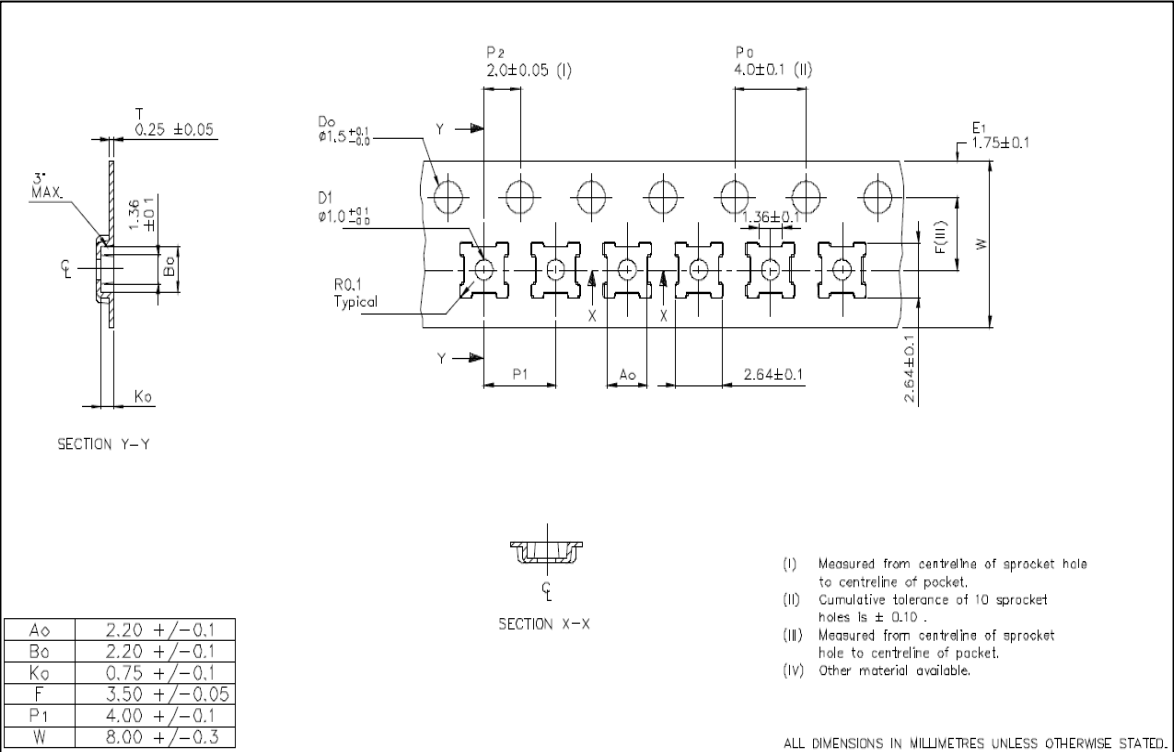

Figure 7: SE2601T Tape and Reel Specification

DATA SHEET
SE2601T: 2.4 GHz WLAN Switch/LNA Front End

Document Change History

Revision	Date	Notes
1.0	09/08/2009	Created
1.1	09/10/2009	Corrected package height on page 1
1.2	12/18/2009	Updated ESD specification, Package Outline and added recommended PCB footprint
1.3	Jan-06-2010	Updated ESD specification and corrected typo
1.4	March-01-2010	Added Tape and reel specification
1.5	June-10-2010	Updated tape and reel information
1.6	August-02-2010	Updated ESD specification
1.7	January-23-2011	Updated BT IP1dB and VIH specification
1.8	April-10-2012	Updated with Skyworks logo and disclaimer statement

Copyright © 2012 Skyworks Solutions, Inc. All Rights Reserved.

Information in this document is provided in connection with Skyworks Solutions, Inc. ("Skyworks") products or services. These materials, including the information contained herein, are provided by Skyworks as a service to its customers and may be used for informational purposes only by the customer. Skyworks assumes no responsibility for errors or omissions in these materials or the information contained herein. Skyworks may change its documentation, products, services, specifications or product descriptions at any time, without notice. Skyworks makes no commitment to update the materials or information and shall have no responsibility whatsoever for conflicts, incompatibilities, or other difficulties arising from any future changes.

No license, whether express, implied, by estoppel or otherwise, is granted to any intellectual property rights by this document. Skyworks assumes no liability for any materials, products or information provided hereunder, including the sale, distribution, reproduction or use of Skyworks products, information or materials, except as may be provided in Skyworks Terms and Conditions of Sale.

THE MATERIALS, PRODUCTS AND INFORMATION ARE PROVIDED "AS IS" WITHOUT WARRANTY OF ANY KIND, WHETHER EXPRESS, IMPLIED, STATUTORY, OR OTHERWISE, INCLUDING FITNESS FOR A PARTICULAR PURPOSE OR USE, MERCHANTABILITY, PERFORMANCE, QUALITY OR NON-INFRINGEMENT OF ANY INTELLECTUAL PROPERTY RIGHT; ALL SUCH WARRANTIES ARE HEREBY EXPRESSLY DISCLAIMED. SKYWORKS DOES NOT WARRANT THE ACCURACY OR COMPLETENESS OF THE INFORMATION, TEXT, GRAPHICS OR OTHER ITEMS CONTAINED WITHIN THESE MATERIALS. SKYWORKS SHALL NOT BE LIABLE FOR ANY DAMAGES, INCLUDING BUT NOT LIMITED TO ANY SPECIAL, INDIRECT, INCIDENTAL, STATUTORY, OR CONSEQUENTIAL DAMAGES, INCLUDING WITHOUT LIMITATION, LOST REVENUES OR LOST PROFITS THAT MAY RESULT FROM THE USE OF THE MATERIALS OR INFORMATION, WHETHER OR NOT THE RECIPIENT OF MATERIALS HAS BEEN ADVISED OF THE POSSIBILITY OF SUCH DAMAGE.

Skyworks products are not intended for use in medical, lifesaving or life-sustaining applications, or other equipment in which the failure of the Skyworks products could lead to personal injury, death, physical or environmental damage. Skyworks customers using or selling Skyworks products for use in such applications do so at their own risk and agree to fully indemnify Skyworks for any damages resulting from such improper use or sale.

Customers are responsible for their products and applications using Skyworks products, which may deviate from published specifications as a result of design defects, errors, or operation of products outside of published parameters or design specifications. Customers should include design and operating safeguards to minimize these and other risks. Skyworks assumes no liability for applications assistance, customer product design, or damage to any equipment resulting from the use of Skyworks products outside of stated published specifications or parameters.

Skyworks, the Skyworks symbol, and "Breakthrough Simplicity" are trademarks or registered trademarks of Skyworks Solutions, Inc., in the United States and other countries. Third-party brands and names are for identification purposes only, and are the property of their respective owners. Additional information, including relevant terms and conditions, posted at www.skyworksinc.com, are incorporated by reference.