

DATA SHEET
SE5007BT: 5 GHz Front End Module with Power Detector

Applications

- 5 GHz WLAN (IEEE802.11a/g/n)
- Access Points, PCMCIA, PC cards, Handhelds

Features

- 5GHz Front End Module with PA, LNA and T/R Switch
- Integrated power amplifier enable pin (V_{EN})
- Buffered, temperature compensated power detector
- High and Low-Linearity mode
- 3% EVM, @17dBm, 64 QAM, 54 Mbps
- 30 dB Typical Gain
- Lead Free and RoHS compliant, halogen free package
- 16 pin 3 mm x 3 mm x 0.6 mm QFN, MSL1

Product Description

The SE5007BT is a 5GHz front end module offering high linear power for wireless LAN applications. It incorporates a power detector for control of the output power.

The SE5007BT offers a high level of integration for a simplified design, providing quicker time to market and higher application board production yield. The device integrates inter-stage match, a temperature compensated, load insensitive power detector with 20dB of dynamic range, a 3.8GHz notch filter, a T/R switch and an Rx LNA.

For wireless LAN applications, the device meets the requirements of IEEE802.11a and delivers approximately 17dBm of linear output power. It also features a low linearity mode control to reduce current consumption at low power modes.

The SE5007BT integrates the reference voltage generator, allowing for a true 1.8V CMOS compatible digital EN (enable) function to turn the power amplifier on and off.

Ordering Information

Part Number	Package	Remark
SE5007BT	16 Pin QFN	Samples
SE5007BT-R	16 Pin QFN	Tape and Reel
SE5007BT-EK1	Evaluation Kit	Standard

Functional Block Diagram

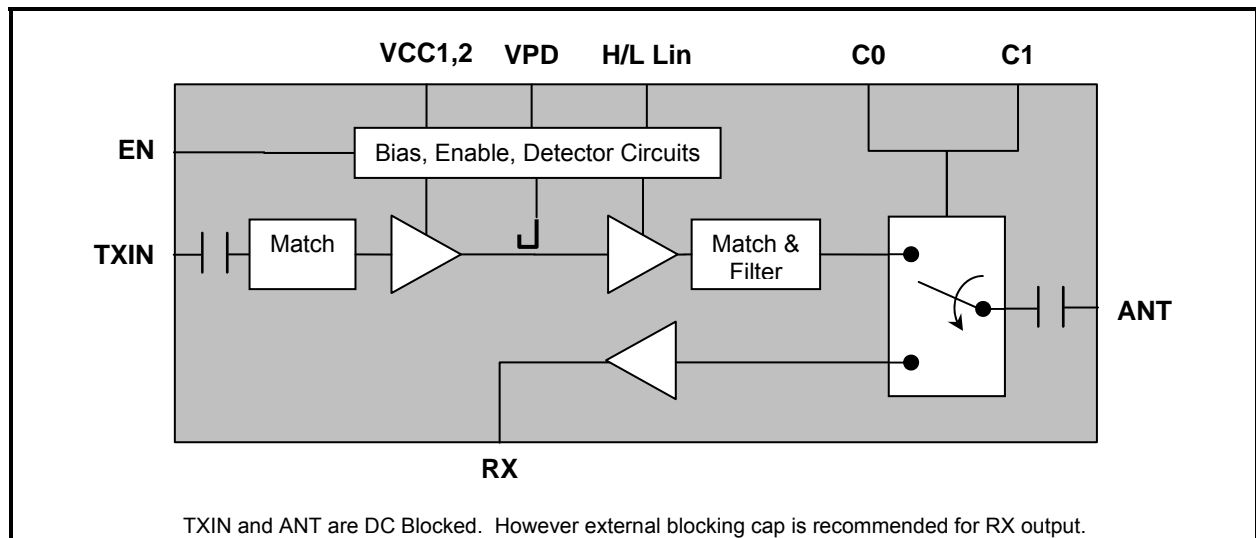

Figure 1: Functional Block Diagram

DATA SHEET
SE5007BT: 5 GHz Front End Module with Power Detector

Pin Out Diagram

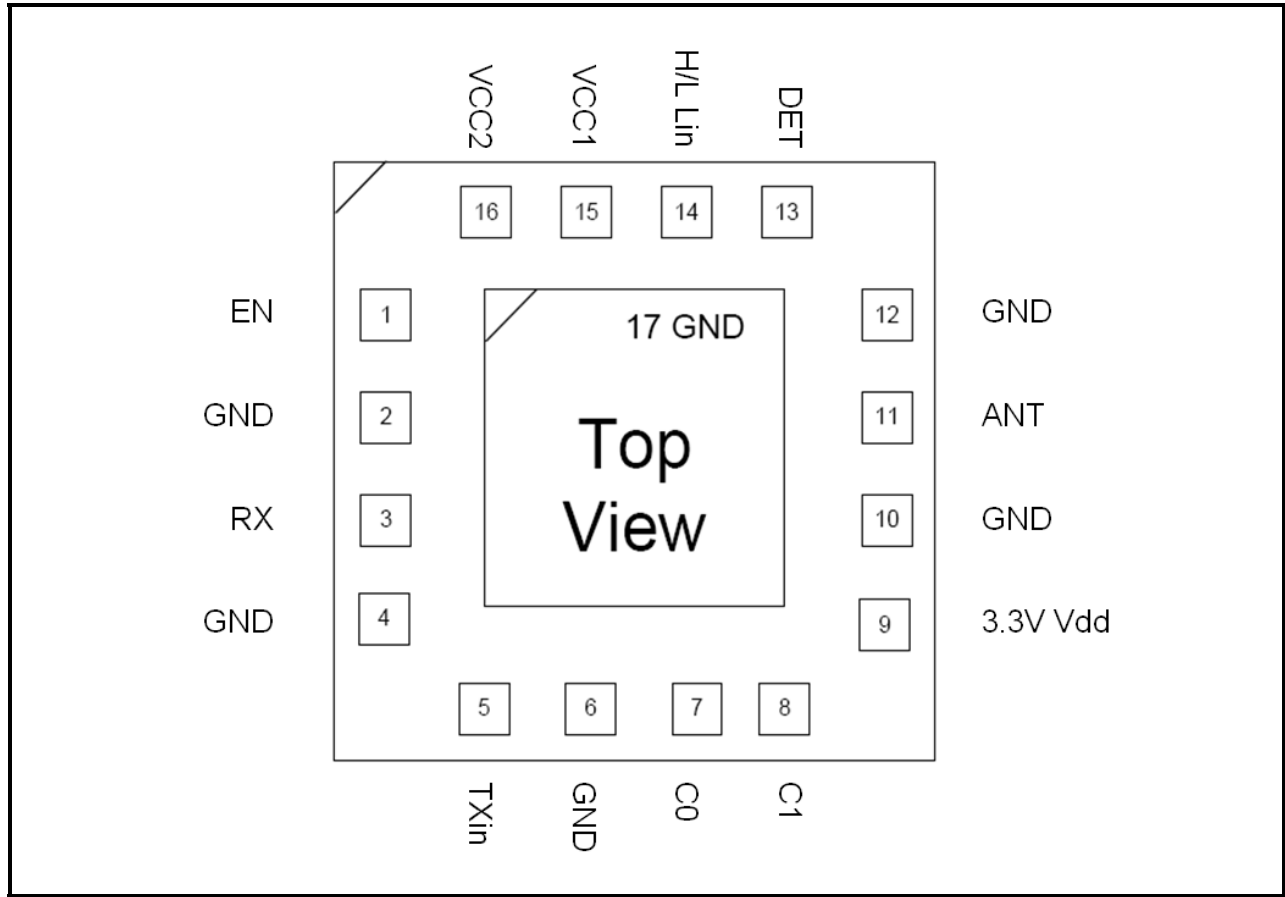

Figure 2: SE5007BT Pin-Out Diagram

Pin Out Description

Pin No.	Name	Description
1	EN	PA Enable
2	GND	Ground
3	RX	5GHz LNA Output Signal
4	GND	Ground
5	TXIN	5GHz TX RF Input Signal
6	GND	Ground
7	C0	Switch Control Logic 1
8	C1	Switch Control Logic 2

Pin No.	Name	Description
9	VDD	LNA Supply Voltage (3.3V+/-10% only)
10	GND	Ground
11	ANT	5GHz Antenna output
12	GND	Ground
13	DET	Power Detector Output
14	H/L Lin	High-Low linearity Control
15	VCC1	Power Stage Supply Voltage
16	VCC2	Bias, Driver Stage Supply Voltage

DATA SHEET
SE5007BT: 5 GHz Front End Module with Power Detector

Absolute Maximum Ratings

These are stress ratings only. Exposure to stresses beyond these maximum ratings for a long period of time may cause permanent damage to, or affect the reliability of the device. Avoid operating the device outside the recommended operating conditions defined below. This device is ESD sensitive. Handling and assembly of this device should be at ESD protected workstations.

Symbol	Definition	Min.	Max.	Unit	
V _{CC1}	Supply Voltage on pin 15 (VCC1)	-0.3	4.8	V	
V _{DD} , V _{CC2}	Supply Voltage on pins 9, 16 (VDD, VCC2)	-0.3	3.6	V	
EN	DC input on Enable	-0.3	3.6	V	
TXIN	RF Input Power, RFout into 50Ω match	-	12	dBm	
T _{STG}	Storage Temperature Range	-40	150	°C	
ESD _{HBM}	JEDEC JESD22-A114 all pins	Antenna Pin	-	1000	V
		All Other Pins	-	350	

Recommended Operating Conditions

Symbol	Parameter	Min.	Max.	Unit
V _{CC1}	Supply Voltage on pin 15 (VCC1)	3.0	4.5	V
V _{DD} , V _{CC2}	Supply Voltage on pins 9, 16 (VDD, VCC2)	3.0	3.6	V
T _A	Ambient Temperature	-40	85	°C

Control Logic Characteristics

Conditions: V_{CC1} = V_{CC2} = V_{DD} = V_{PAON} = V_{EN} = 3.3 V, T_A = 25 °C, as measured on Skyworks Solutions' SE5007T-EV1 evaluation board, unless otherwise noted.

Symbol	Parameter	Conditions	Min.	Typ.	Max.	Unit
I _{CC-802.11a}	Supply Current, Transmit Mode	P _{OUT} = 17 dBm, 54 Mbps, 64 QAM, H/L Lin = 3.3V (High Linearity Mode)	-	195	-	mA
		P _{OUT} = 13 dBm, 54 Mbps, 64 QAM, H/L Lin = 0V (Low Linearity Mode)	-	140	-	
		P _{OUT} = 5 dBm, 54 Mbps, 64 QAM, H/L Lin = 0V (Low Linearity Mode)	-	105	-	
		P _{OUT} = 19 dBm, 54 Mbps, 64 QAM, H/L Lin = 3.3V, VCC1 = 4.0V	-	220	-	
	Supply Current, Receive Mode	V _{EN} = C0 = 0V; C1 = 3.3V	-	15	-	
		V _{EN} = C0 = C1 = 0V	-	0.02	-	
I _{OFF}	Supply Current	V _{EN} = 0 V, No RF, C0=C1=0 V Measured on VCC, VDD pins	-	20	50	μA
V _{ENH}	Logic High Voltage	-	1.6	-	V _{CC}	V

DATA SHEET
SE5007BT: 5 GHz Front End Module with Power Detector

Symbol	Parameter	Conditions	Min.	Typ.	Max.	Unit
V _{ENL}	Logic Low Voltage	-	-0.3	-	0.3	V
I _{ENH}	Input Current Logic High Voltage	-	-	330	400	μA
I _{ENL}	Input Current Logic Low Voltage	-	-	<1	-	μA

Switch Logic Characteristics

Conditions: V_{CC} = V_{DD} V_{EN} = 3.3 V, T_A = 25 °C, as measured on Skyworks Solutions' SE5007BT-EK1 evaluation board, all unused ports terminated with 50 ohms, unless otherwise noted.

Symbol	Parameter	Conditions	Min.	Typ.	Max.	Unit
ON	Low Loss Switch Control Voltage	High State = V _{CTL_ON} - V _{CTL_OFF}	2.8	-	3.6	V
OFF	High Loss Switch Control Voltage	Low State = V _{CTL_OFF} - V _{CTL_OFF}	0	-	0.3	V
C _{CTL}	Control Input Capacitance	-	-	-	100	pF
I _{CTL}	Control Line Current	V _{CTL} = V _{CTL_ON}	-	2	10	μA

Switch Control Logic Table

C0	C1	EN	Hi/L Lin	ANT
ON	OFF	ON	OFF	TX Low Linearity
ON	OFF	ON	ON	TX High Linearity
OFF	OFF	OFF	D/C	Rx Bypass
OFF	ON	OFF	D/C	Rx LNA ON
ON	ON	Un-supported state		

DATA SHEET
SE5007BT: 5 GHz Front End Module with Power Detector

AC Electrical Characteristics

Transmit Characteristics

Conditions: $V_{CC1} = V_{CC2} = V_{DD} = V_{EN} = C0 = H/L Lin = 3.3V$, $C1 = 0V$, $T_A = 25\text{ }^\circ\text{C}$, as measured on Skyworks Solutions' SE5007T-EV1 evaluation board, unless otherwise noted

Symbol	Parameter	Conditions	Min.	Typ.	Max.	Unit	
f_{L-U}	Frequency Range	-	4.90	-	5.85	GHz	
P _{OUT}	Output Power, High Linearity Mode H/L Lin = 3.3V OFDM	802.11a, 64 QAM	EVM = 3%	-	17	-	dBm
			EVM = 2%	-	15	-	
		VCC1 = 4.0V, 3% EVM	EVM = 3%	-	19	-	
			MCS0, HT20, mask compliant	-	21	-	
			MCS0, HT40, mask compliant	-	20	-	
	Output Power, Low Linearity Mode H/L Lin = 0V OFDM	802.11a, 64 QAM, EVM = 3%	-	13	-		
		MCS0, HT20, mask compliant	-	17	-		
		MCS0, HT40, mask compliant	-	16	-		
P _{1dB}	Output 1dB compression point	No modulation	-	24	-	dBm	
S ₁₁	Input Return Loss	P _{IN} = -25 dBm	-	14	-	dB	
S ₂₁	Small Signal Gain, P _{IN} = -25dBm	High Linearity Mode	28	31	-	dB	
		Low Linearity Mode	26	30	-		
ΔS_{21}	Small Signal Gain Variation	Gain variation over single 40MHz channel	-	-	0.5	dB	
		Gain Variation over band	-1.5	-	1.5		
S _{21_3.8}	Out of Band Gain	Gain at 3.8GHz	-	-	15	dB	
2f	Harmonic	P _{OUT} = 17 dBm, OFDM	-	-50	-42	dBm/MHz	
3f			-	-50	-42		
t _r , t _f	Rise and Fall Time	-	-	0.5	-	us	
STAB	Stability	P _{OUT} = 17 dBm, 54 Mbps, 64 QAM, VSWR = 6:1, all phases	All non-harmonically related outputs less than -50 dBc/100 kHz				
Ruggedness	Tolerance to output load mismatching	Constant P _{IN} equal to P _{OUT} = 17 dBm at 50ohms, 54 Mbps, 64 QAM, VSWR = 6:1, all phases	No damage				
Robust	Robustness to input power	P _{IN} = 12dBm, CW, VSWR = 6:1, all phases	No damage				

DATA SHEET
SE5007BT: 5 GHz Front End Module with Power Detector

Receive Characteristics

Conditions: $V_{CC} = C1 = V_{DD} = 3.3V$, $V_{EN} = C0 = 0V$, $T_A = 25\text{ }^\circ\text{C}$, as measured on Skyworks Solutions' SE5007BT-EK1 evaluation board, all unused ports terminated with 50 ohms, unless otherwise noted.

Symbol	Parameter	Condition	Min.	Typ.	Max.	Unit
F _{OUT}	Frequency Range	-	4.9	-	5.85	GHz
RX	Insertion Loss	Bypass Mode: C0 = C1 = 0V	-	-5	-	dB
	RX Gain	High Gain Mode	11	12	-	
NF	Noise Figure	High Gain Mode	-	2.5	-	dB
RX _{RL}	Input Return Loss	At the Antenna port	-	12	-	dB
	Output Return Loss	At RX RF output	-	8	-	
RxIP1DB	Input P1DB	Measured at ANT Port; High Gain Mode	-	-5	-	dBm
		LNA Bypass Mode	-	10	-	
Rx_2.4int	Max 2.4Ghz interferer Amplitude	1 dB degradation of IP1DB	-	-10	-7	dBm
T _{on/off}	T/R on/off switching speed	C0, C1 (50%) to RF output (10% or 90%)	-	300	-	nSec

DATA SHEET
SE5007BT: 5 GHz Front End Module with Power Detector

Power Detector Characteristics

Conditions: $V_{CC} = V_{EN} = C0 = V_{DD} = 3.3V$, $C1 = 0V$, $f = 5.4\text{ GHz}$, $T_A = 25\text{ }^\circ\text{C}$, as measured on Skyworks Solutions' SE5007BT-EV1 evaluation board, unless otherwise noted

Symbol	Parameter	Conditions	Min.	Typ.	Max.	Unit
PDR	P _{OUT} detect range	-	0	-	P _{1dB}	dBm
VDET ₂₂	Detector voltage	P _{OUT} = 22 dBm	0.7	-	0.9	V
VDET ₁₆	Detector voltage	P _{OUT} = 16 dBm	0.50	-	0.60	V
VDET ₂	Detector voltage	P _{OUT} = 2 dBm	0.25	-	0.35	V
PDZ _{OUT}	Output Impedance	-	-	5	-	KΩ

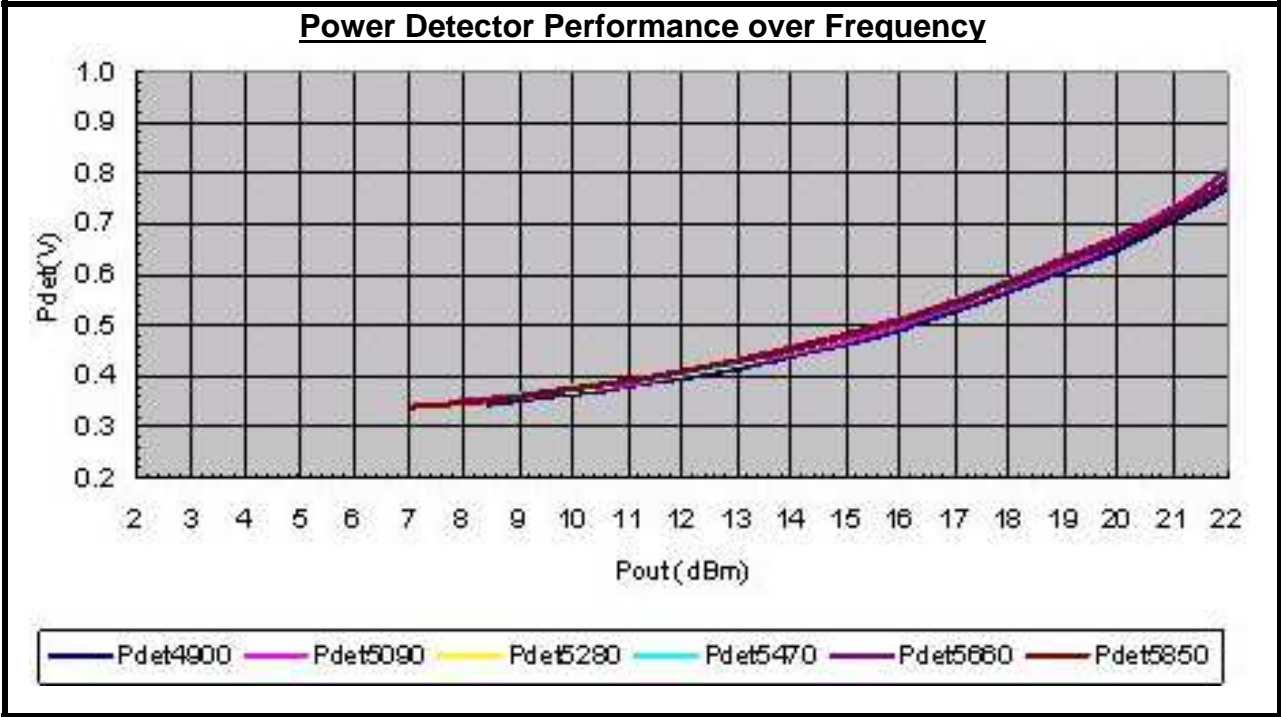

Figure 3: SE5007BT Power Detector Characteristic

DATA SHEET
SE5007BT: 5 GHz Front End Module with Power Detector

Package Diagram

This package is Pb free and RoHS compliant. The product is rated MSL1.

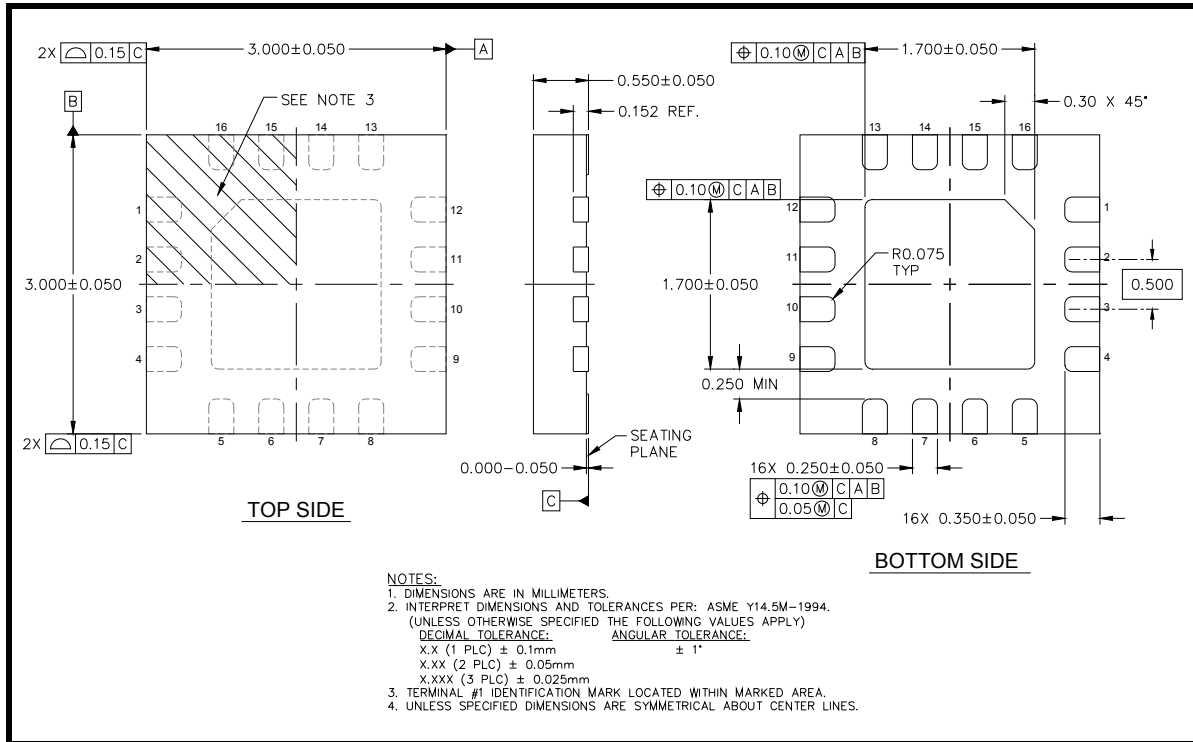

Figure 4: SE5007BT Package Diagram



DATA SHEET

SE5007BT: 5 GHz Front End Module with Power Detector

Recommended Land and Solder Patterns

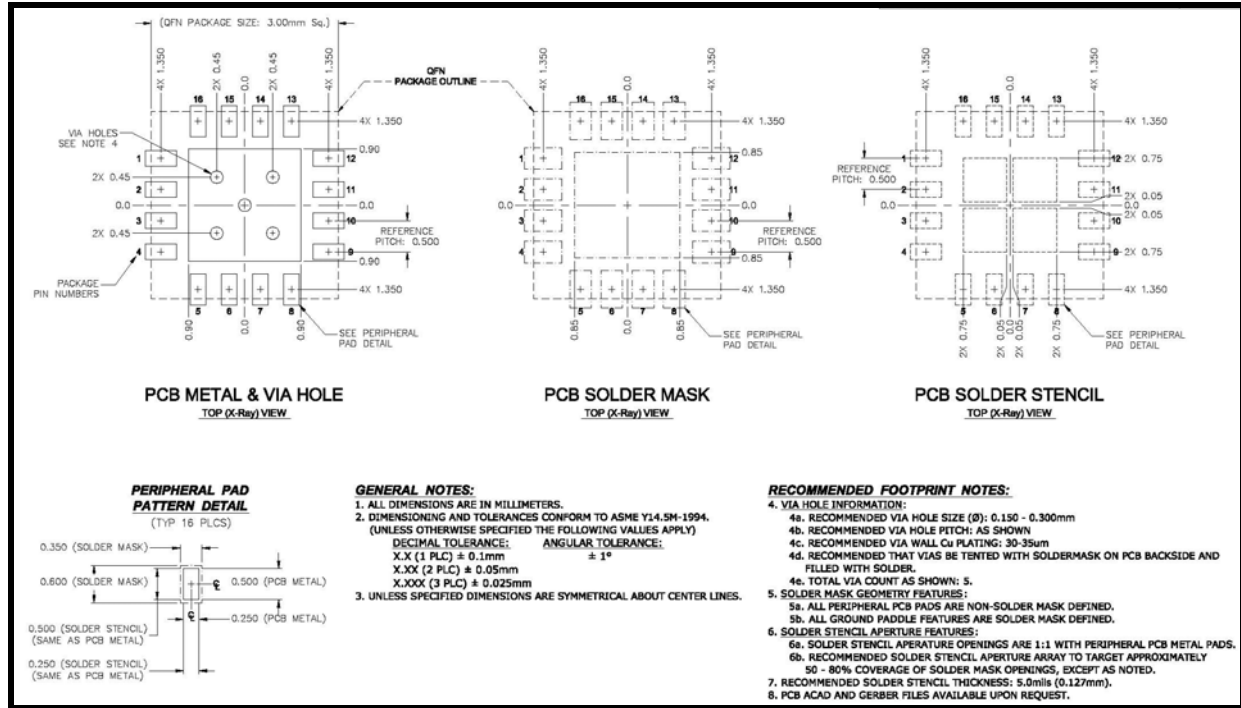

Figure 5: SE5007BT Recommended Land and Solder Pattern

Package Handling Information

Because of its sensitivity to moisture absorption, instructions on the shipping container label must be followed regarding exposure to moisture after the container seal is broken, otherwise, problems related to moisture absorption may occur when the part is subjected to high temperature during solder assembly. The SE5007BT is capable of withstanding a Pb free solder reflow. Care must be taken when attaching this product, whether it is done manually or in a production solder reflow environment. If the part is manually attached, precaution should be taken to insure that the device is not subjected to temperatures above its rated peak temperature for an extended period of time. For details on both attachment techniques, precautions, and handling procedures recommended, please refer to:

- "Quad Flat No-Lead Module Solder Reflow & Rework Information", Document Number QAD-00045
- "Handling, Packing, Shipping and Use of Moisture Sensitive QFN", Document Number QAD-00044



Caution! Class 1A ESD sensitive device

DATA SHEET
SE5007BT: 5 GHz Front End Module with Power Detector

Branding Information

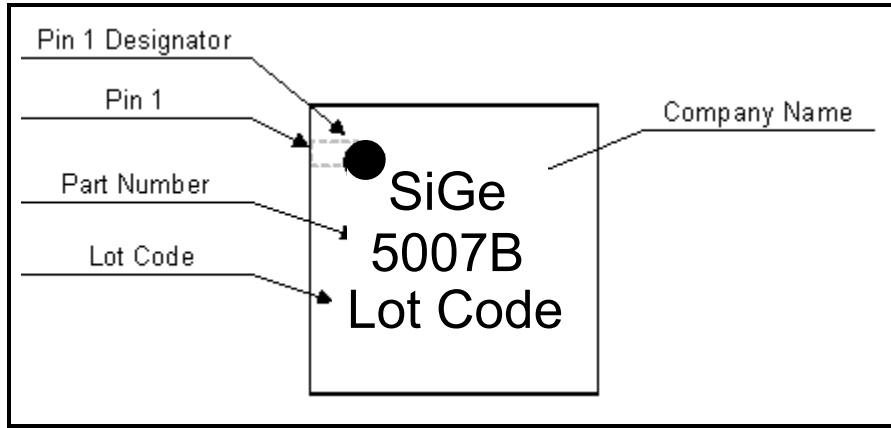

Figure 6: SE5007BT Branding

Tape and Reel Information

Parameter	Value
Devices Per Reel	3000
Reel Diameter	13 inches
Tape Width	12 millimeters

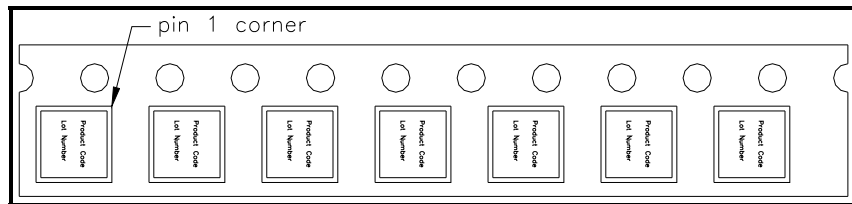

Figure 7: SE5007BT-R Tape and Reel Information

Document Change History

Revision	Date	Notes
1.0	Nov 03, 2010	Created
1.1	Nov 22, 2010	Updated Supply voltage specs
1.2	Dec 20, 2010	Corrected RX Conditions in Control Logic table
1.3	Jan 03, 2011	Updated recommended storage temperature
1.4	Feb 8, 2011	Added 4V operation, Mask Performance, Added reference to blocked RF ports on the block diagram
1.5	Apr 25, 2011	Update V _{ENH} (min) from 2.8V to 1.6V Corrected product description – removed reference to Balun
1.6	Apr 11, 2012	Updated with Skyworks logo and disclaimer statement



SKYWORKS®

DATA SHEET

SE5007BT: 5 GHz Front End Module with Power Detector

Copyright © 2012 Skyworks Solutions, Inc. All Rights Reserved.

Information in this document is provided in connection with Skyworks Solutions, Inc. ("Skyworks") products or services. These materials, including the information contained herein, are provided by Skyworks as a service to its customers and may be used for informational purposes only by the customer. Skyworks assumes no responsibility for errors or omissions in these materials or the information contained herein. Skyworks may change its documentation, products, services, specifications or product descriptions at any time, without notice. Skyworks makes no commitment to update the materials or information and shall have no responsibility whatsoever for conflicts, incompatibilities, or other difficulties arising from any future changes.

No license, whether express, implied, by estoppel or otherwise, is granted to any intellectual property rights by this document. Skyworks assumes no liability for any materials, products or information provided hereunder, including the sale, distribution, reproduction or use of Skyworks products, information or materials, except as may be provided in Skyworks Terms and Conditions of Sale.

THE MATERIALS, PRODUCTS AND INFORMATION ARE PROVIDED "AS IS" WITHOUT WARRANTY OF ANY KIND, WHETHER EXPRESS, IMPLIED, STATUTORY, OR OTHERWISE, INCLUDING FITNESS FOR A PARTICULAR PURPOSE OR USE, MERCHANTABILITY, PERFORMANCE, QUALITY OR NON-INFRINGEMENT OF ANY INTELLECTUAL PROPERTY RIGHT; ALL SUCH WARRANTIES ARE HEREBY EXPRESSLY DISCLAIMED. SKYWORKS DOES NOT WARRANT THE ACCURACY OR COMPLETENESS OF THE INFORMATION, TEXT, GRAPHICS OR OTHER ITEMS CONTAINED WITHIN THESE MATERIALS. SKYWORKS SHALL NOT BE LIABLE FOR ANY DAMAGES, INCLUDING BUT NOT LIMITED TO ANY SPECIAL, INDIRECT, INCIDENTAL, STATUTORY, OR CONSEQUENTIAL DAMAGES, INCLUDING WITHOUT LIMITATION, LOST REVENUES OR LOST PROFITS THAT MAY RESULT FROM THE USE OF THE MATERIALS OR INFORMATION, WHETHER OR NOT THE RECIPIENT OF MATERIALS HAS BEEN ADVISED OF THE POSSIBILITY OF SUCH DAMAGE.

Skyworks products are not intended for use in medical, lifesaving or life-sustaining applications, or other equipment in which the failure of the Skyworks products could lead to personal injury, death, physical or environmental damage. Skyworks customers using or selling Skyworks products for use in such applications do so at their own risk and agree to fully indemnify Skyworks for any damages resulting from such improper use or sale.

Customers are responsible for their products and applications using Skyworks products, which may deviate from published specifications as a result of design defects, errors, or operation of products outside of published parameters or design specifications. Customers should include design and operating safeguards to minimize these and other risks. Skyworks assumes no liability for applications assistance, customer product design, or damage to any equipment resulting from the use of Skyworks products outside of stated published specifications or parameters.

Skyworks, the Skyworks symbol, and "Breakthrough Simplicity" are trademarks or registered trademarks of Skyworks Solutions, Inc., in the United States and other countries. Third-party brands and names are for identification purposes only, and are the property of their respective owners. Additional information, including relevant terms and conditions, posted at www.skyworksinc.com, are incorporated by reference.