

SURFACE MOUNT SILICON RECTIFIER

VOLTAGE RANGE 50 to 1000 Volts CURRENT 0.5 Ampere

FEATURES

- * Ideal for surface mounted applications
- * Low leakage current
- * Metallurgically bonded construction
- * Mounting position: Any
- * Weight: 0.016 gram

MECHANICAL DATA

- * Epoxy : Device has UL flammability classification 94V-0

MAXIMUM RATINGS AND ELECTRICAL CHARACTERISTICS

Ratings at 25 °C ambient temperature unless otherwise specified.
 Single phase, half wave, 60 Hz, resistive or inductive load.
 For capacitive load, derate current by 20%.



SOD-123F

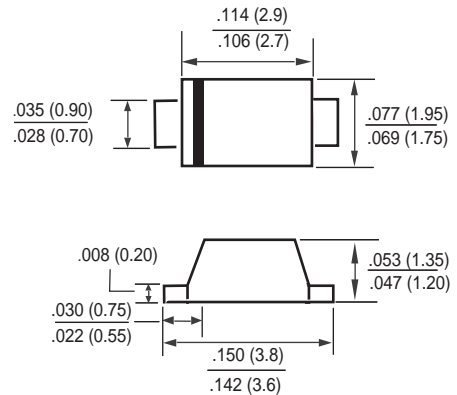

Dimensions in inches and (millimeters)

MAXIMUM RATINGS (At TA = 25°C unless otherwise noted)

RATINGS	SYMBOL	05A1	05A2	05A3	05A4	05A5	05A6	05A7	UNITS
Maximum Recurrent Peak Reverse Voltage	VRRM	50	100	200	400	600	800	1000	Volts
Maximum RMS Voltage	VRMS	35	70	140	280	420	560	700	Volts
Maximum DC Blocking Voltage	Vdc	50	100	200	400	600	800	1000	Volts
Maximum Average Forward Rectified Current at TA = 55°C	Io	0.5							Amps
Peak Forward Surge Current IFM(surge): 8.3 ms single half sine-wave superimposed on rated load (JEDEC method)	IFSM	15							Amps
Typical Junction Capacitance (Note 1)	Cj	14							pF
Operating and Storage Temperature Range	TJ, TSTG	-55 to +150							°C

ELECTRICAL CHARACTERISTICS (At TA = 25°C unless otherwise noted)

CHARACTERISTICS	SYMBOL	05A1	05A2	05A3	05A4	05A5	05A6	05A7	UNITS
Maximum Forward Voltage at 0.5A DC	VF	1.1							Volts
Maximum Full Load Reverse Current, Full cycle Average at TA=55°C	IR	30							uAmps
Maximum DC Average Reverse Current at @TA = 25°C		5.0							uAmps
Rated DC Blocking Voltage @TA = 100°C		50							uAmps

NOTES : 1. Measured at 1.0 MHz and applied average voltage of 4.0VDC
 2. "Fully ROHS compliant", "100% Sn plating (Pb-free)".

RATING AND CHARACTERISTIC CURVES (05A1 THRU 05A7)

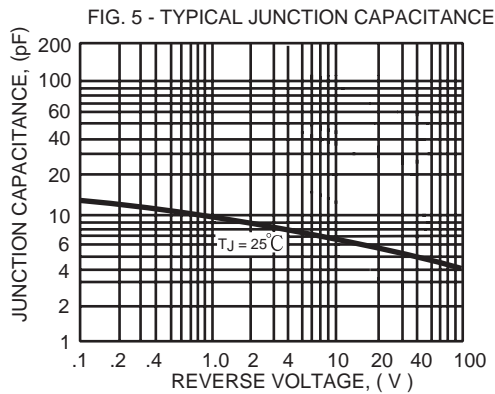
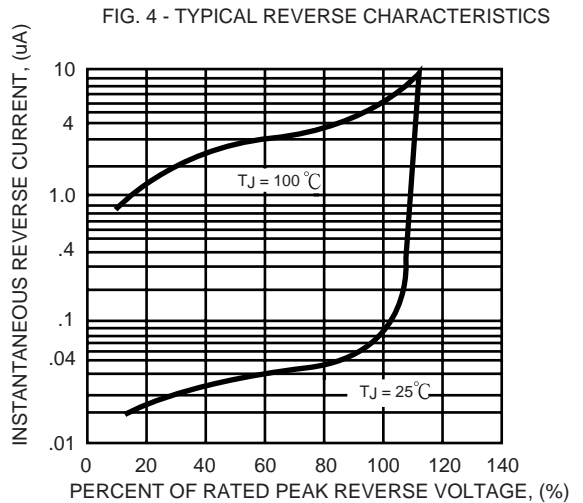
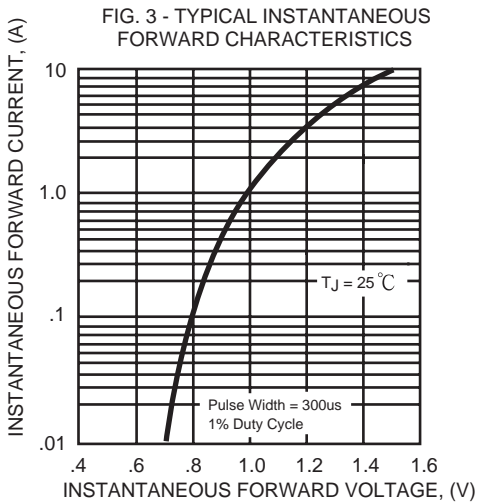
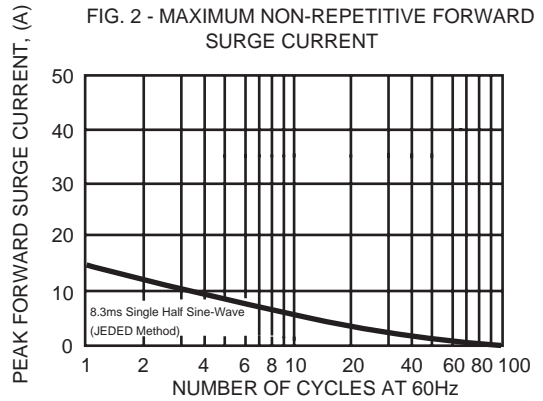
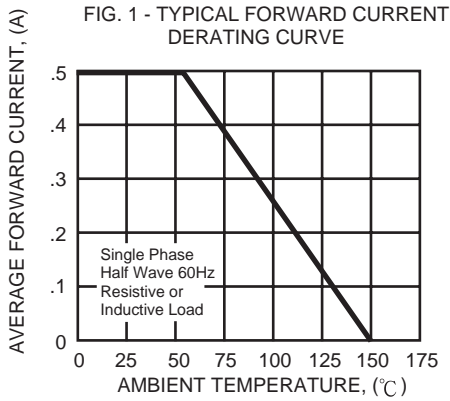

Mounting Pad Layout

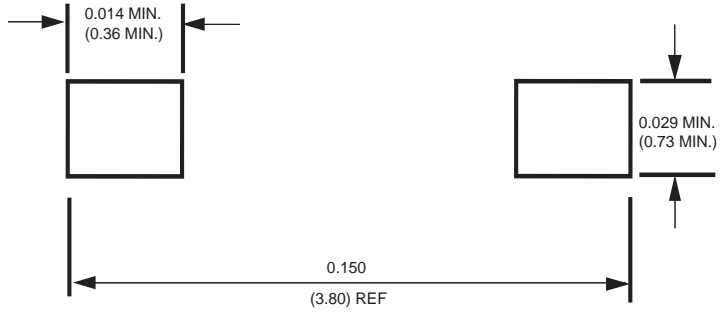

Dimensions in inches and (millimeters)