

SURFACE MOUNT FAST RECOVERY RECTIFIER

VOLTAGE RANGE 50 to 600 Volts CURRENT 0.5 Ampere

FEATURES

- * Fast switching
- * Low leakage
- * Low forward voltage drop
- * High current capability
- * High current surge
- * High reliability

MECHANICAL DATA

- * Epoxy: Device has UL flammability classification 94V-O
- * Mounting position: Any
- * Weight: 0.016 gram

MAXIMUM RATINGS AND ELECTRICAL CHARACTERISTICS

Ratings at 25 °C ambient temperature unless otherwise specified.
Single phase, half wave, 60 Hz, resistive or inductive load.
For capacitive load, derate current by 20%.

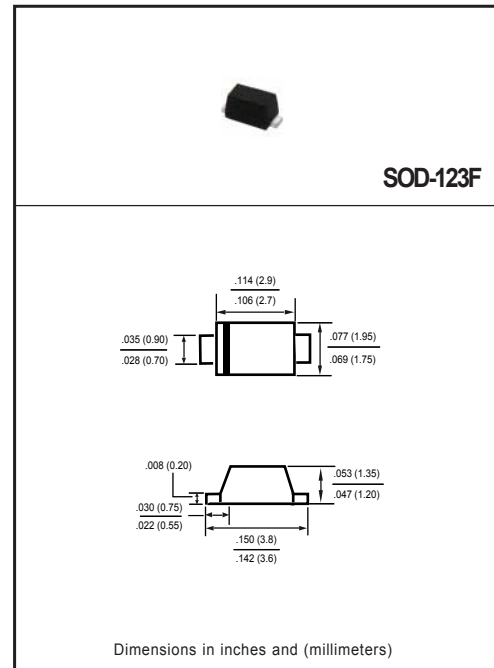

MAXIMUM RATINGS (@ TA=25 °C unless otherwise noted)

RATINGS	SYMBOL	05F1	05F2	05F3	05F4	05F5	UNITS
Maximum Recurrent Peak Reverse Voltage	V _{RRM}	50	100	200	400	600	Volts
Maximum RMS Voltage	V _{RMS}	35	70	140	280	420	Volts
Maximum DC Blocking Voltage	V _{DC}	50	100	200	400	600	Volts
Maximum Average Forward Rectified Current at T _A = 55°C	I _O	0.5					Amps
Peak Forward Surge Current 8.3 ms single half sine-wave superimposed on rated load (JEDEC method)	I _{FSM}	15					Amps
Typical Thermal Resistance (Note 4)	R _{θJA}	32					°C/W
	R _{θJL}	150					
Typical Junction Capacitance (Note 2)	C _J	15					pF
Operating and Storage Temperature Range	T _J , T _{STG}	-55 to + 150					°C

ELECTRICAL CHARACTERISTICS (@TA=25 °C unless otherwise noted)

CHARACTERISTICS	SYMBOL	05F1	05F2	05F3	05F4	05F5	UNITS
Maximum Instantaneous Forward Voltage at 1.0ADC	V _F	1.3					Volts
Maximum DC Reverse Current at Rated DC Blocking Voltage T _A = 25°C	I _R	5.0					uAmps
Maximum Full Load Reverse Current Full Cycle Average, .375" (9.5mm) lead length at T _L = 55°C		100					
Maximum Reverse Recovery Time (Note 1)	t _{rr}	150				250	nSec

- NOTES : 1. Reverse Recovery Test Conditions: I_F = 0.5A, I_R = -1.0A, I_{RR} = -0.25A
2. Measured at 1 MHz and applied reverse voltage of 4.0 volts
3. "Fully ROHS compliant", "100% Sn plating (Pb-free)".
4. Thermal Resistance : Mounted on PCB.

RATING AND CHARACTERISTICS CURVES (05F1 THRU 05F5)

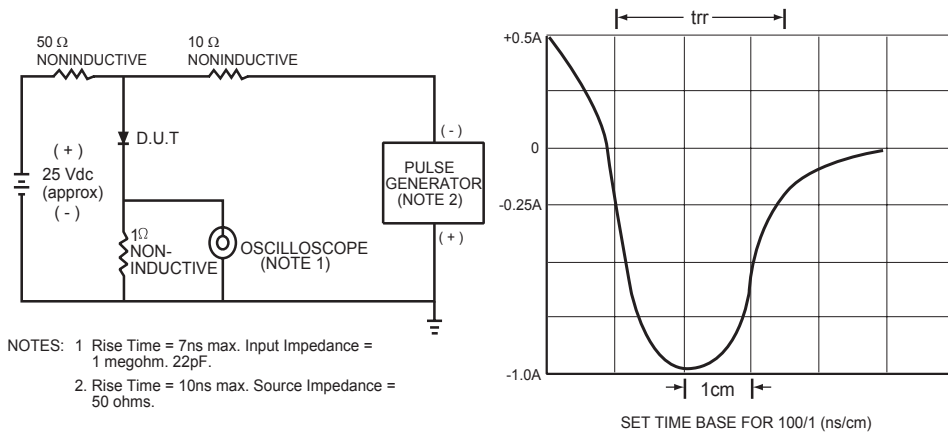

FIG.1 TEST CIRCUIT DIAGRAM AND REVERSE RECOVERY TIME CHARACTERISTIC

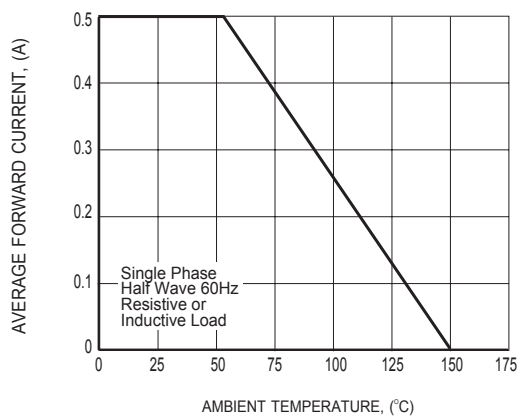

FIG.2 TYPICAL FORWARD CURRENT DERATING CURVE

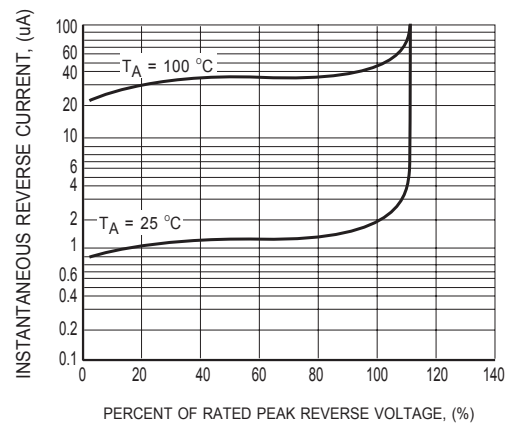

FIG.3 TYPICAL REVERSE CHARACTERISTICS

RATING AND CHARACTERISTICS CURVES (05F1 THRU 05F5)

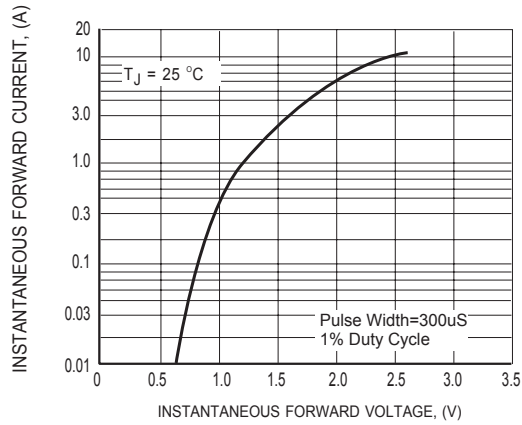

FIG.4 TYPICAL INSTANTANEOUS FORWARD CHARACTERISTICS

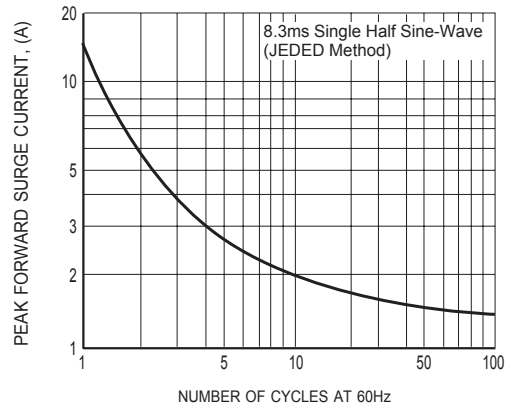

FIG.5 MAXIMUM NON-REPETITIVE FORWARD SURGE CURRENT

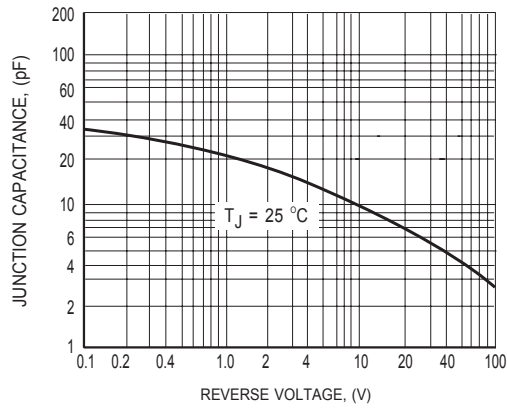
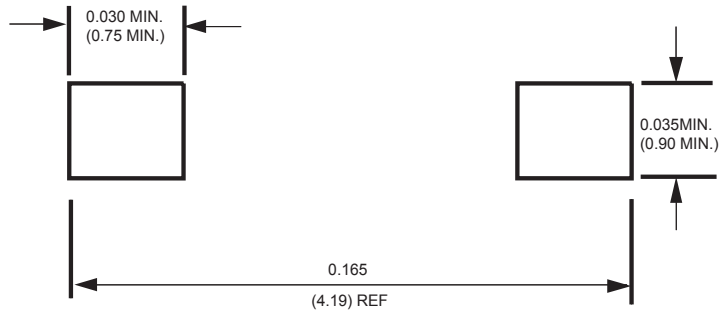

FIG.6 TYPICAL JUNCTION CAPACITANCE

Mounting Pad Layout



Dimensions in inches and (millimeters)

DISCLAIMER NOTICE

Rectron Inc reserves the right to make changes without notice to any product specification herein, to make corrections, modifications, enhancements or other changes. Rectron Inc or anyone on its behalf assumes no responsibility or liability for any errors or inaccuracies. Data sheet specifications and its information contained are intended to provide a product description only. "Typical" parameters which may be included on RECTRON data sheets and/ or specifications can and do vary in different applications and actual performance may vary over time. Rectron Inc does not assume any liability arising out of the application or use of any product or circuit.

Rectron products are not designed, intended or authorized for use in medical, life-saving implant or other applications intended for life-sustaining or other related applications where a failure or malfunction of component or circuitry may directly or indirectly cause injury or threaten a life without expressed written approval of Rectron Inc. Customers using or selling Rectron components for use in such applications do so at their own risk and shall agree to fully indemnify Rectron Inc and its subsidiaries harmless against all claims, damages and expenditures.