

**SURFACE MOUNT HIGH EFFICIENCY RECTIFIER**

**VOLTAGE RANGE 50 to 600 Volts CURRENT 0.5 Ampere**

**FEATURES**

- \* Low power loss, high efficiency
- \* Low leakage
- \* Low forward voltage
- \* High current capability
- \* High speed switching
- \* High surge capability
- \* High reliability

**MECHANICAL DATA**

- \* Epoxy: Device has UL flammability classification 94V-O
- \* Mounting position: Any
- \* Weight: 0.016 gram

**MAXIMUM RATINGS AND ELECTRICAL CHARACTERISTICS**

Ratings at 25 °C ambient temperature unless otherwise specified.  
 Single phase, half wave, 60 Hz, resistive or inductive load.  
 For capacitive load, derate current by 20%.

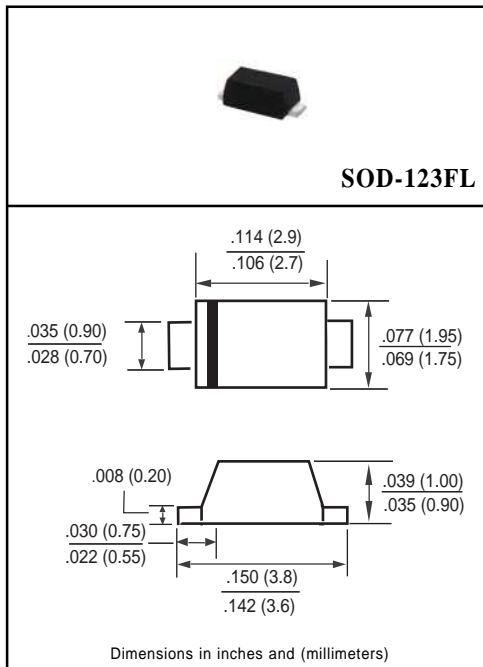

**MAXIMUM RATINGS** (At TA = 25°C unless otherwise noted)

RATINGS	SYMBOL	05H1L	05H2L	05H3L	05H4L	05H5L	05H6L	UNITS
Maximum Recurrent Peak Reverse Voltage	VRRM	50	100	200	300	400	600	Volts
Maximum RMS Voltage	VRMS	35	70	140	210	280	420	Volts
Maximum DC Blocking Voltage	VDC	50	100	200	300	400	600	Volts
Maximum Average Forward Rectified Current at TA= 55°C	Io	0.5						Amps
Peak Forward Surge Current 8.3 ms single half sine-wave superimposed on rated load (JEDEC method)	IFSM	15						Amps
Typical Junction Capacitance (Note 2)	Cj	15					12	pF
Operating and Storage Temperature Range	TJ, TSTG	-55 to + 150						°C

**ELECTRICAL CHARACTERISTICS** (At TA = 25°C unless otherwise noted)

CHARACTERISTICS	SYMBOL	05H1L	05H2L	05H3L	05H4L	05H5L	05H6L	UNITS
Maximum Instantaneous Forward Voltage at 0.5A DC	VF	1.0			1.3		1.7	Volts
Maximum DC Reverse Current at Rated DC Blocking Voltage TA = 25°C	IR	5.0						uAmps
Maximum Full Load Reverse Current Average, Full Cycle .375" (9.5mm) lead length at TL = 55°C		100						uAmps
Maximum Reverse Recovery Time (Note 1)	trr	50					75	nSec

NOTES : 1. Test Conditions: IF = 0.5A, IR = -1.0A, IRR = -0.25A

2. Measured at 1 MHz and applied reverse voltage of 4.0 volts

3. "Fully ROHS compliant", "100% Sn plating (Pb-free)".

# RATING AND CHARACTERISTIC CURVES ( 05H1L THRU 05H6L )

FIG. 1 - TEST CIRCUIT DIAGRAM AND REVERSE RECOVERY TIME CHARACTERISTIC

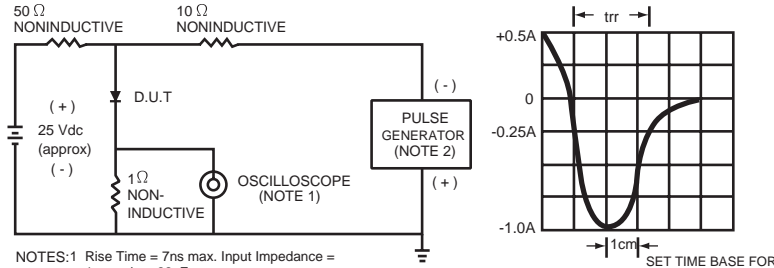

FIG. 2 - TYPICAL FORWARD CURRENT DERATING CURVE

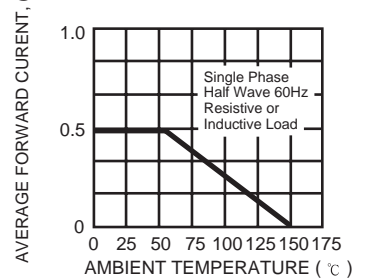

FIG. 3 - TYPICAL REVERSE CHARACTERISTICS

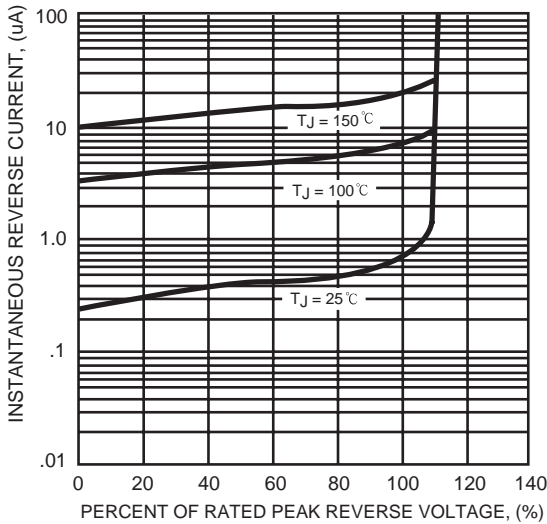

FIG. 4 - TYPICAL INSTANTANEOUS FORWARD CHARACTERISTICS

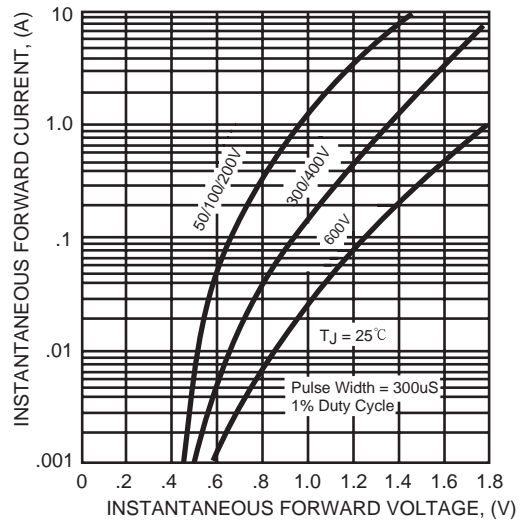

FIG. 5 - MAXIMUM NON-REPETITIVE FORWARD SURGE CURRENT

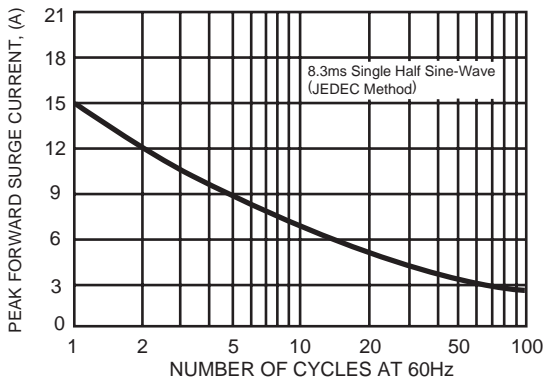
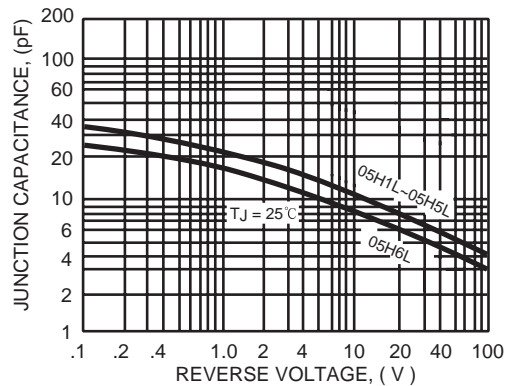
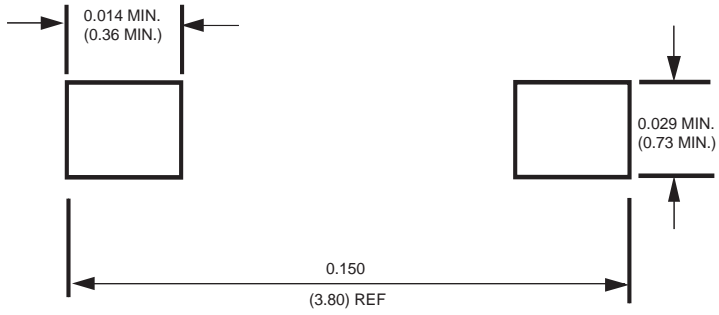

FIG. 6 - TYPICAL JUNCTION CAPACITANCE



## Mounting Pad Layout



Dimensions in inches and (millimeters)