

DATA SHEET

SKY65336-11: 2.4 GHz Transmit/Receive Front-End Module with Integrated LNA

Applications

- 2.4 GHz ISM band radios
- ZigBee® FEMs
- IEEE 802.15.4 applications

Features

- Transmit output power > +20 dBm
- Receive NF < 3 dB
- High efficiency PA
- Programmable transmit power levels
- Configurable transmit/receive paths
- Internal switching and control circuits
- Internal RF match and bias circuits
- Single DC supply = 3.0 V
- Interfaces seamlessly with Ember EM250 and EM260 ZigBee transceivers
- All RF ports are internally DC blocked
- Small footprint, MCM (28-pin, 8 x 8 mm) SMT package (MSL3, 260 °C per JEDEC J-STD-020)

Description

Skyworks SKY65336-11 is a high-efficiency Front-End Module (FEM) for ZigBee and other 2.4 GHz ISM band applications. The small 8 x 8 mm Multi-Chip Module (MCM) contains a 2400-2500 MHz high-efficiency transmit path and a low-noise linear receive path.

The transmit path consists of an harmonic filter and high efficiency Power Amplifier (PA) capable of providing +20 dBm of power at the antenna port. Also included is an internal balun to allow use of differential input signals.

The receive path contains a high isolation Transmit/Receive (Tx/Rx) switch, Low Noise Amplifier (LNA), and balun for low noise differential output.

The device is mounted in a 28-pin, 8 x 8 mm MCM Surface-Mounted Technology (SMT) package, which allows for a highly manufacturable low-cost solution.

A block diagram of the SKY65336-11 is shown in Figure 1. The device package and pinout for the 28-pin MCM are shown in Figure 2.

 Skyworks Pb-free products are compliant with all applicable legislation. For additional information, refer to *Skyworks Definition of Lead (Pb)-Free*, document number SQ04-0073.

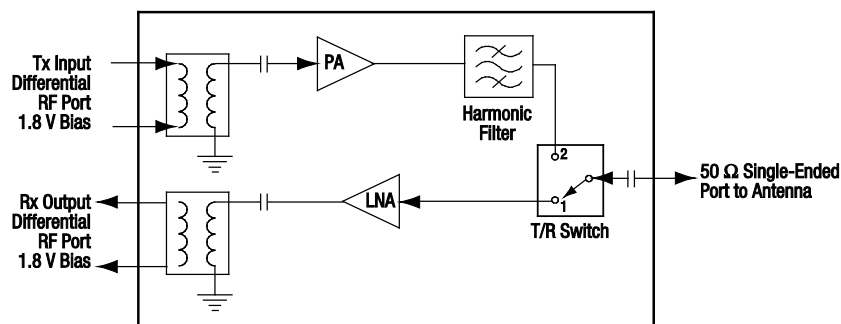

Figure 1. SKY65336-11 Block Diagram

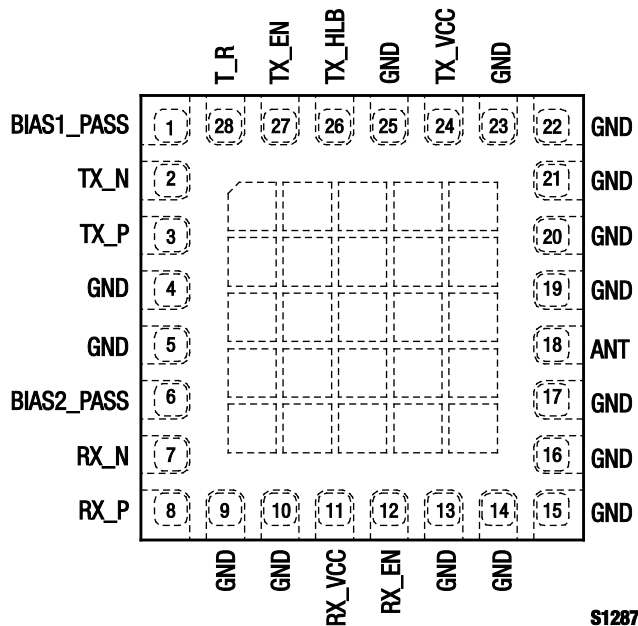

Figure 2. SKY65336-11 Pinout – 28-Pin MCM (Top View)

Technical Description

Transmit/Receive (Tx/Rx) Enable

Pin 27 (TX_EN) and pin 12 (RX_EN) are used to enable the transmit and receive port, respectively.

Tx/Rx Switch

Pin 28 (T_R) is used to control the Tx/Rx switch.

Tx/Rx Enable and Tx/Rx Switch Mode Control

The following control logic is used to configure the transmit or receive mode of the SKY65336-11:

TX_EN	RX_EN	T_R	Mode
High	Low	High	Transmit mode
Low	High	Low	Receive mode

High Power and Low Power Modes

High power mode output is 20 dBm and low power mode output is 10 dBm. Pin 26 (TX_HLB) sets the transmit path in high power or low power mode according to the following logic:

TX_HLB	State
Low	High power mode
High	Low power mode

Bottom Center Paddles

The bottom center paddles must be electrically grounded for proper RF performance. Customers should place adequate thermal vias under the ground paddles for optimum thermal performance. The Evaluation Board layout (see Figures 3 and 4) can be used as a guide for RF ground and thermal layout.

Electrical and Mechanical Specifications

Signal pin assignments and functional pin descriptions are described in Table 1. The absolute maximum ratings of the SKY65336-11 are provided in Table 2. Recommended operating conditions are noted in Table 3 and electrical specifications are provided in Table 4.

Typical performance characteristics of the SKY65336-11 are shown in Figures 3 through 12.

Table 1. SKY65336-11 Signal Descriptions

Pin #	Name	Description	Pin #	Name	Description
1	BIAS1_PASS	Transmit port bias supply	15	GND	Ground
2	TX_N	Negative transmit input port	16	GND	Ground
3	TX_P	Positive transmit input port	17	GND	Ground
4	GND	Ground	18	ANT	Antenna input
5	GND	Ground	19	GND	Ground
6	BIAS2_PASS	Receive port bias supply	20	GND	Ground
7	RX_N	Negative receive output port	21	GND	Ground
8	RX_P	Positive receive output port	22	GND	Ground
9	GND	Ground	23	GND	Ground
10	GND	Ground	24	TX_VCC	Transmit DC supply, +3 V
11	RX_VCC	Receive DC supply, +3 V	25	GND	Ground
12	RX_EN	Receive enable	26	TX_HLB	Transmit power mode
13	GND	Ground	27	TX_EN	Transmit enable
14	GND	Ground	28	T_R	Transmit/receive switch

Note: The bottom ground pad **must be** connected to RF ground.

Table 2. SKY65336-11 Absolute Maximum Ratings (Note 1)

Parameter	Symbol	Minimum	Maximum	Units
Supply voltage	RX_VCC, TX_VCC	2.1	4	V
Control Voltage	BIAS1_PASS, BIAS2_PASS, TX_EN, RX_EN, TX_HLB, T_R		3.6	V
Bypass voltage	BIAS1_PASS, BIAS2_PASS		1.9	V
RF input power, antenna port	P _{IN_ANT}		10	dBm
RF input power, transmit port	P _{IN_TX}		+8	dBm
Case operating temperature	T _C	-40	+85	°C
Storage temperature	T _{ST}	-55	+125	°C
Junction temperature	T _J		+150	°C

Note 1: Exposure to maximum rating conditions for extended periods may reduce device reliability. There is no damage to device with only one parameter set at the limit and all other parameters set at or below their nominal value. Exceeding any of the limits listed here may result in permanent damage to the device.

CAUTION: Although this device is designed to be as robust as possible, Electrostatic Discharge (ESD) can damage this device. This device must be protected at all times from ESD. Static charges may easily produce potentials of several kilovolts on the human body or equipment, which can discharge without detection. Industry-standard ESD precautions should be used at all times.

Table 3. SKY65336-11 Recommended Operating Conditions

Parameter	Symbol	Minimum	Typical	Maximum	Units
Supply voltage (TX_VCC, RX_VCC)	VCC	2.7	3.0	3.6	V
Tx/Rx bias supply voltage	BIAS1_PASS, BIAS2_PASS	1.7	1.8	1.9	V
Tx/Rx enable voltage:					
Low	TX_ENL, RX_ENL		0	0.1	V
High	TX_ENH, RX_ENH	1.62	1.80	VCC – 0.2	V
Tx/Rx control voltage:					
Low	T_RL, TX_HLBL		0	0.1	V
High	T_RH, TX_HLBH	1.62	1.80	VCC – 0.2	V
Frequency range	f	2400		2500	MHz

Table 4. SKY65336-11 Electrical Specifications (Note 1)
(VCC = 3.0 V, Tc = 25 °C, Unless Otherwise Noted)

Parameter	Symbol	Test Condition	Min	Typical	Max	Units
Frequency range	f		2400		2500	MHz
Return loss	RL	All RF ports	6	10		dB
Transmitter Section						
Input power range	PIN	CW, high or low power mode		+3	+5	dBm
Transmit saturated output power	PSAT_H	High power mode	+19.5	+20		dBm
	PSAT_L	Low power mode	+8	+10		dBm
Operating current	IOP_H	POUT = +20 dBm in high power mode		145	160	mA
	IOP_L	POUT = +10 dBm in low power mode		70	80	mA
Harmonic levels (Note 2)	PN	CW, POUT = +20 dBm in high power mode, POUT = +10 dBm in low power mode		-44	-39	dBm
Saturated gain	GH	CW, high power mode		17		dB
	GL	CW, low power mode		7		dB
Leakage current	I _{LEAK}	No RF input, VCC = 3.0 V, RX_EN = 0 V, TX_EN = 0 V		0.5	2.0	μA
Receiver Section (Frequency = 2445 MHz)						
Small signal gain	G	CW	9.5	10.5		dB
Noise Figure	NF			2.0	3.0	dB
Input 1 dB compression	IP1dB	CW		-11		dBm
Input IP3	IIP3	Two CW tones spaced 1 MHz apart @ PIN = -9 dBm	-1	+3		dBm
Operating current	I _{CC}	CW		8	15	mA
Leakage current	I _{LEAK}	No RF input, VCC = 3.0 V, RX_EN = 0 V, TX_EN = 0 V		0.5	2.0	μA

Note 1: Performance is guaranteed only under the conditions listed in this Table.

Note 2: Harmonic levels using the Zigbee modulated signal are +6 dBm lower than the values shown here.

Typical Performance Characteristics
 (VCC = 3.0 V, Tc = 25 °C, Unless Otherwise Noted)

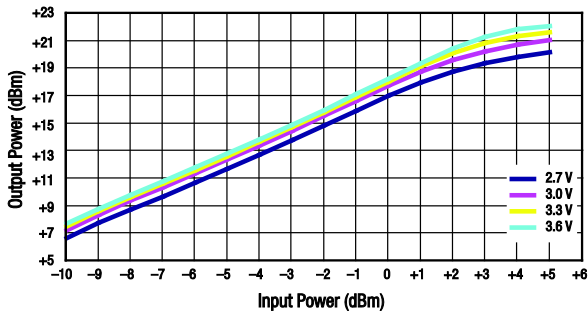

Figure 3. Output Power vs Input Power Over Voltage @ 2450 MHz

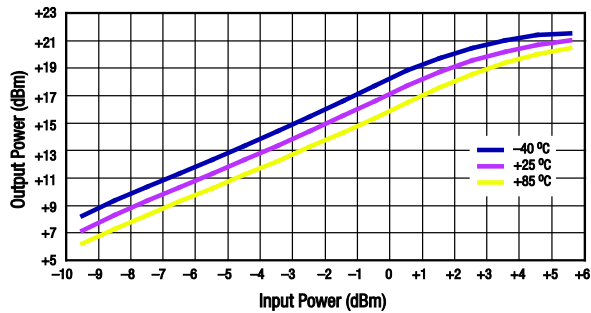

Figure 4. Output Power vs Input Power Over Temperature @ 2450 MHz

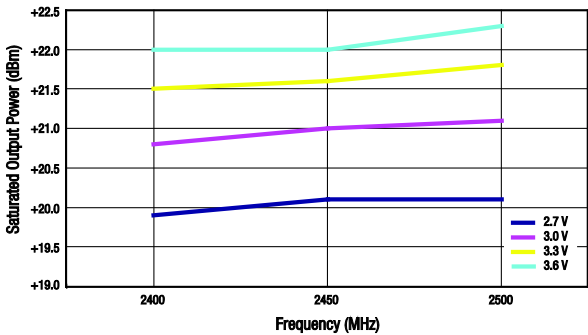

Figure 5. Saturated Output Power vs Frequency Over Voltage

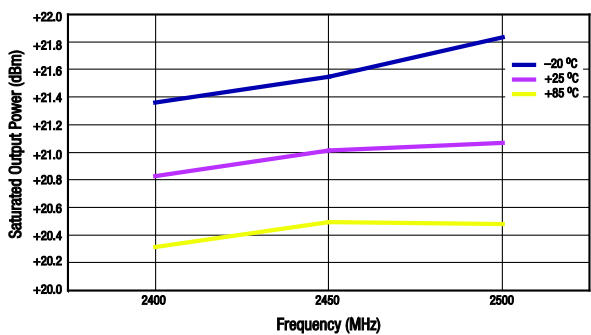

Figure 6. Saturated Output Power vs Frequency Over Temperature

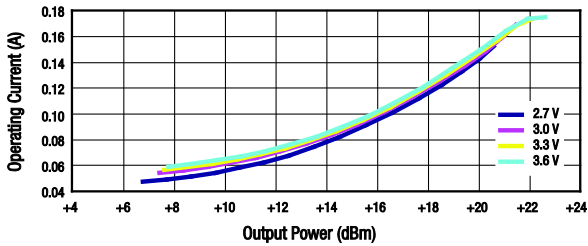

Figure 7. Operating Current vs Output Power Over Voltage @ 2450 MHz

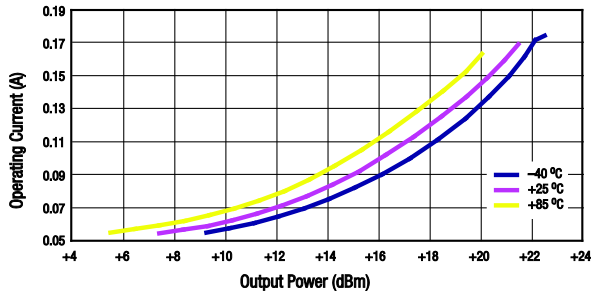

Figure 8. Operating Current vs Output Power Over Temperature @ 2450 MHz

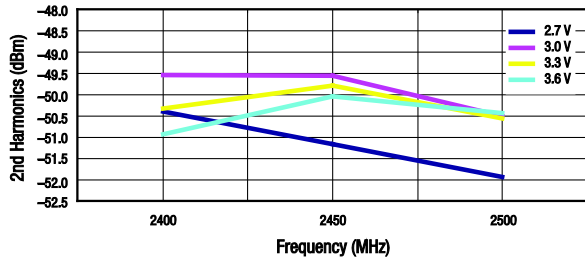

Figure 9. Second Harmonics vs Frequency Over Voltage (High Power Mode)

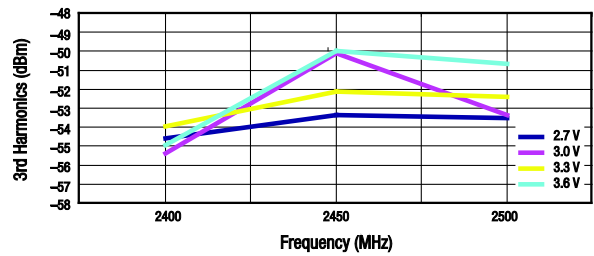

Figure 10. Third Harmonics vs Frequency Over Voltage (High Power Mode)

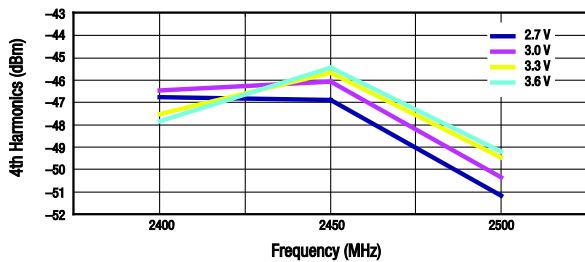

Figure 11. Fourth Harmonics vs Frequency Over Voltage (High Power Mode)

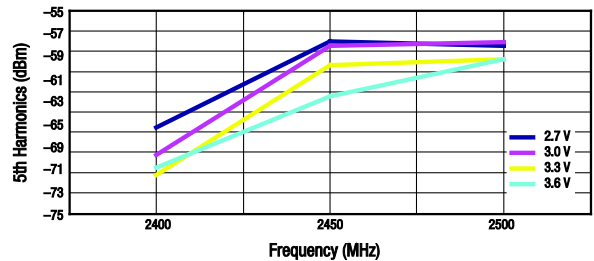

Figure 12. Fifth Harmonics vs Frequency Over Voltage (High Power Mode)

Evaluation Board Description

The SKY65336-11 Evaluation Board is used to test the performance of the SKY65336-11 FEM. The Evaluation Board schematic diagram is shown in Figure 13. An assembly drawing for the Evaluation Board is shown in Figure 14.

Package Dimensions

The PCB layout footprint for the SKY65336-11 is shown in Figure 15. Package dimensions for the 28-pin MCM are shown in Figure 16, and tape and reel dimensions are provided in Figure 17.

Package and Handling Information

Since the device package is sensitive to moisture absorption, it is baked and vacuum packed before shipping. Instructions on the

shipping container label regarding exposure to moisture after the container seal is broken must be followed. Otherwise, problems related to moisture absorption may occur when the part is subjected to high temperature during solder assembly.

The SKY65336-11 is rated to Moisture Sensitivity Level 3 (MSL3) at 260 °C. It can be used for lead or lead-free soldering. For additional information, refer to Skyworks Application Note, *PCB Design and SMT Assembly/Rework Guidelines for MCM-L Packages*, document number 101752.

Care must be taken when attaching this product, whether it is done manually or in a production solder reflow environment. Production quantities of this product are shipped in a standard tape and reel format.

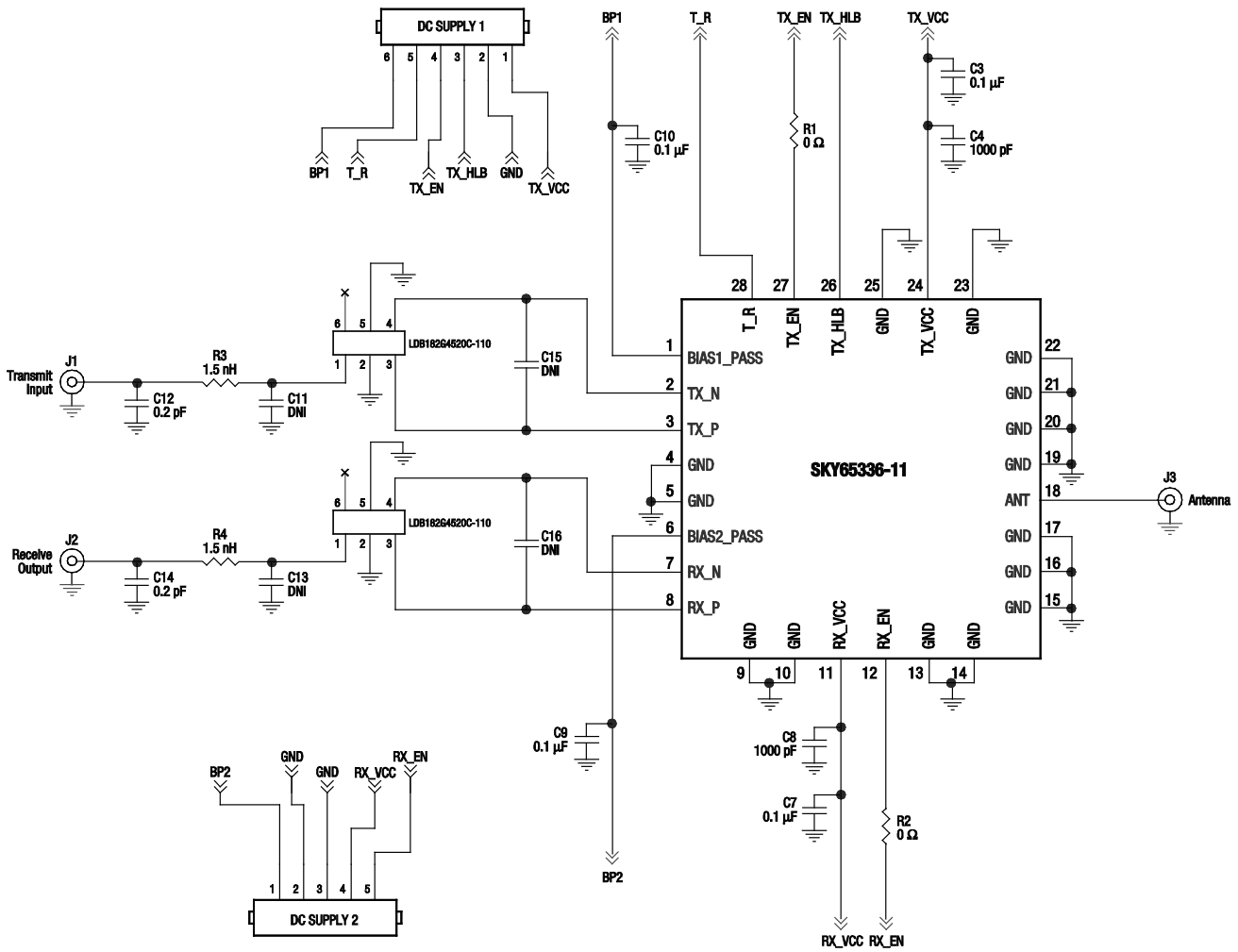

Note: Some component labels may be different than the corresponding component symbol shown here. Component values, however, are accurate as of the date of this Data Sheet.

S1292

Figure 13. SKY65336-11 Evaluation Board Schematic

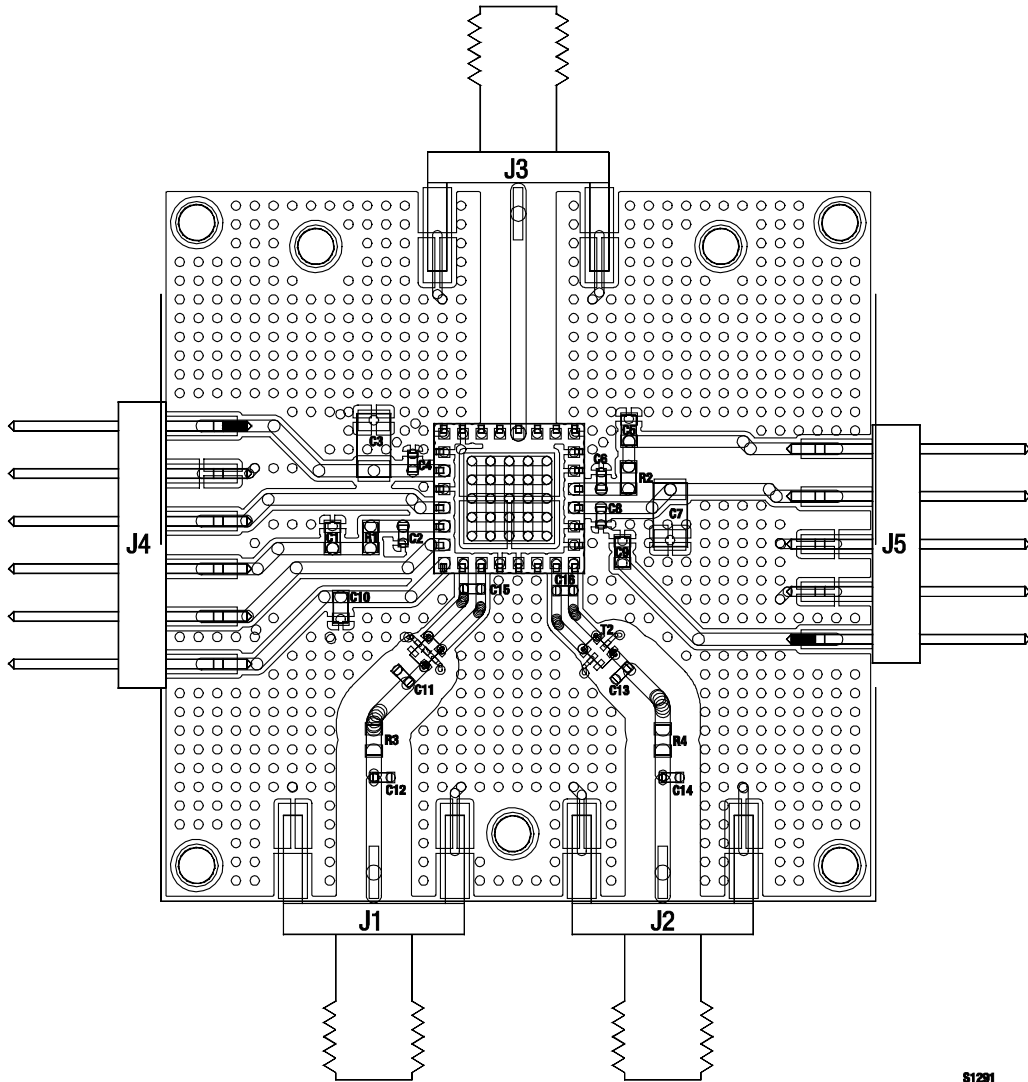
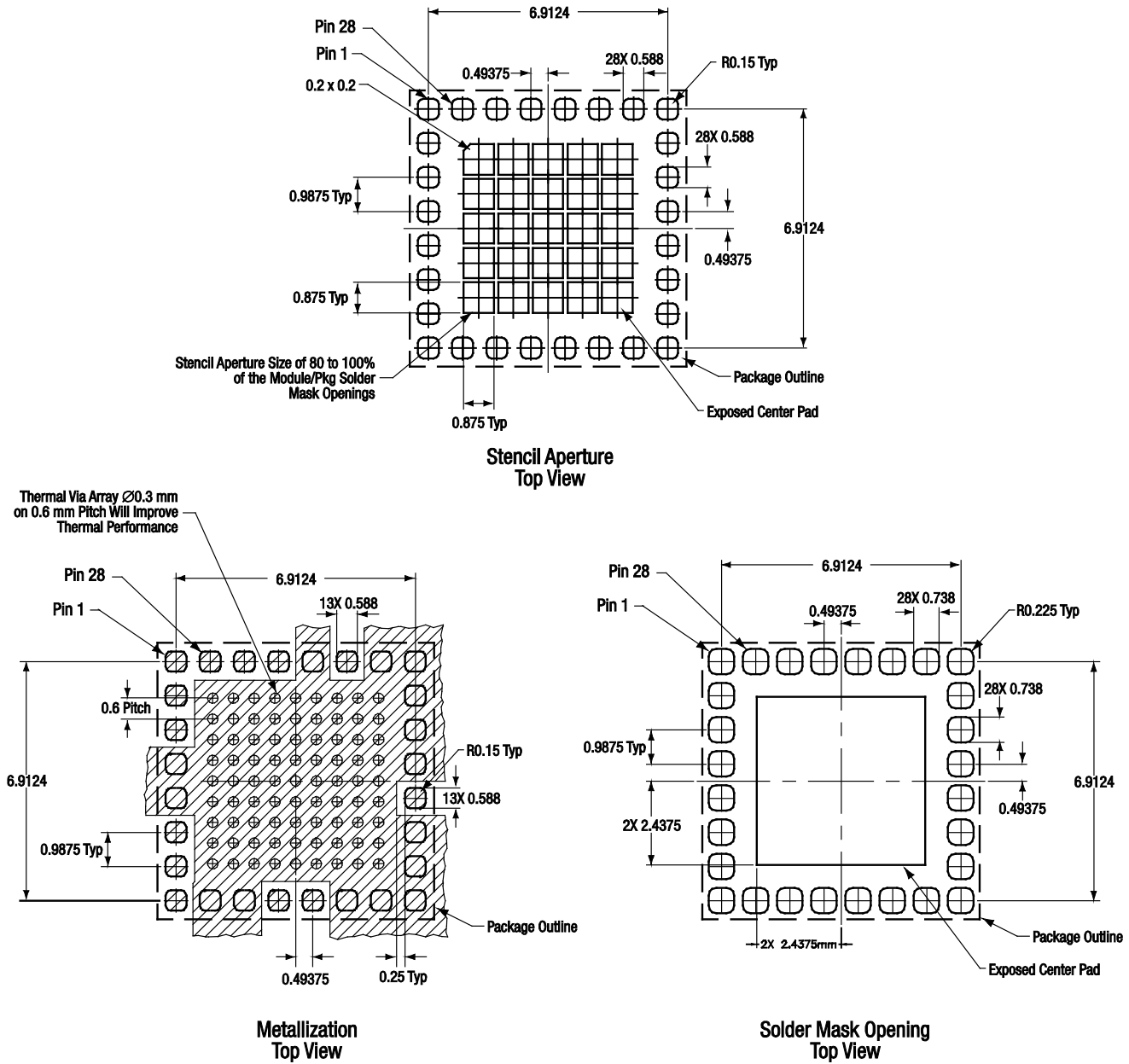

Figure 14. SKY65336-11 Evaluation Board Assembly Drawing

81291



All measurements are in millimeters

S1330

Figure 15. SKY65336-11 PCB Layout Footprint

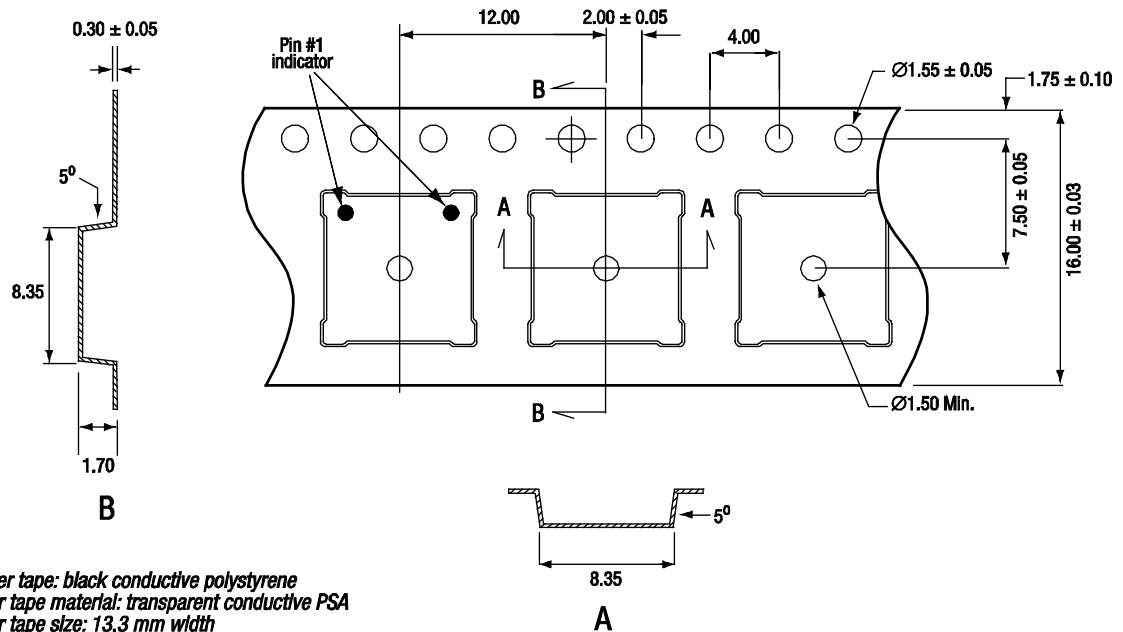

Notes:

1. Carrier tape: black conductive polystyrene
2. Cover tape material: transparent conductive PSA
3. Cover tape size: 13.3 mm width
4. All dimensions are in millimeters
5. Pin 1 orientation is in top left corner for the following Skyworks products:

SKY74963-xx
 CX74063-35
 SKY77503-xx
 SKY77506-xx
 SKY77512-xx
 SKY77526-xx
 SKY77343-xx

For all other 8 x 8 mm MCM/RFLGA products, pin 1 orientation is in top right corner.

S1290

Figure 17. SKY65336-11 28-Pin MCM Tape and Reel Dimensions

Ordering Information

Model Name	Manufacturing Part Number	Evaluation Board Part Number
SKY65336-11 Tx/Rx FEM w/LNA	SKY65336-11	TW17-D475-001

Copyright © 2008, 2009, 2011 Skyworks Solutions, Inc. All Rights Reserved.

Information in this document is provided in connection with Skyworks Solutions, Inc. (“Skyworks”) products or services. These materials, including the information contained herein, are provided by Skyworks as a service to its customers and may be used for informational purposes only by the customer. Skyworks assumes no responsibility for errors or omissions in these materials or the information contained herein. Skyworks may change its documentation, products, services, specifications or product descriptions at any time, without notice. Skyworks makes no commitment to update the materials or information and shall have no responsibility whatsoever for conflicts, incompatibilities, or other difficulties arising from any future changes.

No license, whether express, implied, by estoppel or otherwise, is granted to any intellectual property rights by this document. Skyworks assumes no liability for any materials, products or information provided hereunder, including the sale, distribution, reproduction or use of Skyworks products, information or materials, except as may be provided in Skyworks Terms and Conditions of Sale.

THE MATERIALS, PRODUCTS AND INFORMATION ARE PROVIDED “AS IS” WITHOUT WARRANTY OF ANY KIND, WHETHER EXPRESS, IMPLIED, STATUTORY, OR OTHERWISE, INCLUDING FITNESS FOR A PARTICULAR PURPOSE OR USE, MERCHANTABILITY, PERFORMANCE, QUALITY OR NON-INFRINGEMENT OF ANY INTELLECTUAL PROPERTY RIGHT; ALL SUCH WARRANTIES ARE HEREBY EXPRESSLY DISCLAIMED. SKYWORKS DOES NOT WARRANT THE ACCURACY OR COMPLETENESS OF THE INFORMATION, TEXT, GRAPHICS OR OTHER ITEMS CONTAINED WITHIN THESE MATERIALS. SKYWORKS SHALL NOT BE LIABLE FOR ANY DAMAGES, INCLUDING BUT NOT LIMITED TO ANY SPECIAL, INDIRECT, INCIDENTAL, STATUTORY, OR CONSEQUENTIAL DAMAGES, INCLUDING WITHOUT LIMITATION, LOST REVENUES OR LOST PROFITS THAT MAY RESULT FROM THE USE OF THE MATERIALS OR INFORMATION, WHETHER OR NOT THE RECIPIENT OF MATERIALS HAS BEEN ADVISED OF THE POSSIBILITY OF SUCH DAMAGE.

Skyworks products are not intended for use in medical, lifesaving or life-sustaining applications, or other equipment in which the failure of the Skyworks products could lead to personal injury, death, physical or environmental damage. Skyworks customers using or selling Skyworks products for use in such applications do so at their own risk and agree to fully indemnify Skyworks for any damages resulting from such improper use or sale.

Customers are responsible for their products and applications using Skyworks products, which may deviate from published specifications as a result of design defects, errors, or operation of products outside of published parameters or design specifications. Customers should include design and operating safeguards to minimize these and other risks. Skyworks assumes no liability for applications assistance, customer product design, or damage to any equipment resulting from the use of Skyworks products outside of stated published specifications or parameters.

Skyworks, the Skyworks symbol, and “Breakthrough Simplicity” are trademarks or registered trademarks of Skyworks Solutions, Inc., in the United States and other countries. Third-party brands and names are for identification purposes only, and are the property of their respective owners. Additional information, including relevant terms and conditions, posted at www.skyworksinc.com, are incorporated by reference.